

namco®

WORLD KICKS 2

**GAME CONTROLS
ADJUSTMENTS
AND PARTS**

The World Kicks 2 kit of parts consists of the following:

Item	Quantity	Part No.
World Kicks 2 Player Naomi PCB	1	XWK2P
V226 IF PCB	1	XWK-IFPCB
Amplifier 2 PCB	1	XTC-AMPCB
Power Supply MPU150-4530	1	83000014
Joystick Assy	2	47000186
Football Button Kick PCB	2	XWK2P-698-618
Football Button Cap	2	XWK2P-698-605
Football Button Bezel	2	XWK2P-698-606
Football Button Shaft	2	XWK2P-698-607
Football Button Spring	2	XWK2P-698-610
Football Button Bezel Lock Nut	2	XWK2P-698-612
USB Harness	1	X665-667
World Kicks 2 Player Universal Top Decal;	1	40000595
World Kicks 2 Player Instruction Decal (A & B)	1	40000596
Potentiometer (EWSV7CF20E130	1	X008-023
Kicker Bracket Drawing (BLE 592)	1	--- --
Game Controls, Adjustments and Parts Sheets	1set	--- --

Contents

1. HOW TO PLAY	4
Controls	4
Game Rules	4
Game Start Procedure	5
Buy-in (Joining the game midway)	5
2. Adjustment Switches	6
2-1 Test Mode	6
2-1-2 Display Test	7
2-1-3 I/O Test	8
2-1-4 Sound Test	11
2-1-5 Game Options	12
2-1-6 Coin Options	14
2-1-7 ADS Data	15
2-1-8 Data Clear	15
3. INITIALIZATION	16
4. PARTS	17
5. SCHEMATIC	18

1. HOW TO PLAY

This is a soccer game, which is played using analogue joysticks and a ball button switches as input devices. Up to 2 people can play on one machine, and up to 4 people can play using two machines interconnected. (Interconnection facilities are an optional extra). When a single player plays, the player competes against the CPU in a tournament, while multiple players can either compete against each other in two teams (Player mode) or compete together against the CPU (CPU mode).

Controls

1. Joystick
 - The direction that the joystick is moved determines the direction that the player on the screen moves and the direction that the ball is passed or shot.
 - The amount the joystick is moved from the upright position determines how fast the player on the screen moves.
2. Ball Button
 - Tap the ball button to pass or shoot and to tackle an opposing player.
 - The speed of the pass or shot is determined by how hard the ball button is tapped, the harder the tap the faster the pass or shot.
3. Change Button
 - Changes the screen player to be controlled during the game.
 - When shooting, press the Ball Button whilst holding the Change Button and with the Joystick returned to center to make a Loop Shot.
4. Start Button
 - Starts the game.
 - Enters the options on the start-up screen.

Game Rules

1. The team scoring the most goals during the match period (adjustable in test mode) wins.
2. If the match ends in a draw after the normal game period, the game enters an extended period (adjustable in test mode). This extended period is a "Golden Goal" format in which the first team to score wins.
3. If after the extra time the score is still a draw, the game will go into a PK-match. The PK-match is a best of 5 Penalty Shoot-out.
 - * The setting of the PK-match can be changed in the Test mode.
 - * When the PK-match is set to [NORMAL] and the score is still equal after the penalties a *sudden death* match will be played.
 - * When the PK-match is set to [3 or 5] and the score is still a draw after the penalties the match will be deemed a draw and rth game will be over,
4. If the ball goes out of play, the opposing team makes a kick-in, a corner kick, or a goal throw to resume play.

5. When the play is stopped for a foul, the play is restarted by selecting a FREE KICK or a PENALTY.
6. The game can be played in "CPU mode" or "Head to Head mode".
The game is played in CPU mode if only a single player plays, or all players select the same team.
7. In CPU mode, The players compete in a knockout tournament format progressing from the first round through to the final. If a player loses in CPU mode, they have the option to continue a new game against the same team.
8. In Head to Head mode, the teams compete to score against each other. The winners go on to compete against the CPU, or the losing team have the option to begin a new match depending on the setting of the 'Game Option Return Match Setting'. (This option is set in Test mode)
Return Match = OFF: Winner in Head to Head mode goes on to compete in CPU mode.
Return Match = ON: Loser in Head to Head mode can resume a new match against the winner.
9. Players can join in a game midway even when other players are already playing.

Game Start Procedure

1. Entry
 - ✿ Insert coin/s to establish credit/s and press the start button at the player position to be used.
2. Field Selection
 - ✿ Use the joystick to select which half of the pitch (or team) the player wants and press the start button.
3. Team Select
 - ✿ Use the joystick to select a country and press the start button.
 - * If two or more players are to play on the same team, the first player to enter decides which country is chosen.
 - * The same country cannot be chosen for opposing teams.
4. Control Instructions
 - ✿ Instruction for the use of game controls will be displayed on the screen prior to the start of the match.

Buy-in (Joining the game midway)

- ✿ To join in a game already in progress, enter coin/s to establish credit and press the start button at the player position to be used. Use the joystick to select which half of the pitch (or team) to join and press the start button.

2. Adjustment Switches

Two switches are required to operate the Test Options.

1. Service Switch.
Press this switch to obtain game credits without incrementing the play meter, and to select an item in the Test Menu.
2. Test Switch
Press the test switch to enter test mode, and to enter the selected item in the Test Menu.

2-1 Test Mode

1. Open the coin door and slide the test switch "ON". The "Menu Screen" will be displayed on the monitor.
2. Operating the Service Switch will step through the tests. Select the test required by pressing the Test Switch.
3. After testing is completed, return to this menu screen, select EXIT with the Service switch and press the Test switch to return to normal game mode.

MENU

LOADED SOFTWARE : WKC2 / ver.A
S/N : ##### - #####

DISPLAY TEST	_____	For monitor adjustment
I/O TEST	_____	For testing switches and controls
SOUND TEST	_____	For setting the volume
JVS CABINET OPTIONS	_____	Not Used
GAME OPTIONS	_____	For setting options of the game
COIN OPTIONS	_____	For setting game pricing, etc.
ADS DATA	_____	For displaying game data
DATA CLEAR	_____	For initializing backup memory.
EXIT		

SELECT: SERVICE SW ENTER:TEST SW

2-1-2 Display Test

1. Select "MONITOR TEST" on the menu screen to test and adjust the Monitor. The following screen is displayed.
2. Use the Service switch to choose the required item then press the Test switch. To return to the Monitor Test Menu from a test pattern press the Test switch.
3. Select "EXIT" and press the Test switch to return to the menu screen.

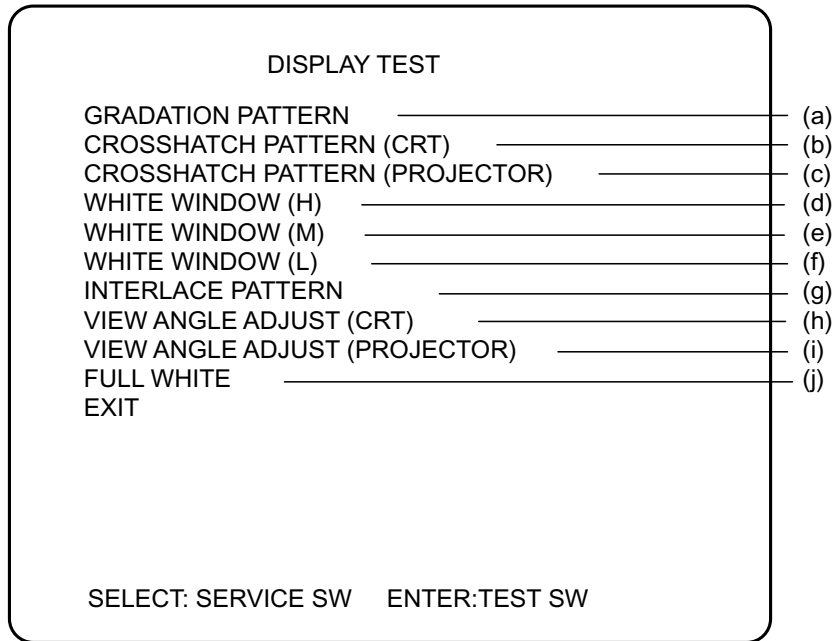

- a) Displays a colour gradation pattern.
- b) Displays a crosshatch pattern for CRT monitors.
- c) Displays a crosshatch pattern for projectors. (not used on this game)
- d) Displays a white square. (H or light)
- e) Displays a white square. (M or medium)
- f) Displays a white square. (L or dark)
- g) Displays an interlace pattern.
- h) Displays an adjustment screen for CRT monitors.
- i) Displays an adjustment screen for projectors. (Not used on this game)
- j) Displays an entire white screen.

2-1-3 I/O Test

1. Select "I/O TEST" on the menu screen to check I/O PCB and Switches. The following screen is displayed.
2. Use the Service button to choose the required item then press the Testbutton.
3. Use the Select Up/Down switch to change the setting.
4. Select "EXIT" and press the Enter button to return to the menu screen.

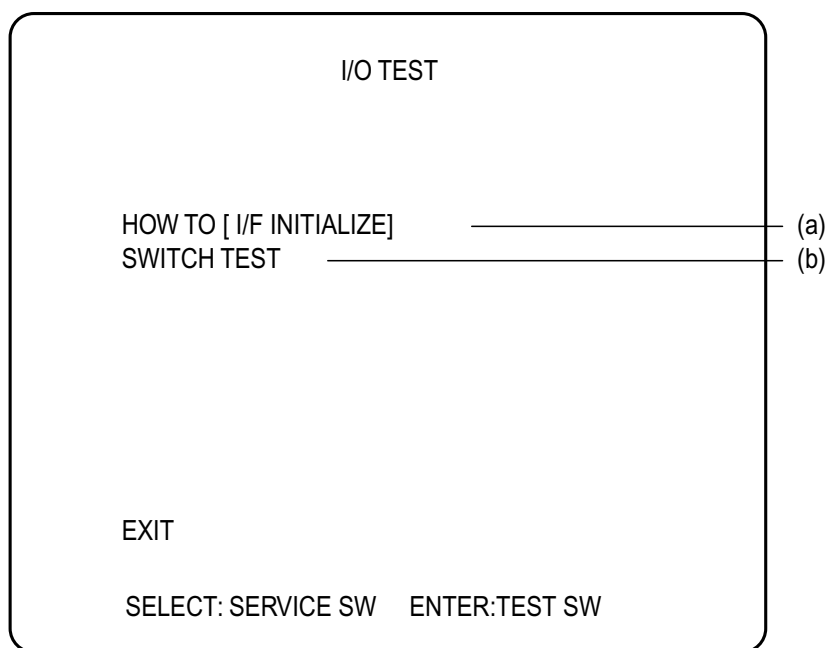

(a) How to I/F Initialize.

When item (a) is selected the following screen is displayed

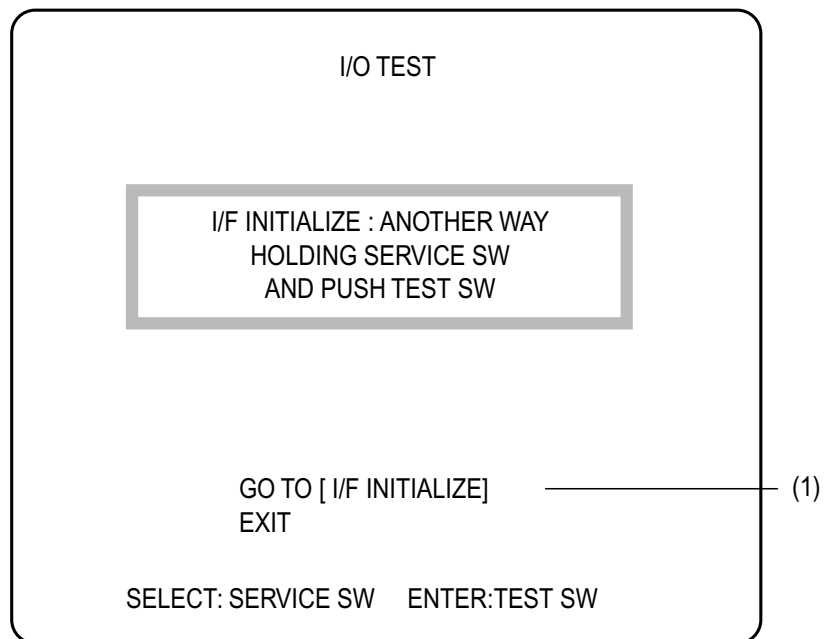

1. When item 1 (GO TO [I/F INITIALIZE]) is selected the following screen is displayed.

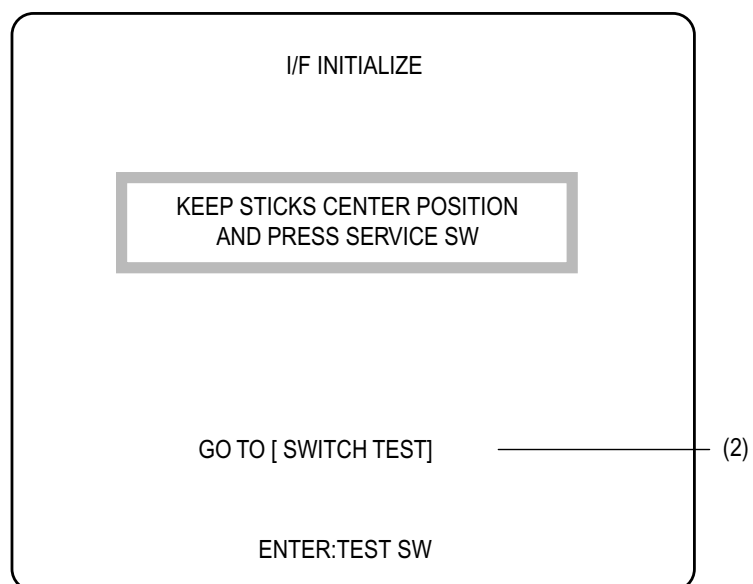

2. When item 2 (GO TO [SWITCH TEST]) or item (b) from the I/O Test screen is selected, the following screen is displayed.

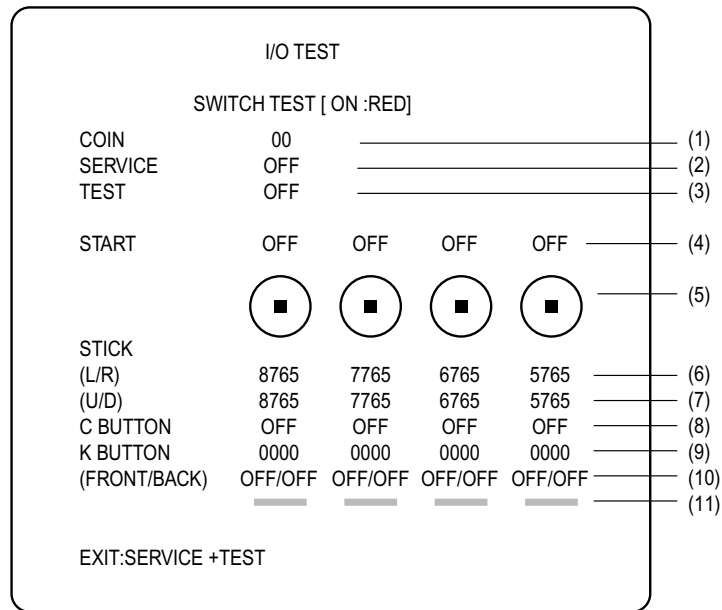

The SWITCH TEST screen displays the status of the switches. The display changes when any of the switches are operated. Press both Service button and Test button together to exit and return to the Menu.

- (1) The number increments each time a coin signal is received.
- (2) ~ (4) The display changes from OFF to ON each time the respective switch is operated.
- (5) A bar extends from the centre corresponding to the direction and deflection of the joystick.
- Analog lever movement

Indication on the screen

A bar extends in a direction which the lever is tilted.
- (6) & (7) The figure changes corresponding to the joystick angle when the joystick is tilted. The figure will change colour when the joystick is tilted to its maximum angle of deflection. (7) is for the left/right direction, and (8) is for the forward/backward direction.
- (8) The display changes from OFF to ON when either of the Change buttons are pressed.
- (9) Displays the input force of the ball assembly used during the game.
- (10) The left OFF changes to ON, (ON/OFF), when the ball button is pressed gently and the right OFF changes to ON, (ON/ON), when the ball button is pressed hard.
- (12) A red bar is displayed above the line when the ball button is pressed. The bar length indicates the kick speed.

2-1-4 Sound Test

1. Select "SOUND TEST" on the menu screen to adjust the volume and test the sound. The following screen is displayed.
2. Use the Service button to choose the required item then press the Test button.
3. Use the Test button to change the selected item settings
Note: Item (c) only. To select the digit to be adjusted press the Service button. To change the digit number press the Test button. Press the Player 1 Start Button to produce the sound selected.
4. Select "EXIT" and press the Test button to return to the menu screen.

SOUND TEST		
[DEFAULT IN GREEN]		
ATTRACT SOUND	ON	(a)
SPEAKER OUT	STEREO	(b)
REQUEST SONG NO.	000	(c)
MESSAGE	STEREO CHECK	(d)
EXIT		
CHOOSE: SERVICE SW ENTER:ENTER SW		
REQUEST ON/OFF: P1 - START		

- (a) Attract sound ON or OFF
- (b) Selects sound output as ON - stereo or OFF - mono
- (c) Each number will produce a different sound each time the Player 1 Start switch is pressed. (for a maximum of 10 seconds.)
000 when selected will produce a sound from the left speaker only, then the right speaker only and then both speakers together as a stereo check.
- (d) Displays the sound code selected by REQUEST. "NO SOUND" is displayed if there is no corresponding sound file for the selected number

2-1-5 Game Options

1. Select "GAME OPTIONS" on the menu screen to set the game settings. The following screen is displayed.
2. Use the Service button to choose the required item then press the Test button.
3. Use the Service button to change the setting and press the Test button to return to item selection.
4. Select "EXIT" and press the Test button to return to the menu screen.

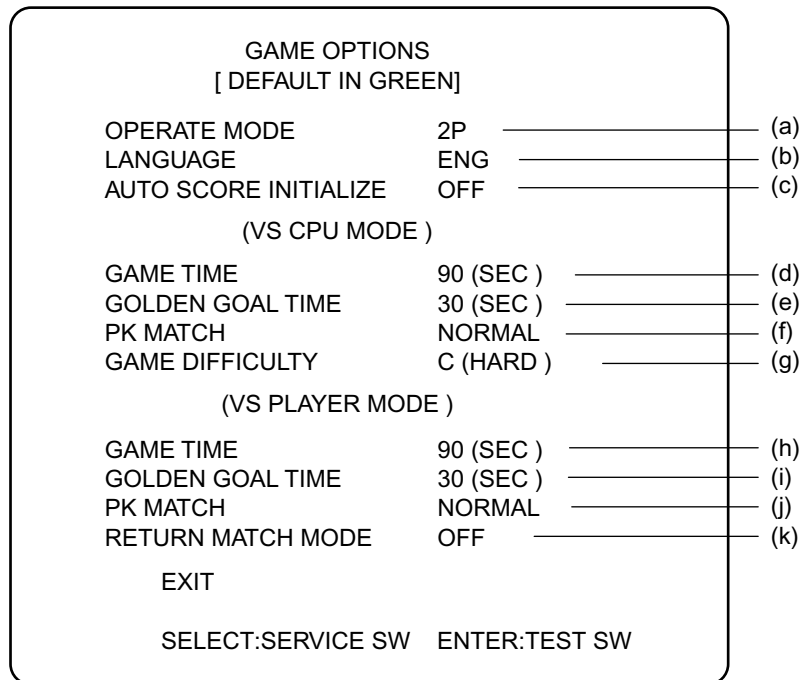

Item	Description	Factory Set
(a)	Play Mode Setting (see note 1 below)	1
(b)	Language: ENG (English), FRA (French), GER (German), ESP (Spanish), ITA (Italian), KOR (Korean), CHN (Chinese) (see note 2 below)	ENG
(c)	Auto Score Initialize: ON/OFF (When ON high score initialized at game power up)	OFF

NOTES:

1. *Play mode setting is automatic. 2P for single cabinet play / 2P ON 2P for two cabinets linked.*
2. *Only the instructions of how to kick the ball during the attract mode are available in the selected language, All other texts shown on the screen are in English.*

Item	Description	Factory Set
(d)	Game Time Setting in CPU-Match 30, 60, 90, 120, 150, 180, 240, 300 secs	90
(e)	Golden Goal Time setting in CPU-Match 15, 30, 60, 90 secs OFF, NO LIMIT	30
(f)	PK-match setting in CPU-Match NORMAL, 3SET, 5SET,OFF	NORMAL
(g)	Game Difficulty Setting in CPU-Match A(Easy), B(Normal), C(Hard), D(V.Hard)	C: HARD
(h)	Game Time Setting in Head-to-Head Match 30, 60, 90, 120, 150, 180, 240, 300 secs	90
(i)	Golden Goal Time setting in Head-to-Head Match 15, 30, 60, 90 secs OFF, NO LIMIT	30
(j)	PK-match setting in Head-to-Head Match NORMAL, 3SET, 5SET,OFF	NORMAL
(k)	Return Match Setting ON / OFF	OFF

2-1-6 Coin Options

1. Select "COIN OPTIONS" on the menu screen to set the game cost and related settings. The following screen is displayed.
2. Use the Service button to choose the required item then press the Test button.
3. Use the Service button to change the setting and press the Test button to return to item selection.
4. Select "EXIT" and press the Test button to return to the menu screen.

Note:- If the cabinet is fitted with a CashFlow Acceptor the price of play is set within the Cashflow Coin Mech. Ensure that the Game Cost is set to 1 Coin 1 Credit.

COIN OPTIONS
[DEFAULT IN GREEN]

GAME COST	1 COIN(S) 1 CREDIT	(a)
CONTINUE COST	1 COIN(S) 1 CREDIT	(b)
RETURN MATCH COST	1 COIN(S) 1 CREDIT	(c)
FREE PLAY	OFF	(d)
1 CREDIT FOR 2 PLAYERS	ON	(e)
COIN SHUTE1 MECHANICAL VALUE	1COIN COUNT AS 1 CREDIT	(f)
COIN SHUTE2 MECHANICAL VALUE	1COIN COUNT AS 1 CREDIT	(g)
CREDIT MODE	EACH ONE	(h)
COIN COUNTER	2COUNTER(S)	(i)

EXIT

SELECT: SERVICE SW ENTER:TEST SW

Item	Description	Factory Set
(a)	Number of credits required for 1 game play	1
(b)	Number of credits required for a continue play (see note 1 below)	1
(c)	Number of credits required for return match	1
(d)	Free Play setting ON /OFF (see note 2 below)	OFF
(e)	1 credit for 2 person play ON / OFF (see note 3 below)	OFF
(f)	Number of credits established for 1 coin (left chute) (see note 4 below)	1
(g)	Number of credits established for 1 coin (right chute) (see note 4 below)	1
(h)	Credit Mode COMMON / EACH ONE (see note 5 below)	COMMON

NOTES:

1. *The Continue price and the Return Match price cannot be greater than the normal price of play.*
2. *When Free Play is set to ON, press the start buttons to start a game.*
3. *When 1 credit for 2 players is set to ON, both players can play with 1 credit.*
4. *Left and Right chutes only available with mechanical coin mechanisms.*
5. *This is automatically set if a second cabinet is linked.*

2-1-7 ADS Data

This screen is used to view the various bookkeeping data for the game.

Data can only be reset from the DATA Clear option on the Main Menu screen.
(see 2-1-7 page 13)

After checking the bookkeeping data, select EXIT and press the Test button to return to the Main Menu screen.

2-1-8 Data Clear

1. Select "DATA CLEAR" on the menu screen to set the game cost and related settings. The following screen is displayed.
2. Use the Service button to choose the required item then press the Test button.
3. Use the Service button to select YES /NO and press the Test button to clear the data for that item.
4. Select "EXIT" and press the Test button to return to the menu screen.

The screenshot shows a menu titled "DATA CLEAR" with the following options and labels:

- ADS DATA CLEAR (a)
- RANKING CLEAR (b)
- SET DEFAULTS ALL OPTIONS (c)
- ALL CLEAR (d)
- GOTO NAOMI TEST MODE (e)
- EXIT (f)

At the bottom of the screen, it says: SELECT: SERVICE SW ENTER: TEST SW

- (a) Initializes the ADS Data
- (b) Initializes the Top Score Ranking Data
- (c) Returns Game and Coin options to default setting.
- (d) Initializes all data (a, b, c above)
- (e) Enters the PCB Internal Test.
- (f) Returns to the Main Menu Screen

3. INITIALIZATION

Adjustments when Replacing Parts

The following operation must always be performed after replacing the NAOMI Game PCB, Joystick Potentiometers or initializing the backup data..

The game will not operate correctly if these adjustments are not made.

1. Press the Test and Service buttons together. The following screen is displayed.

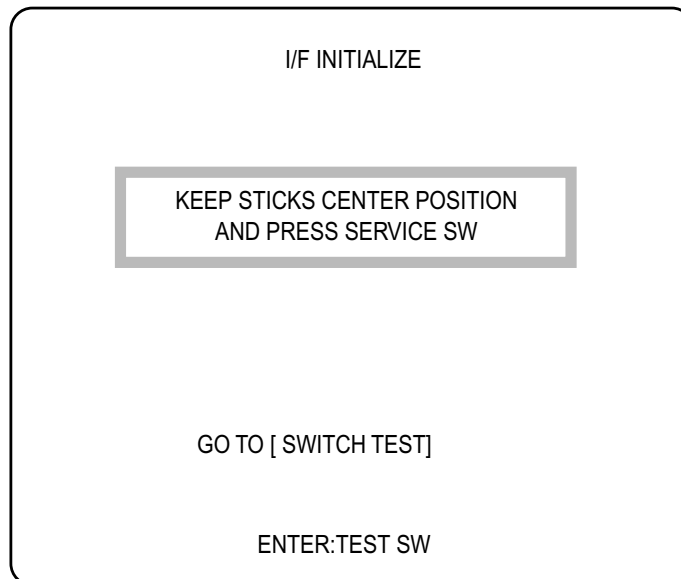

2. Ensure that all joysticks are in their central position, then press the Service button to initialize the setting details.
3. Press the test button to go to the Switch Test and confirm correct joystick operation. (see page 10 for test details)

4. PARTS

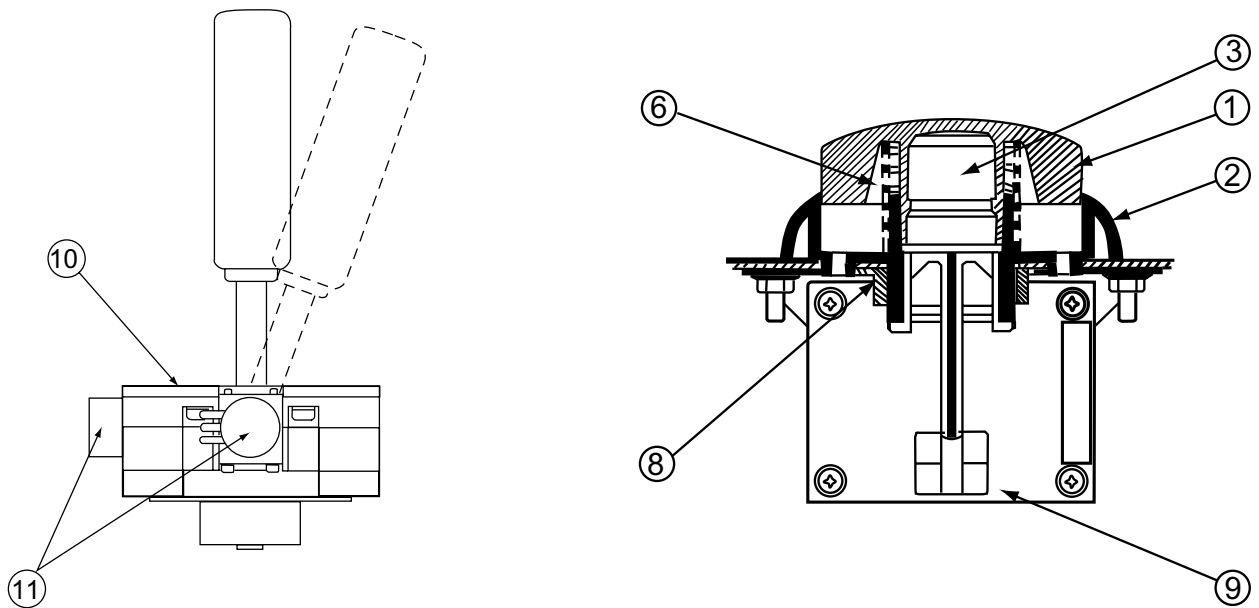

Item	Description	Part No
1	Button Cap	XWK2P-698-605
2	Button Bezel	XWK2P-698-606
3	Button Shaft	XWK2P-698-607
6	Button Spring	XWK2P-698-610
8	Lock Nut	XWK2P-698-612
9	Kick PC Board	XWK2P-698-618
10	Joystick Assy	47000186
11	Potentiometer	X008-023

PARTS NOT SHOWN

Item	Description	Part No
	World Kicks 2 Player Universal Top Decal	40000595
	World Kicks 2 Player Instruction Decal	40000596
	USB Harness (Internal)	X665-667
	SwitchMode Power Supply (MPU-150)	83000014
	World Kick 2 Player Naomi PCB	XWK2P-GAMEPCB
	V226 IF PCB	XWK-IFPCB
	Amplifier 2 PCB	XTC-AMPCB

WORLD KICKS 2 PLAYER

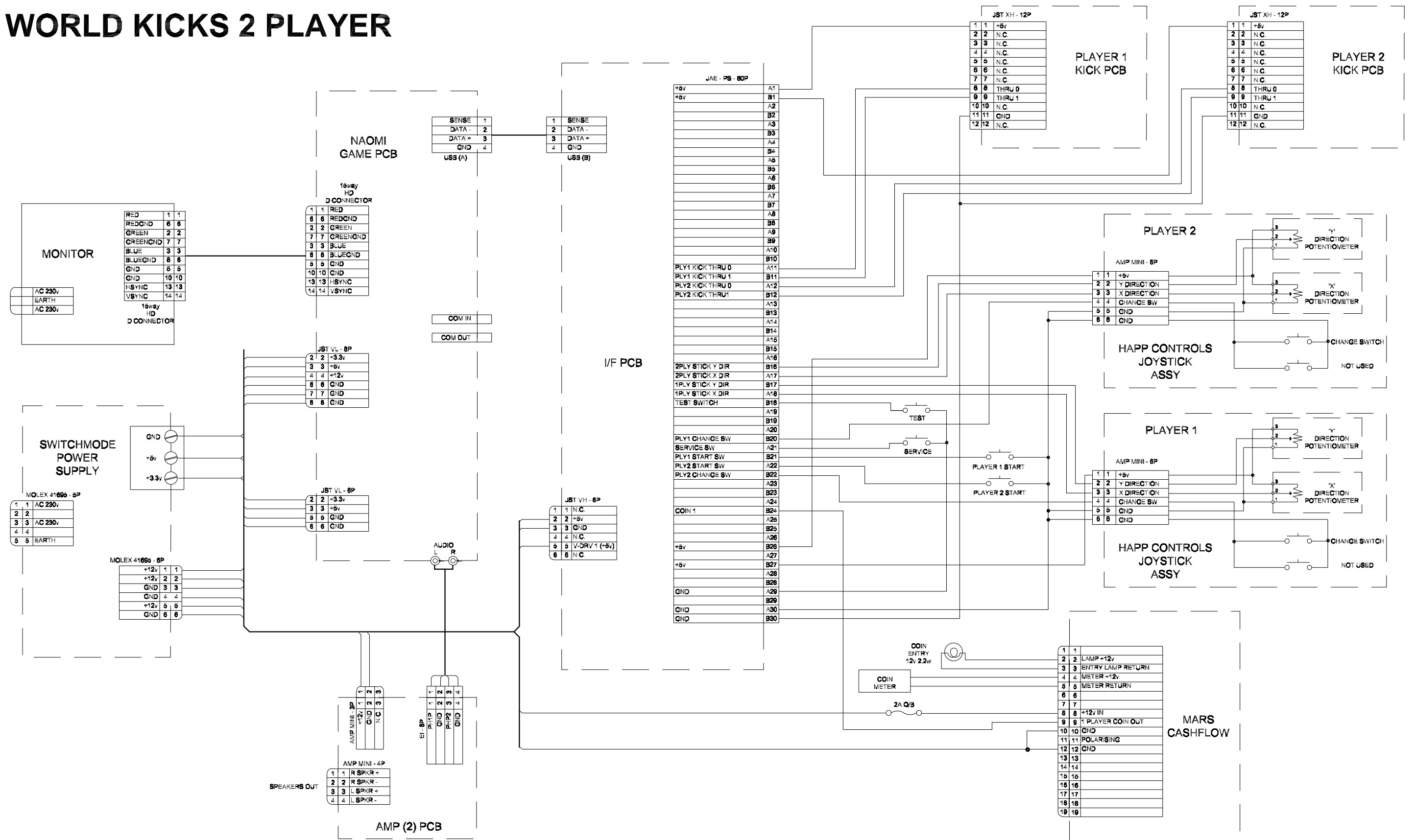

For all Parts or Technical Support contact:

Brent Spares,
Namco House,
Units 5-8, Acton Park Estate,
The Vale,
London. W3 7QE

Web Site: <http://www.Namco.co.uk>

For Technical Support, Warranty and
Advance Replacement Parts: ☎ +44 (0)20 8324 6120
For Consumable Parts: ☎ +44 (0)20 8324 6102
Fax for both: +44 (0)20 8324 6126