

COLOR RASTER DISPLAY MONITOR

INSTRUCTION MANUAL

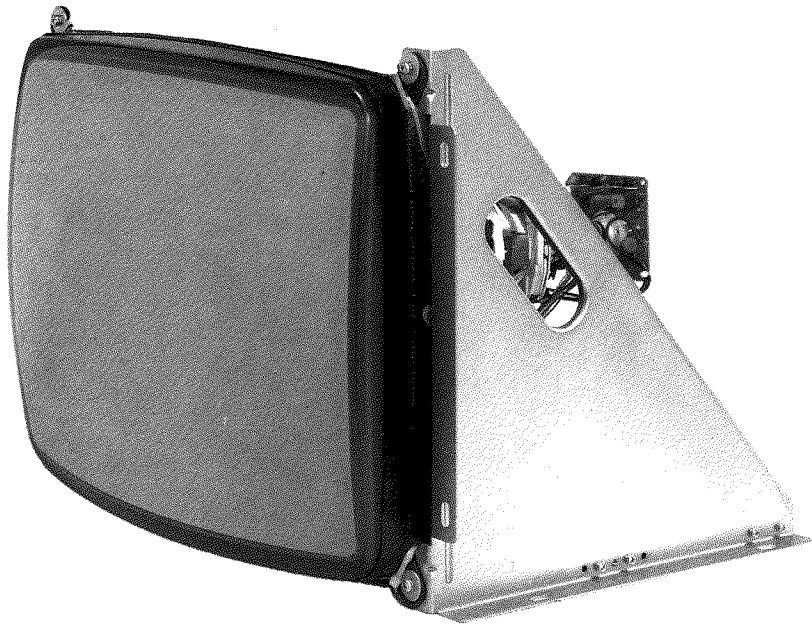

TABLE OF CONTENTS

TABLE OF CONTENTS.....	2
SAFETY PRECAUTIONS.....	3
X-RAY RADIATION PRECAUTIONS.....	3
PERFORMANCE AND OPERATING DATA.....	4
CIRCUIT DIAGRAM.....	5
SERVICE INSTRUCTIONS.....	6
CIRCUIT ADJUSTMENTS.....	6
CONVERGENCE ADJUSTMENTS.....	8
P.C. BOARD LAYOUT.....	11
PARTS LIST.....	13

1. SAFETY PRECAUTIONS

WARNING: Service should not be attempted by anyone unfamiliar with the necessary precautions on this monitor.

The followings are the necessary precautions to be observed before servicing.

- 1) An isolation transformer must be used between the AC supply and the AC plug of the monitor before servicing or testing is performed since the chassis and the heat sink are directly connected to one side of the AC line which involves a shock hazard.
Before servicing is performed, read all the precautions labelled on the CRT and chassis.
- 2) Always discharge the picture tube anode to the CRT conductive coating before handling the picture tube.
The picture tube is highly evacuated and if broken glass fragments are violently expelled, use shatterproof goggles and keep picture tube away from the bare body while handling.
- 3) Potentials as high as 25Kvolts are present when this receiver is operating. Operation of the receiver outside the cabinet or with the back cover removed involves a shock hazard from the receiver.
 - a) Servicing should not be anyone who is not thoroughly familiar with the precautions necessary when working on high-voltage equipment.
 - b) Always discharge the picture tube anode to keep off the shock hazard before removing the anode cap.
 - c) Perfectly discharge the high potential of the picture tube before handling. The picture tube is highly evacuated and if broken glass fragments are violently expelled, use shatterproof goggles and keep picture tube away from the bare body while handling.
- 4) Wind the lead wires around terminals before soldering when replacing parts or circuit boards.
- 5) When replacing a high wattage resistor (oxide metal film resistor) in circuit board, keep the resistor 10mm always from circuit board.
- 6) Keep wires away from high voltage or high temperature components.

2. X-RAY RADIATION PRECAUTIONS

- 1) Excessive high voltage can produce potentially hazardous X-RAY RADIATION. To avoid such hazards the high voltage must not be above the specified limit. The nominal value of the high voltage of this receiver is 25Kv at zero beam current (minimum brightness) under a 120V AC power source.
The high voltage must not, under any circumstances, exceed 30Kv. Each time a receiver requires servicing, the high voltage should be checked following the HIGH VOLTAGE CHECK procedure on page P (11) of this manual. It is recommended the reading of the high voltage be recorded as a part of the service record. It is important to use an accurate and reliable high voltage meter.

- 2) The only source of X-RAY RADIATION in this receiver is the picture tube. For continued X-RAY RADIATION protection, the replacement tube must be exactly the same type tube as specified in the parts list.

3. PERFORMANCE AND OPERATING DATA

Apply a suitable power source to the monitor through an isolation transformer.

Set Up Controls

All controls are preset at the factory, but may be adjusted to suit program material.

- Supply
Voltage 105VAC-132VAC
Frequency 50HZ-60HZ
(Apply supply voltage through an isolation transformer with 1 Amp. minimum capability.)

SERVICE INSTRUCTIONS

All monitors are equipped with automatic degaussing coils which demagnetize the picture tube every time the monitor is turned on after being off for a minimum of 5 minutes. Should any part of the chassis become magnetized it will be necessary to degauss the affected area with a manual degaussing coil. Move the coil slowly around the CRT face area and all surrounding metal parts. Then slowly withdraw for a distance of 6 feet before turning off.

CIRCUIT ADJUSTMENT

- 1) 117V Power Supply Adjustment (Adjust R 607)
- 2) Horizontal Oscillator Adjustment (Adjust R402)
If there is an indication of unstable horizontal synchronization, adjust the Horizontal Hold Control (R402) to produce a stable picture.
- 3) Width Adjustment (Adjust L401)
If the picture of the screen is not adequately wide, adjust L401 to the width as required.
- 4) Horizontal Raster Position Adjustment (Adjust R420)
If the picture is off center horizontally some compensation can be made by adjusting R420 as required.
- 5) Vertical Oscillator Adjustment (Adjust R201)
If the picture moves up or down on the screen, adjust the Vertical Hold Control (R201) until there is a single picture on the screen.
- 6) Vertical Height Adjustment (Adjust R202)
Adjust Height Control (R202) to change the height of the picture or pattern.
- 7) Vertical Raster Position Adjustment (Adjust R203)
If the picture or pattern is off center vertically some compensation can be made by adjustment (R203) as required.
- 8) White Balance Adjustment (Adjust R105. R108. R106. R107. R109.)
If raster is not appeared white level as no pattern, adjust R105 R106 R107. R108. R109 to best white level.
- 9) Focus Adjustment (Adjust Focus VR)
Adjust focus control VR on focus pack for well defined scanning lines in the central area of the screen.
- 10) Brightness Adjustment (Adjust R104)
Adjustment of R104 may be necessary to obtain the proper black level. Do not use the screen control to set the black level.
- 11) Screen Adjustment (Adjust Screen VR on Focus Pack)
This control has been set at the factory and should not need further attention. If however it is necessary when the game is applied, adjust Screen VR on Focus Pack.

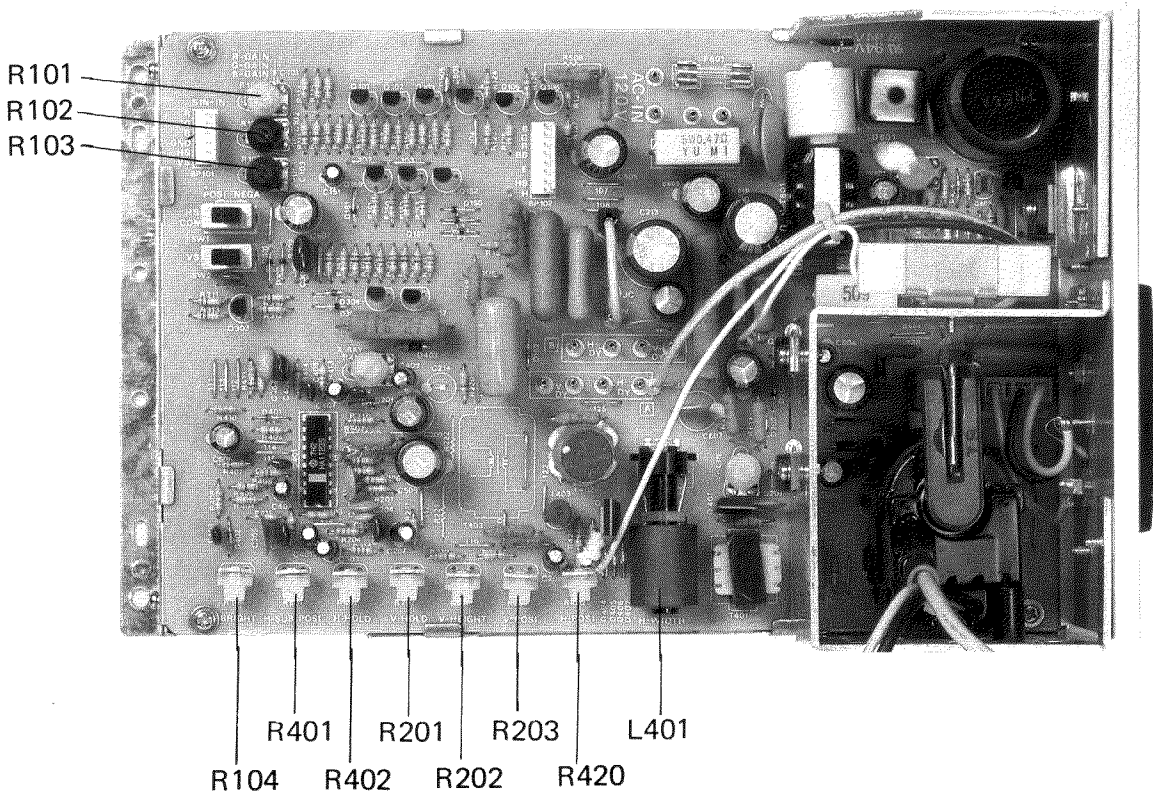
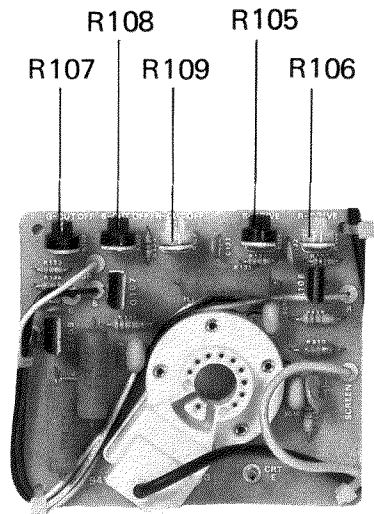

CONVERGENCE MAGNET ASSEMBLY POSITIONING

Convergence magnet assembly and rubber wedges need mechanical positioning following the figure 3.

COLOR PURITY ADJUSTMENT

NOTE: Before attempting any purity adjustments, the monitor should be operated for at least fifteen minutes.

- 1) Demagnetize the picture tube and cabinet using a degaussing coil.
- 2) Turn the BRIGHTNESS control to maximum.
- 3) Adjust RED and BLUE CUT controls (R108, R107) to provide only a green raster. Advance the GREEN CUT control (R109) is necessary.
- 4) Loosen the clamp screw holding the yoke, and slide the yoke backward to provide vertical green belt (zone) in the picture screen.
- 5) Remove the Rubber Wedges.
- 6) Rotate and spread the tabs of the purity magnet (see figure 4) around the neck of the picture tube until the green belt is in the center of the screen. At the same time, center the raster vertically.
- 7) Move the yoke slowly forward until a uniform green screen is obtained. Tighten the clamp screw of the yoke temporarily.
- 8) Check the purity of the RED and BLUE raster by adjusting the CUT controls.
- 9) Proceed with convergence adjustment.

CONVERGENCE ADJUSTMENT

NOTE: Before attempting any convergence adjustments, the monitor should be operated for at least fifteen minutes.

*CENTER CONVERGENCE ADJUSTMENT

- 1) Receive crosshatch pattern with a R.G.B. signal generator.
- 2) Adjust the BRIGHTNESS control for well defined pattern.
- 3) Adjust two tabs of the 4-pole magnets to change the angle between them (See figure 4) and superimpose RED and BLUE vertical lines in the center area of the picture screen. (See figure 5).
- 4) Turn both tabs at the same time keeping the constant angle to superimpose RED and BLUE horizontal lines at the center of the screen.(See figure 5).
- 5) Adjust two tabs of 6-pole magnets to superimpose RED and BLUE line with

GREEN one. Adjusting the angle affects the vertical lines and rotating dot magnets affects the horizontal lines.

- 6) Repeat adjustments 3,4,5 keeping in mind RED, GREEN and BLUE movement, because 4-Pole magnets and 6-Pole magnets interact and make dot movement complex.

CIRCUMFERENCE CONVERGENCE ADJUSTMENT

NOTE: This adjustment requires Rubber Wedge Kit

- 1) Loosen the clamping screw of deflection yoke to allow the yoke to tilt.
- 2) Place a wedge as shown in figure 3 temporarily. (Do not remove cover paper on adhesive part of the wedge.)
- 3) Tilt front of the deflection yoke up or down to obtain better convergence in circumference. (See figure 5) Push the mounted wedge into the space between picture tube and the yoke to hold to yoke temporarily.
- 4) Place other wedge into bottom space and remove the cover paper to stick.
- 5) Tilt front of the yoke right or left to obtain better convergence in circumference. (See figure 5).
- 6) Hold the yoke position and put another wedge in either upper space. Remove cover paper and stick the wedge on picture tube to hold the yoke.
- 7) Detach the temporarily mounted wedge and put it in another upper space. Stick it on picture tube to fix the yoke.
- 8) After placing three wedges, recheck overall convergence. Tighten the screw firmly to hold the yoke tightly in place.
- 9) Stick 3 adhesive tapes on wedges as shown in figure 3.

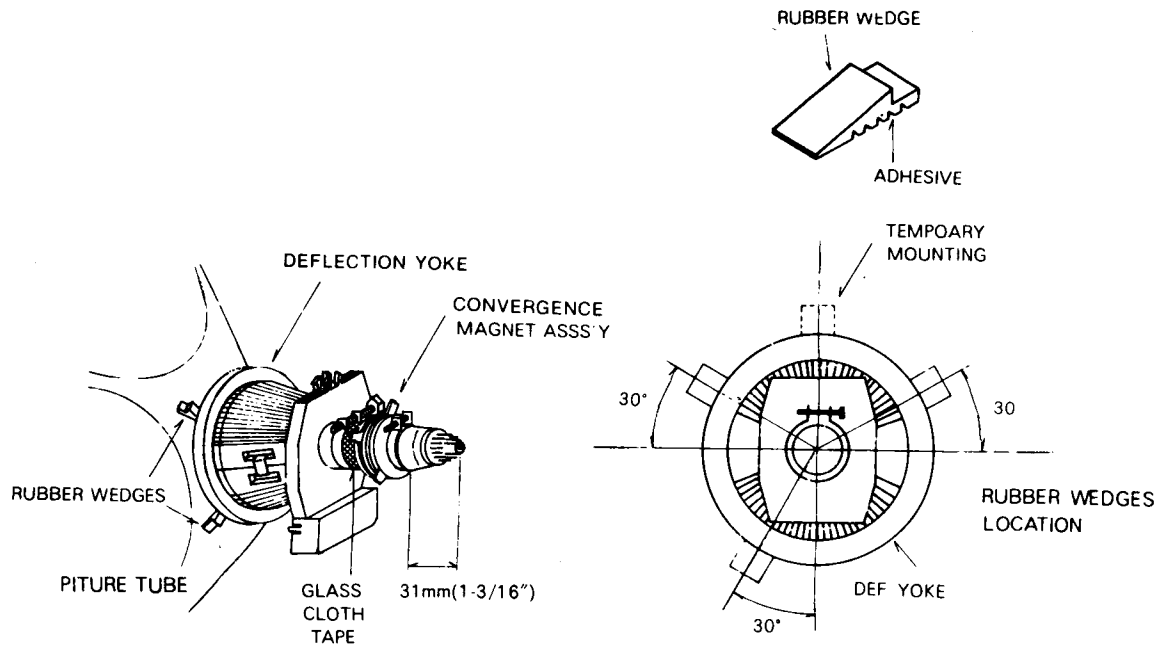

Fig. 3

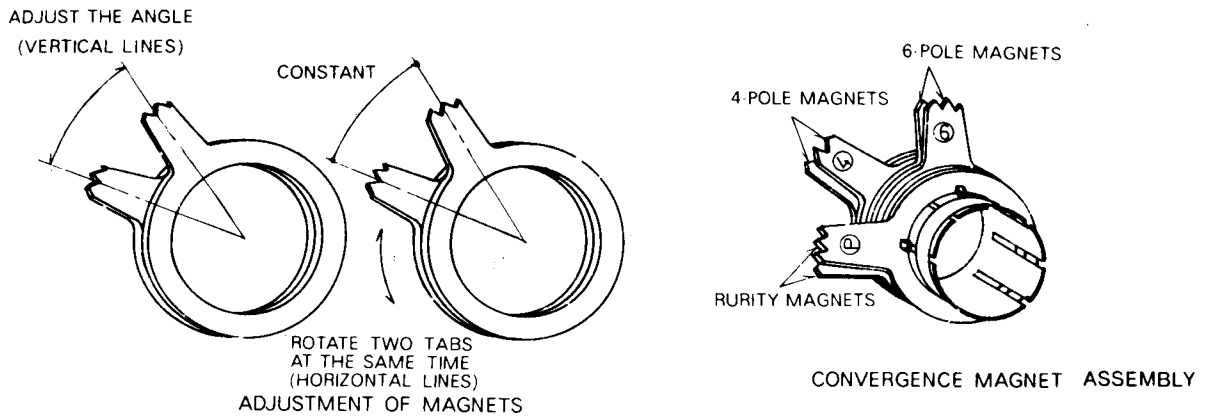

Fig. 4

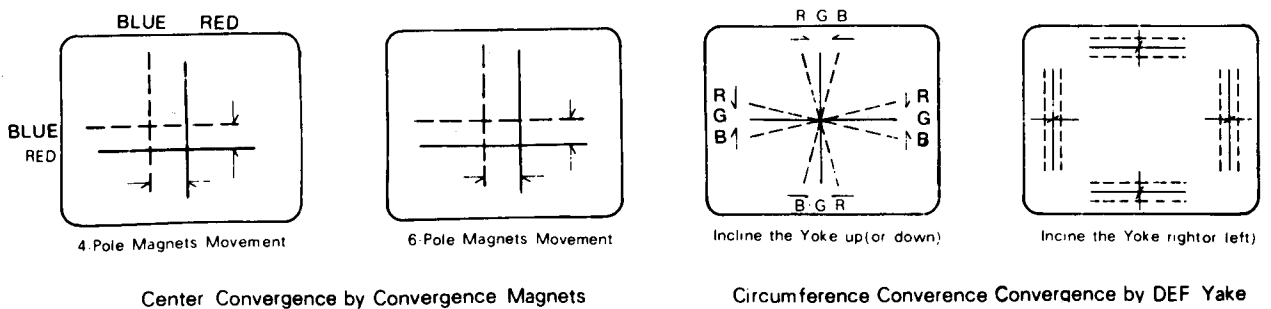
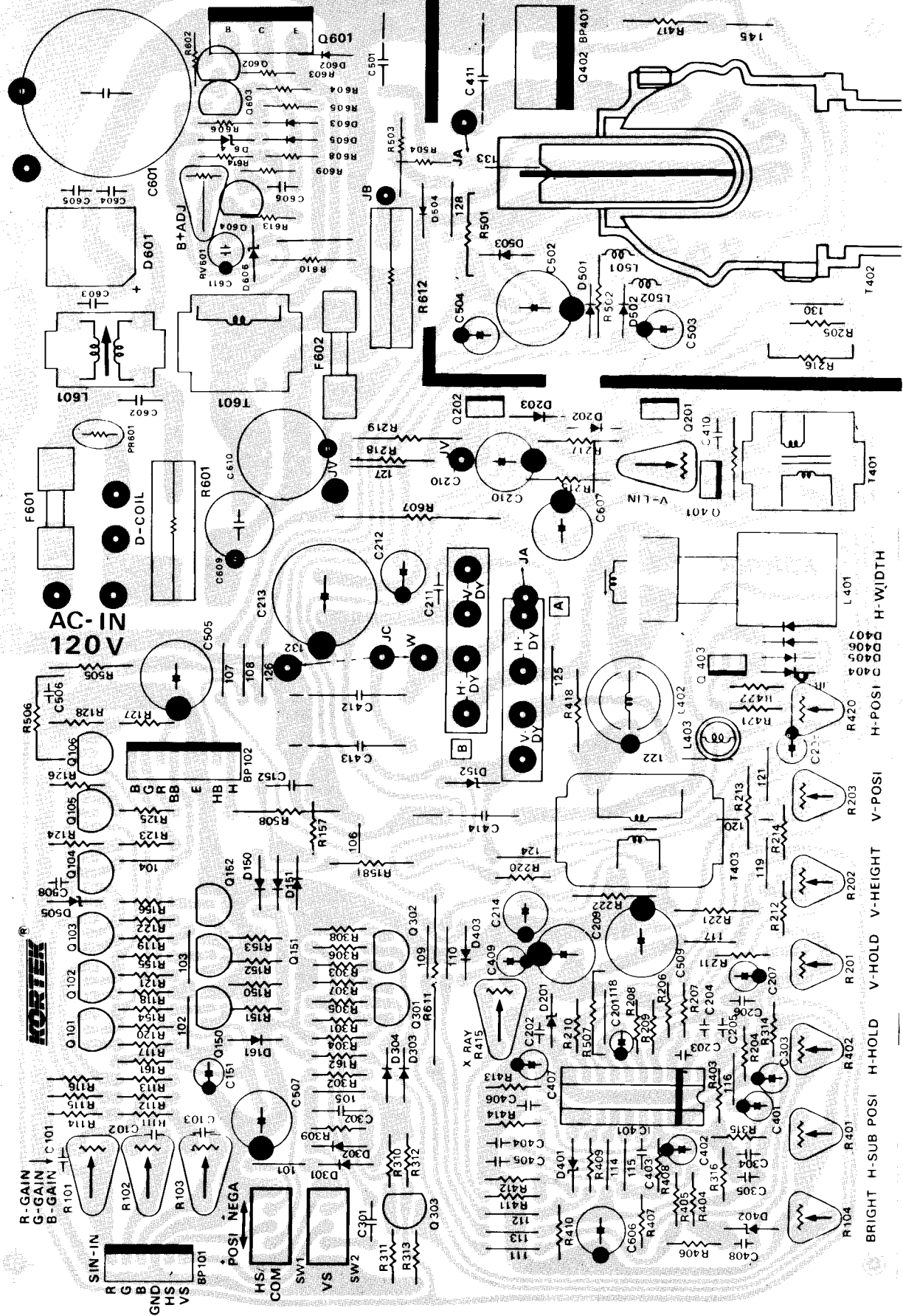
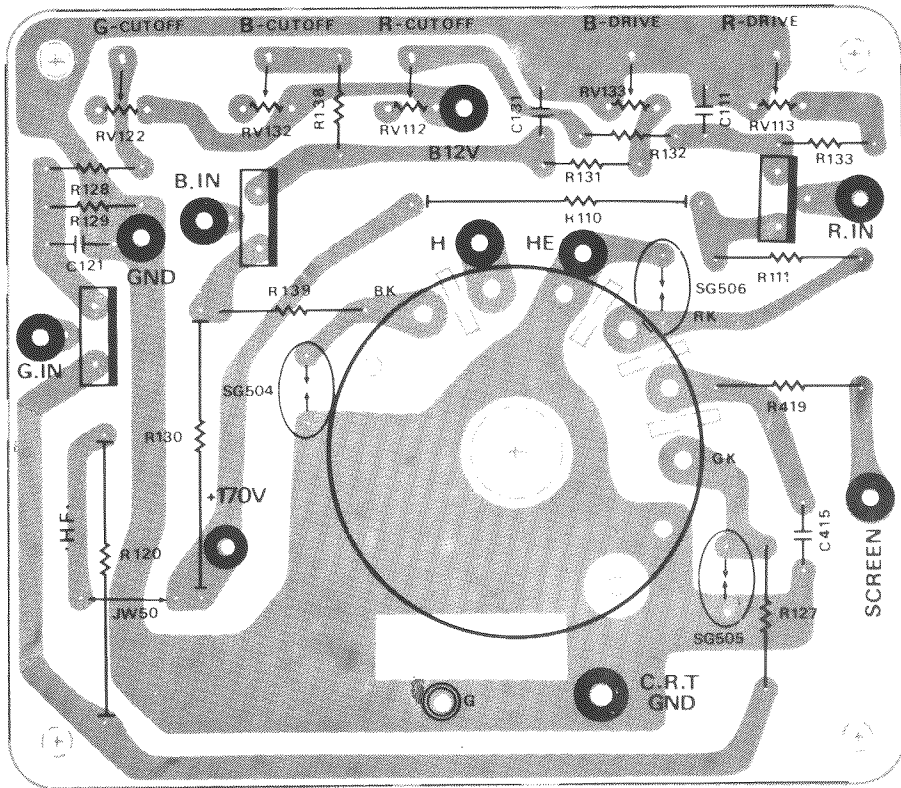

Fig. 5 Dot Movement Pattern.

P.C. BOARD LAYOUT



P.C. BOARD LAYOUT



PARTS LIST

Ref. No	Part No	Description	Ref. No	Part No	Description
	RESISTORS			RESISTORS	
R111	R004-331	330 ohm 1/4 Carbon	R211	R004-222	2.2Kohm 1/4W Carbon
R112	R004-331	330 ohm 1/4W Carbon	R212	R004-075	75ohm 1/4W Carbon
R113	R004-331	330 ohm 1/4W Carbon	R213	0010-531	530 ohm 1W Metal Oxide
R114	R004-391	390 ohm 1/4W Carbon	R214	R004-331	330 ohm 1/4W Carbon
R115	R004-391	390 ohm 1/4W Carbon	R215	0010-6N2	6.2 ohm 1/4W Metal Oxide
R116	R004-391	390 ohm 1/4W Carbon	R216	0010-2N7	2.7 ohm 1W Metal Oxide
R117	R004-391	390 ohm 1/4W Carbon	R217	0010-010	10 ohm 1W Metal Oxide
R118	R004-391	390 ohm 1/4W Carbon	R218	0010-272	2.7Kohm 1W Metal Oxide
R119	R004-391	390 ohm 1/4W Carbon	R219	0020-302	3 Kohm 2W Metal Oxide
R120	R004-222	2.2Kohm 1/4W Carbon	R220	R004-331	330 ohm 1/4W Carbon
R121	R004-222	2.2Kohm 1/4W Carbon	R221	0010-102	1 Kohm 1W Metal Oxide
R122	R004-222	2.2Kohm 1/4W Carbon	R223	N150-301	300 ohm 15W Cement
R123	R004-331	330 ohm 1/4W Carbon	R301	R004-102	1 Kohm 1/4W Carbon
R124	R004-561	560 ohm 1/4W Carbon	R302	R004-102	1 Kohm 1/4W Carbon
R125	R004-331	330 ohm 1/4W Carbon	R303	R004-104	100Kohm 1/4W Carbon
R126	R004-561	560 ohm 1/4W Carbon	R304	R004-104	100Kohm 1/4W Carbon
R127	R004-471	470 ohm 1/4W Carbon	R305	R004-102	1 Kohm 1/4W Carbon
R128	R004-561	560 ohm 1/4W Carbon	R306	R004-102	1 Kohm 1/4W Carbon
R131	R004-221	220 ohm 1/4W Carbon	R307	R004-101	100 ohm 1/5 Carbon
R132	R004-221	220 ohm 1/4W Carbon	R308	R004-101	100 ohm 1/4W Carbon
R133	R004-561	560 ohm 1/4W Carbon	R309	R004-473	47Kohm 1/4W Carbon
R134	R004-561	560 ohm 1/4W Carbon	R310	R004-103	10Kohm 1/4W Carbon
R135	R004-331	330 ohm 1/4W Carbon	R311	R004-103	10Kohm 1/4W Carbon
R136	R004-561	560 ohm 1/4W Carbon	R312	R004-103	10Kohm 1/4W Carbon
R137	R002-272	2.7kohm 1/2W Carbon	R313	R004-102	1 Kohm 1/4W Carbon
R138	R002-272	2.7Kohm 1/2W Carbon	R314	R004-151	150ohm 1/4W Carbon
R139	R002-272	2.7Kohm 1/2W Carbon	R315	R004-471	470ohm 1/4W Carbon
R140	R030-472	4.7Kohm 3W Metal Oxide	R316	R004-273	27Kohm 1/4W Carbon
R141	R030-472	4.7Kohm 3W Metal Oxide	R403	R004-474	470Kohm 1/4W Carbon
R142	R030-472	4.7Kohm 3W Metal Oxide	R404	R004-392	3.9Kohm 1/4W Carbon
R150	R004-102	1 Kohm 1/4W Carbon	R405	R004-303	30Kohm 1/4W Carbon
R152	R004-272	2.7Kohm 1/4W Carbon	R406	R004-681	680ohm 1/4W Carbon
R152	R004-272	2.7Kohm 1/4W Carbon	R407	R004-103	10Kohm 1/4W Carbon
R153	R004-272	2.7Kohm 1/4W Carbon	R408	R004-563	56Kohm 1/4W Carbon
R154	R004-122	1.2Kohm 1/4W Carbon	R409	R004-471	470ohm 1/4W Carbon
R155	R004-122	1.2Kohm 1/4W Carbon	R410	R004-681	680Kohm 1/4W Carbon
R156	R004-32	3.9Kohm 1/4W Carbon	R411	R004-472	4.7Kohm 1/4W Carbon
R157	R004-392	3.9Kohm 1/4W Carbon	R412	R004-153	15Kohm 1/4W Carbon
R205	R004-183	18Kohm 1/4W Carbon	R413	R004-472	4.7Kohm 1/4W Carbon
R206	R004-123	12Kohm 1/4W Carbon	R414	R004-622	6.2Kohm 1/4W Carbon
R207	R004-681	680 ohm 1/4W Carbon	R416	R002-272	2.7Kohm 1/2W Carbon
R208	R004-193	10Kohm 1/4W Carbon	R417	R002-022	22ohm 1/2W Carbon
R209	R004-272	2.7Kohm 1/4W Carbon	R418	0010-621	620ohm 1W Metal Oxide
R210	R004-822	8.2Kohm 1/4W Carbon	R419	R002-822	8.2Kohm 1/2W Carbon

PARTS LIST

Ref. No	Part No	Description	Ref. No	Part No	Description
	RESISTORS				
R501	0010-393	39Kohm 1W Metal Oxide	C133	C050-331	330pF 50V Ceramic
R502	0010-3N9	3.9ohm 1W Metal Oxide	C152	C050-821	820pF 50V Ceramic
R503	0010-104	100Kohm 1W Metal Oxide		CAPACITORS	
R504	R004-102	1 Kohm 1/4W Carbon	C201	TA25-225	2.2μF 25V Tantal
R505	0010-010	10ohm 1W Metal Oxide	C202	M050-472	0.0047μF 50V Mylar
R506	0010-101	100ohm 1W Metal Oxide	C203	C050-561	560pF 50V Ceramic
R507	0010-271	270ohm 1W Metal Oxide	C204	C050-681	680pF 50V Ceramic
R508	0020-2N2	2.2ohm 2W Metal Oxide	C205	C050-151	150pF 50V Ceramic
R510	R002-334	330Kohm 1/2W Carbon	C206	M050-333	0.033μF 50V Mylar
R518	0010-472	4.7Kohm 1W Metal Oxide	C207	E050-105	1μF 50V Electrolytic
R601	N050-N47	0.47ohm 5W Cement	C208	E050-106	10μF 50V Electrolytic
R602	0010-331	330ohm 1W Fuse Metal Oxide	C209	E016-227	220μF 50V Electrolytic
R603	0010-680	68ohm 1W Fuse Metal Oxide	C210	E160-106	10μF 160V Electrolytic
R604	R004-105	1Mohm 1/4W Carbon	C211	M500-472	0.0047μF 500V Ceramic
R605	0010-101	100ohm 1/4W Carbon	C212	E160-106	10μF 160V Electrolytic
R606	R004-153	15Kohm 1/4W Carbon	C213	E160-107	100μF 160V Electrolytic
R607	0010-392	3.9Kohm 1/4W Carbon	C301	M050-223	0.022μF 50V Mylar
R608	0010-684	68Kohm 1/4W Carbon	C302	M050-104	0.1μF 50V Mylar
R609	0010-684	68Kohm 1/4W Carbon	C303	E050-105	1μF 50V Electrolytic
R610	N050-010	10ohm 5W Cement	C304	M050-333	0.033μF 50V Mylar
R611	0030-752	7.5Kohm 3W Metal Oxide	C305	C050-921	820pF 50V Ceramic
R612	R004-392	3.9Kohm 1/4W Carbon	C401	E050-105	1μF 50V Electrolytic
R613	R004-683	68Kohm 1/4W Carbon	C402	E050-105	1μF 50V Electrolytic
R614	R004-683	68Kohm 1/4W Carbon	C403	M050-153	0.015μF 50V Mylar
	SEMI-FIXED RESISTOR		C404	M050-473	0.047μF 50V Mylar
R101	F92R-502	5kohm B (Red)	C405	M050-562	0.0056μF 50V Mylar (TIN)
R102	F92G-502	5Kohm B (Green)	C406	M050-682	0.0068μF 50V Mylar
R103	F92B-502	5Kohm B (Blue)	C407	E016-336	33μF 16V Electrolytic
R104	F17W-502	5Kohm B	C408	M050-562	0.0056μF 50V Mylar
R105	F17B-201	200ohm B (Blue)	C409	E050-106	10μF 50V Electrolytic
R106	F17R-201	200ohm B (Red)	C410	C500-561	560pF 500V Ceramic
R107	F17B-502	5Kohm B (Blue)	C411	X162-822	0.0082μF 1600V PP
R108	F17R-502	5Kohm B (Red)	C412	X162-152	0.0015μF 1600V PP
R109	F17G-502	5Kohm B (Green)	C413	X162-152	0.0015μF 1600V PP
R201	F17W-502	5Kohm B	C414	X400-474	0.47μF 200V PP
R202	F17W-201	200ohm B	C415	C500-222	0.0022μF 500V Ceramic
R203	F17W-502	5Kohm B	C501	X200-563	0.056μF 200V PP
R401	F17W-502	5Kohm B	C502	E250-106	10μF 250V Electrolytic
R402	F17W-502	5Kohm B	C503	E050-336	33μF 50V Electrolytic
R415	F92W-502	5Kohm B	C504	E100-335	3.3μF 100V Electrolytic
R420	F17-502	5Kohm B	C505	E025-477	470μF 25V Electrolytic
R612	F92W-202	2Kohm B	C506	C050-103	0.01μF 50V Ceramic
	CAPACITORS		C507	E016-477	470μF 16V Electrolytic
C131	C050-331	330pF 50V Ceramic	C508	C050-103	0.01μF 50V Ceramic
C132	C050-331	330pF 50V Ceramic	C509	E025-477	470μF 25V Electrolytic
			C601	C125-103	0.01μF AC125V Ceramic

PARTS LIST

Ref. No	Part No	Description	Ref. No	Part No	Description
CAPACITORS			D401	D1Z-012	05Z12Y Zener Diode
C602	E200-567	560 μ F 200V Electrolytic	D402	D1Z-012	05Z12Y Zener Diode
C603	C500-472	0.0047pF 500V Ceramic	D403	D1R-002	1N4002 Diode
C604	C500-472	0.0047pF 500V Ceramic	D404	D1F-F02	Ru2 Diode
C605	C500-222	0.0022 μ F 500V Ceramic	D405	D1F-F02	Ru2 Diode
C606	E016-107	100 μ F 16V Electrolytic	SEMICONDUCTORS		
C607	C500-472	0.0047pF 500V Ceramic	D501	D1F-F02	Ru2 Diode
C608	C050-271	270pF 50V Ceramic	D502	D1F-F02	Ru2 Diode
C609	C160-336	33 μ F 160V Electrolytic	D503	D1F-F02	Ru2 Diode
C610	E100-107	100 μ F 160V Electrolytic	D504	D1S-148	1N4148 Diode
C611	E050-476	47 μ F 50V Electrolytic	D505	D1Z-120	12Z Zener Diode
SEMICONDUCTORS			D601	D1R-402	BD4B41 Diode
Q101	S2N-815	2SC1815Y Transistor	D602	D1F-F02	Ru2 Diode
Q102	S2N-815	2SC1815Y Transistor	D603	D1R-402	1SS81 Diode
Q103	S2N-815	2SC1815Y Transistor	D604	D1Z-012	05Z12Y Zener Diode
Q104	S2N-815	2SC1815Y Transistor	D605	D1R-002	1N4002 Diode
Q105	S2N-815	2SC1815Y Transistor	D606	D1Z-012	05Z07Y Zener Diode
Q106	S2N-815	2SC1815Y Transistor	D607	D1Z-120	12Z Zener Diode
Q107	S2N-558	2N6558 Transistor	IC401	IH1-S35	HA11235 IC
Q108	S2N-558	2N6558 Transistor	TRANS FORMERS & COILS		
Q109	S2N-558	2N6558 Transistor	T401	T510-002	Trans former Horiz Drive
Q151	S2N-815	2SC1815Y Transistor	T402	T510-110	Fly back Trans former
Q152	S2N-815	2SC1815Y Transistor	L401	L510-020	Horiz-Width Coil
Q201	S2N-138	2SC1138 Transistor	L402	L510-003	Coil Horiz
Q202	S2N-138	2SC1138 Transistor	L403	L510-002	Coil Horiz Position
Q301	S2N-815	2SC1815Y Trnsistor	L601	L510-100	Coil Line Filter
Q302	S2N-815	2SC1815Y Transistor	MISCELLANEOUS		
Q303	S2N-815	2SC1815Y Transistor	U290-012		CRT Socket
Q401	S2N-558	2N6558 Transistor	F601	U125-004	Fuse 4Amp 125V
Q402	S2N-900	2SD900B Transistor	F602	U125-002	Fuse 2Amp 125V
Q403	S2N-558	2N6558 Transistor	PR601	PR07-207	Posistor
Q601	S2N-042	2SC-2555 Transistor	COLOR PICTURE TUBE		
Q602	S2N-520	2N6520 Transistor	P101	PT01-201	CRT & DY
Q603	S2N-482	2SC2482 Transistor			
Q604	S2N-482	2SC2482 Transistor			
SEMICONDUCTORS					
D150	D1S-148	1N4148 Diode			
D151	D1S-148	1N4148 Diode			
D152	D1Z-012	05Z12/Zener Diode			
D201	D1Z-012	05Z12& Zener Diode			
D202	D1S-148	1N4148 Diode			
D203	D1S-148	1N4148 Diode			
D301	D1S-148	1N4148 Diode			
D302	D1S-148	1N4148 Diode			
D303	D1S-148	1N4148 Diode			
D304	D1S-148	1N4148 Diode			