

# **namco®**

## **TOKYO WARS SD**

### **Operators Manual**

IT IS THE RESPONSIBILITY OF THE OPERATOR TO MAINTAIN CUSTOMER SAFETY  
AT ALL TIMES, AND IT IS IMPERATIVE THAT THE DETAILS SET OUT IN THIS  
MANUAL ARE FOLLOWED PRECISELY.

**NAMCO EUROPE LIMITED**

Namco House, Acton Park Estate,  
The Vale, London W3 7QE, UK

Tel. 0181 324 6000  
Fax. 0181 324 6010

---

**EC Declaration of Conformity**

**Manufacturer:** *As above*

**Details of Electrical Equipment**

**Model Number:** *VI62SD with 28" Hantarex Monitor*

**Model Name:** *Tokyo Wars SD*

**Description:** *Video Arcade Entertainment Machine*

**Serial Numbers:** *36092 ~ 36191, 36889*

**Directives this equipment  
complies with:** *89/336/EEC relating to Electromagnetic Compatibility  
and 73/23/EEC amended by 93/68/EEC relating to  
Low Voltage*

**Harmonised Standards applied:** *BS EN 55014:1993 (Emmissions)  
BS EN 55104:1995 (Immunity)  
IEC 335-1:1991  
IEC 335-2-82:1995 (draft)*

<b>Test Reports issued by:</b>	<b>Notified/Competent Body</b>	<b>Report No</b>
	<i>ERA Technology Ltd</i>	<i>4324/112</i>
	<i>ERA Technology Ltd</i>	<i>97-0266</i>

**Year of Manufacture:** *1997*

**Authorised Signatory:** *M.J. Nevin* **Date of Issue**  
*24th March 1997*

**Name:** *M.J. Nevin*  
**Position:** *Managing Director*

**Place of Issue**  
*London, UK*

## PORTABLE APPLIANCE TESTING

### Please Note:

During testing of the machine with a portable appliance tester the insulation test will show a failure due to the fitting of two VDRs between live / earth and neutral / earth.

These components have been fitted to safeguard against high voltage surges that may occur on the mains supply to the machine and to comply with the EMC regulations.

To conduct an insulation test on this machine, the VDRs must be isolated from the circuit first.

Ensure that the VDRs are reconnected after the insulation test has been completed and before the machine is placed back into service.

The VDRs used have been specified and tested as safety critical components.



No part of this publication may be reproduced by any mechanical, photographic or electronic process, or in the form of phonographic recording, nor may it be stored in a retrieval system, transmitted or otherwise copied for private or public use, without permission from **NAMCO EUROPE LIMITED**.

While the information contained in this manual is given in good faith and was accurate at the time of printing, NAMCO EUROPE LIMITED reserve the right to make changes and alterations without notice.

This machine has been manufactured in accordance with European Community Directives, and has been tested and complies with the Directives 89/336/EEC and 72/23/EEC by the application of EN55014, EN55104 and EN60335-1 standards (see front of manual) and as such bears the CE marking. Any changes or modifications to this machine must be in accordance with the European Directives. Any unauthorised changes to this product, may contravene such Directives.

Under some conditions of extreme external interference, e.g. radio transmissions, electrostatic discharge or mains borne transients, some degradation of performance may occur. However the machine will recover normal performance once the source of the interference has ceased or been removed.

Following abnormally high surges on the mains supply, the video monitor may need to be manually reset by turning the machine OFF and back ON.

Note:-

If the game processor resets due to an interruption or reduction of the mains voltage any credits established may be lost.

This game is not a machine as defined by the Machinery Directive 89/392/EEC

## SAFETY WARNING

In order to use this machine safely, be sure to read this Operators Manual carefully before installation, adjustment or use of this machine.

Whenever the owner of this machine entrusts dis-assembly, installation, adjustment or routine maintenance to another person, the owner should ensure that that person read the appropriate precautions and relevant sections of this manual before starting work.

**In order that no accidents occur when the machine is in operation, strictly follow the notes on safety as described below.**



This manual along with the Installation Manual (where applicable) form an integral part of the equipment and must be available to the operating and service personnel at all times.

This machine is for indoor use only and should only be used for the purpose intended.









Namco Ltd. bears no responsibility for accidents, injury or damage resulting from unauthorized changes to, or improper use of this machine.

## SAFETY NOTES

The following safety notes are used throughout this manual. Familiarize yourself with each of these notes and its meaning before installing, servicing or making adjustments to this machine.

- WARNING**  **Warning denotes a hazard that could result in injury or death. Do not proceed beyond a warning note until the indicated conditions are fully understood and met.**
- CAUTION**  Caution denotes a hazard that could result in damage to the machine. Do not proceed beyond a warning note until the indicated conditions are fully understood and met.

## GENERAL SAFETY CONSIDERATIONS

-  **Only operate this machine after checking that it has been installed correctly and in accordance with the manual.**
-  **If there is an error or problem with the machine, operation must be stopped immediately and the problem rectified before any further use.**
-  **Installation, service, adjustment or routine maintenance should be carried out by suitably qualified persons only.**
-  **For continued protection against fire hazard, replace the mains-in fuses with the same type and rating. The use of other fuses or material is prohibited.**
-  **The power supply inside the monitor will remain hot and have areas of high voltage even though the machine has been turned OFF, and there is the possibility of burns or electric shock. Be careful not to touch these areas.**
-  **To prevent possible electric shock due to failure, this machine **MUST** be fitted with a securely connected EARTHED plug.**
-  **If at any time the mains supply lead becomes damaged, it must be replaced immediately.**
-  **Do not turn the power switch ON until the machine has been installed correctly.**
-  Before connecting the machine to the mains supply, ensure that the machine is set for the correct voltage and that the correct fuses are fitted.

## NOTES ON INSTALLATION

 **NEVER** turn the power to the machine **ON** until installation has been completed.

 In order to prevent possible electric shocks, be sure that the machine is connected to the mains with a securely connected earthed plug.

 In order to avoid damage to the machine due to mis-operation, ensure that the voltage of the mains supply is 230volts AC.

Note: If the location of this machine has a polished floor, it is recommended that rubber pads are fitted under the level adjusters to prevent the machine sliding on the floor.

Note: In order to gain access to the Power Supply and CPU assemblies, make sure that the rear of the machine is separated from a wall or other machine by at least 500mm.

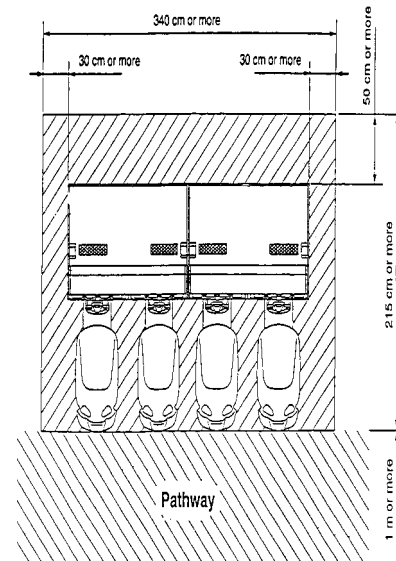

## MOVING THE MACHINE

 This machine is fitted with castors to make it easier to move. Take care when moving the machine on an inclined surface.

 The overall height of the machine, with the Header Assembly fitted, is 2050mm. Take care of any overhead obstructions. (e.g. Light Fittings, Electric Cables etc.)

## REMOVING AND REPLACING PARTS

 Adjustments or maintenance on this machine should be carried out by suitably qualified personnel only.

 Do not make any alteration to this machine without prior approval. Doing so could cause unforeseeable danger.

 Only parts specified by Namco Europe Ltd should be used when replacing or repairing parts. (Including screws).

 Ensure that the power to the machine is turned **OFF** before commencing any maintenance work. (Trouble shooting, repairs etc.)

 If performing work not described in this manual, be sure to contact your distributor for instructions, as no responsibility will be accepted for damage or injury.

 Parts of the Power Supply and Monitor remain hot and carry high voltage even after switching **OFF** and could cause burns or electric shock. Take care not to touch these parts accidentally.

 Make sure that the machine is switched **OFF** before connecting or disconnecting any plugs or connectors.

 When removing the mains connector from the machine, or the mains plug from the wall outlet, always grasp the plug and not the cable.

Dieses Dokument darf in keiner Weise vervielfältigt werden. Jegliche Tonaufnahmen sowie die Speicherung auf Datenträger (Suchsysteme), die Weitergabe oder sonstiges Kopieren für den gewerblichen und privaten Gebrauch sind untersagt und bedürfen der vorherigen Genehmigung durch NAMCO EUROPE LIMITED.

Die Informationen in diesem Handbuch entsprechen den Tatsachen bei Drucklegung. NAMCO EUROPE LIMITED behält sich jedoch das Recht zu Änderungen ohne vorherige Bekanntgabe vor.

Dieses Gerät trägt das CE-Zeichen und wurde gemäß den EU-Richtlinien produziert. Es erfüllt die Richtlinien 89/336/EEC und 72/23/EEC und Standards EN 55014, EN55104 und EN60335-1 (s. Deckblatt des Handbuchs). Alle Veränderungen an diesem Gerät müssen in Übereinstimmung mit den EU-Richtlinien erfolgen. Nicht genehmigte Veränderungen an diesem Gerät verstoßen gegen diese Richtlinien.

Extreme äußere Störungen, wie z.B. durch Radiobetrieb, elektrostatische Entladung oder zeitweilige Netzschwankungen können zu einer Leistungsminderung führen. Sobald diese Faktoren jedoch ausgeschaltet oder beseitigt wurden, erreicht das Gerät seine normale Leistung.

Achtung! Falls der Spielprozessor auf Grund von Netzunterbrechungen oder Abnahme der Netzspannung aussetzt, kann es zum Verlust von Spielkrediten kommen.

Dieses Gerät fällt nicht unter die Maschinen-Richtlinie 89/392/EEC

## SICHERHEITSHINWEISE

Um einen ordnungsgemäßen Betrieb dieses Gerätes zu gewährleisten, muß vor Aufstellung, Inbetriebnahme und Gebrauch das Handbuch sorgfältig gelesen werden.

Sobald der Besitzer dieses Gerätes die Demontage, Aufstellung, Inbetriebnahme oder den Service einer anderen Person überträgt, muß er sicherstellen, daß diese Person vor Arbeitsbeginn die nötigen Sicherheitshinweise und die dazugehörigen Kapitel des Handbuchs liest und versteht.

Um jegliche Unfälle während des Betriebes zu vermeiden, müssen obige Hinweise strikt befolgt werden.

Dieses Handbuch sowie das spezielle Geräte-Handbuch (wenn vorhanden) gehören zum Gerät und müssen dem Betreiber und Wartungspersonal stets zugänglich sein.

Dieses Gerät ist ausschließlich für den gewerblichen Gebrauch in geschlossenen Räumen bestimmt und darf nur dort betrieben werden.

NAMCO LTD. übernimmt keinerlei Haftung für Unfälle, Verletzungen oder Beschädigungen, die auf nicht genehmigte Veränderungen oder unsachgemäßen Betrieb des Gerätes zurückzuführen sind.









## SICHERHEITSHINWEISE

Folgende Sicherheitsbegriffe werden im gesamten Handbuch benutzt. Machen Sie sich daher bitte vor Inbetriebnahme, Wartung und Durchführung von Einstellungen am Gerät mit diesen Warnhinweisen vertraut.

**WARNUNG**  **WARNUNG bezeichnet eine Gefahrenquelle für Leib und Leben. Erscheint dieser Warnhinweis, darf erst weitergearbeitet werden, wenn die entsprechenden Erklärungen vollständig verstanden und befolgt wurden.**

**VORSICHT**  **VORSICHT bezeichnet eine Gefahrenquelle für die Beschädigung des Gerätes. Erscheint dieser Warnhinweis, darf erst weitergearbeitet werden, wenn die entsprechenden Erklärungen vollständig**

## ALLGEMEINE SICHERHEITSHINWEISE

-  **Das Gerät darf nur betrieben werden, nachdem es vorschriftsmäßig und in Übereinstimmung mit dem Handbuch aufgestellt wurde.**
-  **Bei Auftreten eines Fehlers oder Problems muß das Gerät sofort abgeschaltet werden und darf erst nach fachgerechter Behebung des Fehlers wieder in Betrieb genommen werden.**
-  **Aufstellung, Service, Einstellungen und Wartung dürfen nur von dafür qualifiziertem Fachpersonal durchgeführt werden.**
-  **Zur Vermeidung von Feuer, defekte Sicherungen nur durch vorgeschriebene Sicherungen ersetzen. Die Verwendung von andersartigen Sicherungen oder unterschiedlichem Material ist untersagt.**
-  **Das Netzteil im Monitor bleibt nach Ausschalten des Gerätes noch heiß und führt weiterhin Hochspannung. Daher besteht die Gefahr von Verbrennungen und Elektroschlägen. Diese Bereiche dürfen nicht berührt werden.**
-  **Zur Vermeidung von Elektroschlägen muß dieses Gerät mit einem ordnungsgemäß geerdeten Netzstecker versehen sein.**
-  **Bei Beschädigungen des Netzteiles muß dieses umgehend ersetzt werden.**
-  **Gerät erst nach abgeschlossener Aufstellung einschalten.**
-  **Vor Einstecken des Netzsteckers bitte sicherstellen, daß Netzspannung und Gerätespannung übereinstimmen, und die vorgeschriebenen Sicherungen verwendet wurden.**

## HINWEISE ZUR AUFSTELLUNG

- ⚠ NIEMALS das Gerät einschalten bevor die Aufstellung völlig abgeschlossen ist.
- ⚠ Zur Vermeidung von Elektroschlägen muß das Gerät mit einem ordnungsgemäß geerdetem Netzstecker an die Stromversorgung angeschlossen werden.
- ⚠ Zur Vermeidung von Beschädigungen durch Fehlbetrieb am Gerät sicherstellen, daß die Netzspannung 230 Volt beträgt.

Hinweis: Ist das Gerät für einen Aufstellplatz mit glattem Fußboden bestimmt, müssen die Standbeine mit Gummiplättchen unterlegt werden, damit das Gerät fest steht und nicht auf dem Boden hin- und herrutscht.

Hinweis: Zu Reparaturzwecken am Netzteil und den CPU-Komponenten muß die Rückseite des Gerätes mindestens 50cm von anderen Geräten und der Wand entfernt sein.

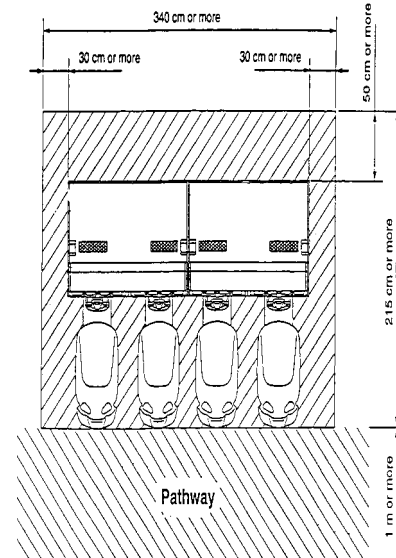

- ⚠ **Zum leichteren Transport ist das Gerät mit Rollen ausgerüstet. Daher besondere Vorsicht auf abschüssigem Boden.**
- ⚠ **Die Gesamthöhe de Gerätes beträgt 2050mm. Daher Vorsicht bei tiefer hängenden Beleuchtungskörpern.**

Einstellung und Wartung des Gerätes dürfen nur von qualifiziertem Fachpersonal vorgenommen werden.

Aucun élément de cette publication ne sera reproduit, ni par procédé mécanique, photographique ou électronique, ni par un moyen d'enregistrement phonographique. Ces informations ne seront ni stockées grâce à un procédé de récupération, ni transmises ou autrement copiées pour un usage public ou privé, sans l'autorisation de **NAMCO EUROPE LIMITED**.

Malgré le fait que les informations contenues dans ce manuel soient données de bonne foi et étaient actualisées au moment de leur impression, NAMCO EUROPE LIMITED se réserve le droit de procéder à des changements ou à des modifications sans avis préliminaire.

Ce jeu a été fabriqué en respect des normes de la Communauté Européenne, après avoir été testé il répond aux normes 89/336/EEC et 72/23/EEC, en application des standards EN55014, EN55104 et EN60335-1 (voir la couverture du manuel), et comme tel il comporte l'autocollant de conformité avec les normes de la Communauté Européenne. Tout changement non autorisé sur ce produit pourrait contrevenir à ces normes.

Sous certaines conditions extrêmes d'interférence externe, par exemple des transmissions radio, des décharges électrostatiques ou bien de interférences passagères sur le réseau, certaines dégradations ou anomalies peuvent se produire. Le jeu retrouvera cependant son état normal de fonctionnement lorsque la cause de ces anomalies aura cessé ou se trouvera déplacée.

Note:-

Si le processeur du jeu se reprogramme suite à une interruption ou une réduction de l'alimentation, les crédits qu'il aurait pu contenir peuvent se trouver perdus.

Ce jeu n'est pas une machine, telle que définie par la norme sur les machines 89/392/EEC

## MESURES DE SECURITE

Afin d'utiliser ce jeu en toute sécurité, bien lire ce manuel d'utilisation avant de procéder à son installation, son réglage ou son exploitation.

Si le propriétaire de ce jeu en confie la démontage, l'installation, le réglage ou la maintenance habituelle à une autre personne, il devra s'assurer que cette personne ait lu les conseils d'utilisation et les passages du manuel se rapportant à ce thème, avant qu'elle ne commence son travail.

Afin d'éviter tout accident pendant la durée d'exploitation de ce jeu, se conformer strictment aux conseils de sécurité décrits à la suite.

Ce manuel ainsi que le manuel d'installation du jeu (là où nécessaire) font partie des éléments nécessaires à l'installation de la machine et doivent être mis à la disposition de l'utilisateur et du personnel de maintenance à tout moment.

Ce jeu est uniquement destiné à un usage intérieur et devra être utilisé comme tel.

Namco Ltd. ne sera aucunement tenu responsable en cas d'accidents, de blessure ou de dommage quelconque résultant de modifications non autorisées ou d'usage impropre du jeu.









### REMARQUES SUR LA SECURITE

Les termes de sécurité détaillés à la suite seront utilisés tout au long de la lecture de ce manuel. Il convient de vous familiariser avec chacun de ces termes ainsi que leur signification avant de procéder à l'installation, à la maintenance ou au réglage du jeu.

**AVERTISSEMENT**  Ce terme annonce un danger qui pourrait éventuellement avoir des conséquences dommageables ou mortelles. Ne pas passer outre ce signal jusqu'à ce que les conditions indiquées soient entièrement comprises et effectuées.

**ATTENTION**  Ce terme indique qu'un danger menace la machine. Ne pas passer outre ce signal jusqu'à ce que les conditions indiquées soient entièrement comprises et effectuées.

### CONSIGNES GENERALES DE SECURITE

-  **Allumer l'appareil seulement après avoir vérifié qu'il a été correctement installé, et que les instructions du manuel ont été respectées.**
-  **S'il y a une erreur ou un problème avec la machine, l'utilisation doit être immédiatement interrompue et le problème résolu avant toute nouvelle utilisation.**
-  **L'installation, le service, le réglage, ou la maintenance doivent être effectués uniquement par les personnes qualifiées.**
-  **Afin d'éviter un éventuel incendie, s'assurer que les fusibles soient remplacés par le même type de fusibles et au bon voltage. L'utilisation d'autres sortes de fusibles ou autres matériels est interdite.**
-  **L'alimentation à l'intérieur du moniteur reste chaude et comporte des zones de haute tension même si la machine est éteinte. Il existe donc un risque de brûlure ou d'électrocution. Attention à ne pas toucher ces endroits.**
-  **Pour prévenir une éventuelle électrocution due à un défaut matériel, ce jeu DOIT être muni d'une prise de TERRE connectée en toute sécurité**
-  **Si à tout moment les fils électriques sont endommagés, il faut les remplacer immédiatement**
-  **Ne pas mettre le jeu en mode de fonctionnement avant qu'il n'ait été correctement installé.**
-  Avant de connecter la machine au réseau, s'assurer que la machine est installée sous la bonne tension et que les fusibles correspondent.



## NOTES D'INSTALLATION

- ⚠ NE JAMAIS mettre le jeu en marche avant que l'installation ne soit complètement effectuée.
- ⚠ Afin de prévenir une éventuelle électrocution, s'assurer que la machine est connectée au réseau avec une prise de terre reliée selon les normes de sécurité.
- ⚠ Afin d'éviter que la machine ne soit abîmée suite à une mauvaise opération, s'assurer que la tension sur le réseau principal soit de 230 volts AC.

Note: Si l'endroit où doit être installée la machine à un sol poli, il est recommandé de poser des tampons feutrés sous les vérins pour éviter que le jeu ne glisse sur le sol

Note: Afin de faciliter l'accès aux CPU et à l'alimentation, s'assurer qu'il y a un espace d'au moins 500 mm entre l'arrière du meuble et le mur ou tout autre jeu.

50cm von anderen Geräten und der Wand entfernt sein.

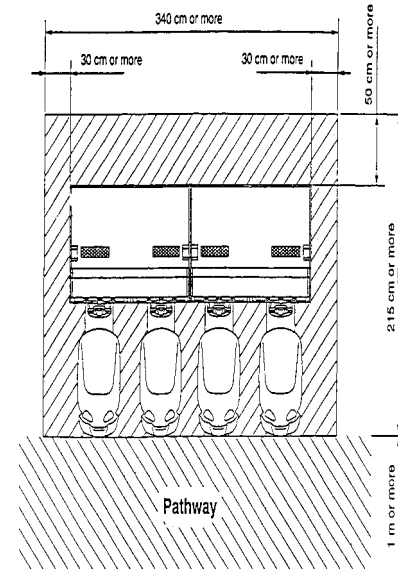

- ⚠ **Le jeu est fourni avec des roulettes pour une meilleure mobilité. Prendre garde quand la machine est déplacée sur une surface inclinée.**
- ⚠ **Le centre de gravité de la partie supérieure du jeu est situé sur l'avant, il est donc indispensable que deux personnes au moins soient employées pour installer ou déplacer la partie supérieure.**
- ⚠ **La hauteur totale de l'assemblage principal est de 2050 mm, prendre garde aux encombrements de la partie supérieure (ex : illuminations du bandeau).**

## DEPLACER ET REMPLACER LES UNITES ET LES PIECES DETACHEES.

- ⚠ **L'installation, le service, le réglage, ou la maintenance doivent être effectués uniquement par les personnes qualifiées.**
- ⚠ Ne pas apporter de modifications sur cette machine sans autorisation préalable, faute de quoi cela pourrait entraîner un danger.
- ⚠ Seules les pièces détachées Namco Europe Ltd. doivent être utilisées pour le remplacement ou la réparation de pièces (y compris les vis)
- ⚠ S'assurer que l'interrupteur soit sur OFF avant de commencer tout travail de maintenance (localisation d'une panne, réparations, etc.)
- ⚠ Si dans ce manuel il manque une information pour réaliser un quelconque travail, contacter votre distributeur, car aucune responsabilité ne sera acceptée en cas de dommage ou de blessure.
- ⚠ Les pièces de l'alimentation et du moniteur restent chaudes, à tension élevée même lorsque la machine est hors tension, elle pourrait occasionner des brûlures ou des électrocutions. Attention de ne pas toucher ces endroits accidentellement.
- ⚠ S'assurer que la machine soit hors tension avant de brancher ou débrancher toute prise ou connecteur.
- ⚠ Lorsque l'on manipule la prise au réseau de la machine, ou lorsque les prises principales doivent être débranchées, saisir toujours la prise, et non le câble.



Nessuna parte di questa pubblicazione può essere riprodotta con processo meccanico, fotografico o elettronico, nè sotto forma di registrazione fonografica, nè può essere memorizzata in un sistema di salvataggio, trasmessa o in altro modo copiata per uso pubblico o privato, senza l'autorizzazione di **NAMCO EUROPE LIMITED**.

Le informazioni contenute in questo manuale sono state date in buona fede ed erano accurate al momento della pubblicazione. Tuttavia NAMCO EUROPE LIMITED, si riserva il diritto di apporre cambiamenti e variazioni senza alcun preavviso.

Questo apparecchio è stato costruito in conformità alle Direttive della Comunità Europea, ed è stato provato e soddisfa le Direttive 89/336/EEC e 72/23/EEC per l'applicazione degli standards delle norme EN55014, EN55104 e EN60335-1 (vedi fronte del manuale), e per questo porta il marchio CE. Qualsiasi cambiamento o modifica di questo apparecchio deve essere in conformità con le Direttive della Comunità Europea.

In caso di condizioni di estrema interferenza dall'esterno, per esempio trasmissioni radio, scariche elettrostatiche o transistori sulla linea, può verificarsi un decadimento delle prestazioni. Comunque l'apparecchio ritornerà al rendimento normale quando la sorgente dell'interferenza avrà cessato di emettere o sarà stata rimossa.

Nota bene: se il processore del gioco "resetta" a causa di una interruzione o diminuzione del voltaggio di linea, un eventuale credito, già concesso, può essere annullato.

Questo gioco non è una macchina così come viene definita dalla Direttiva Macchine 89/392/EEC.

## AVVERTENZE PER LA SICUREZZA

Allo scopo di usare questo apparecchio in sicurezza, leggere questo Manuale dell'operatore attentamente prima dell'installazione, regolazione o uso di questa macchina.

Tutte le volte che il proprietario di questo apparecchio affida lo smontaggio, l'installazione, la regolazione o la manutenzione ordinaria ad un'altra persona, il proprietario stesso deve assicurarsi che quella persona legga le precauzioni necessarie e i paragrafi importanti di questo manuale prima di iniziare a lavorare.

**Perchè non succeda alcun incidente quando la macchina è operante, seguire rigorosamente le note sulla sicurezza come specificato più avanti.**

Questo manuale insieme con il manuale di installazione (dove si può applicare) forma una parte integrante dell'apparecchio e deve essere disponibile sempre al personale operante e di servizio.

Questa macchina deve essere usata solo in interni e deve essere usata solo per gli scopi per cui è progettata.

Namco Europe Ltd non si assume responsabilità per incidenti, ferite o danni risultanti da cambiamenti non autorizzati o da uso improprio della macchina.









## NOTE PER LA SICUREZZA

Le seguenti note sulla sicurezza sono usate dal principio alla fine di questo manuale. Valutare attentamente ciascuna di queste note ed il loro significato prima di installare, fare assistenza o regolazioni su questa macchina.

**WARNING**  "Warning" evidenzia un rischio di ferita o di morte. Non procedere oltre una nota "Warning" finchè le avvertenze specificate non siano completamente capite e conosciute.

**CAUTION**  "Caution" evidenzia un rischio di danneggiare la macchina. Non procedere oltre una nota "Caution" finchè le avvertenze specificate non siano completamente capite e conosciute.

## CONSIDERAZIONI GENERALI SULLA SICUREZZA

-  **Mettere in funzione l'apparecchio solo dopo aver controllato che l'installazione sia stata effettuata correttamente ed in conformità alle istruzioni del manuale.**
-  **Se vi sono errori o problemi con la macchina, si deve interrompere il funzionamento immediatamente e risolvere il problema prima di ogni ulteriore uso.**
-  **L'installazione, l'assistenza, le regolazioni e la manutenzione ordinaria devono essere eseguite solo da persone idonee e qualificate.**
-  **Per una protezione costante contro il rischio di fuoco, assicurarsi che i fusibili sulle alimentazioni siano solo sostituiti con lo stesso tipo e caratteristiche. L'uso di altri fusibili o materiali è proibito.**
-  **L'alimentatore all'interno del monitor rimane caldo ed ha zone di alto voltaggio anche se la macchina è stata spenta, c'è quindi la possibilità di bruciate o scosse elettriche. Fare attenzione a non toccare queste zone.**
-  **Per prevenire possibili scosse elettriche dovute a difetti, questa macchina DEVE essere installata con un connettore sicuramente MESSO A TERRA.**
-  **In caso il cavo di alimentazione di rete risultasse danneggiato deve essere sostituito immediatamente.**
-  **Non accendere la macchina finchè la stessa non è stata installata completamente e correttamente.**
-  Prima di collegare la macchina alla rete, assicurarsi che la macchina sia preparata per il voltaggio corretto e che siano inseriti i fusibili adatti.

## NOTES D'INSTALLATION

- ⚠ **NON ACCENDERE MAI la macchina finchè l'installazione non è stata completata.**
- ⚠ Allo scopo di prevenire possibili scosse elettriche, la macchina deve essere obbligatoriamente collegata alla rete con un connettore messo a terra con connessioni sicure.
- ⚠ Per evitare danni alla macchina durante la messa in opera, assicurarsi che il voltaggio della rete sia 230 volts AC.

Note: Il luogo di destinazione della macchina deve avere il pavimento liscio e si raccomanda di sistemare dei cuscinetti di gomma sotto i piedini di livellamento per prevenire lo scivolamento della macchina sul pavimento.

Note: Per garantire l'accesso all'alimentatore e alla scheda madre, assicurarsi che il retro del mobile principale sia separato dalla parete o da altre macchine di almeno 500mm. meuble et le mur ou tout autre jeu.

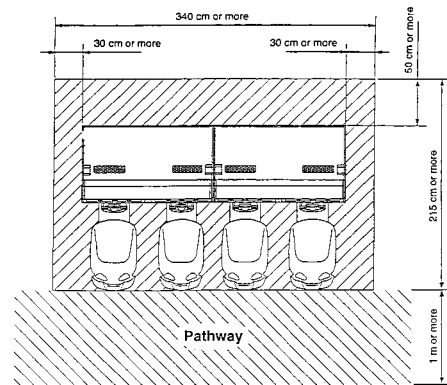

- ⚠ **Il gioco è fornito di ruote per rendere più facile il suo spostamento. Fare attenzione quando si muove la macchina su una superficie inclinata.**
- ⚠ **L'altezza totale della parte principale è 2050mm, fare attenzione ad eventuali ostacoli sopra la testata ovvero ad eventuali installazioni di luci.**

## RIMOZIONE E SOSTITUZIONE DI GRUPPI E PARTI STACCATE

- ⚠ **L'installazione, l'assistenza, le regolazioni e la manutenzione ordinaria essere eseguite solo da persone idonee e qualificate.**
- ⚠ **Non apporre alcuna modifica alla macchina senza autorizzazione preventiva. Il fare questo può causare un pericolo non prevedibile.**
- ⚠ **Quando si rimpiazza o si riparano delle parti ( incluse le viti) si possono usare solo parti approvate dalla Namco Europt Ltd.**
- ⚠ **Assicurarsi che la macchina sia SPENTA prima di incominciare qualsiasi lavoro di manutenzione (guasti, riparazioni etc.)**
- ⚠ **Se state per iniziare un lavoro non descritto in questo manuale, contattate il vostro distributore per istruzioni pochè non si accetta alcuna responsabilità per danni o ferite.**
- ⚠ **Parti dell'alimentatore e del monitor rimangono caldi o portano alta tensione anche dopo aver spento l'apparecchiatura e possono causare bruciateure o scosse elettriche. Attenzione a non toccare queste parti accidentalmente.**
- ⚠ **Assicurarsi che la macchina abbia l'interruttore nella posizione OFF prima di inserire o disinserire qualsiasi connettore o spina.**
- ⚠ **Quando vengono rimossi i connettori principali dalla macchina oppure la spina dell'alimentazione dalla parete bisogna sempre afferrare il connettore e non il cavo**

Tästä julkaisusta ei saa ottaa missään muodossa kopioita yksityis- tai julkiseen käyttöön ilman **NAMCO EUROPE LIMITED**:in lupaa.

Tässä ohjekirjassa olevat tiedot pitävät julkaisuhetkellä paikkansa. NAMCO EUROPE LIMITED:illä on kuitenkin oikeus muutoksiin ilman erillistä ilmoitusta.

Tämä laite on valmistettu EC direktiivien mukaisesti. Se on testattu ja todettu noudattavan seuraavia direktiivejä: 89/336/EEC ja 72/23/EEC (EN55014, EN55104 ja EN 60335-1 standardit). Näin ollen tämä laite on varustettu CE-merkinnällä. Kaikki tähän laitteeseen kohdistetut muutokset on tehtävä EC- direktiivien mukaisesti. Mikä tahansa valtuuttamattoman huoltomiehen tekemä muutos voi olla direktiivien vastainen.

Laitteen toiminta voi häiriintyä määrättyissä olosuhteissa, jotka johtuvat äärimmäisistä ulkoisista sähköhäiriöistä, kuten radiolähetykset, elektrostaattinen purkaus tai vahvavirrasta syntynyt häiriö. Toiminta normalisoituu kuitenkin heti, kun ulkoinen sähköhäiriö on poistettu.

Huom.- Jos peliprosessori resetoituu sähkökatkoksen tai vastaavan johdosta, voivat kaikki pelivaraukset hävitä.

Tämä laite ei ole 89/392/EEC direktiivien mukainen kone.

## Turvallisuusvaroitukset

Tämän laitteen turvallinen käyttö edellyttää käyttöohjekirjan huolellista lukemista ennen laitteen asennusta, säätöä tai käyttöä.

Jos tämän laitteen omistaja antaa jollekin toiselle osapuolelle tehtäväksi purkaa, asentaa, säätää tai muuten huoltaa laitetta, on omistajan varmistettava siitä, että toinen osapuoli on lukenut ja ymmärtänyt käyttöohjekirjan oleelliset osat ennen työhön ryhtymistä.

**Turvallisuusohjeita on seurattava tarkoin vahinkojen välttämiseksi laitteen ollessa käytössä .**

Tämä ohje sekä mahdollinen asennusohje muodostavat laitteiston oleellisen osan ja on siksi aina oltava huolto- ja käyttöhenkilökunnan käytettävissä.

Tämä laite on tarkoitettu vain sisätiläkäyttöön. Sitä ei saa käyttää muihin tarkoituksiin.

Namco Ltd ei vastaa niistä onnettomuuksista, loukaantumisista tai vahingoista, jotka johtuvat laitteeseen ilman Namco Ltd:n lupaa tehdyistä muutoksista laitteen vääristä käytöstä.









## Turvallisuusohjeet

Tässä käyttöohjekirjassa on käytetty seuraavia turvallisuuteen liittyviä huomautuksia. Tutustu jokaiseen näistä. Älä asenna, huolla tai säädä laitteistoa, ennen kuin olet täysin ymmärtänyt mitä ne tarkoittavat.

**VAARA**  "Vaara" tarkoittaa uhkaa, joka voi johtaa loukkantumiseen tai kuolemaan, Älä koskaan ohita Vaara-merkintää, ennen kuin ohjeissa esitetyt olosuhteet on ymmärretty täysin.

**VAROITUS**  "Varoitus" tarkoittaa uhkaa, joka voi johtaa laitteen vioittumiseen. Älä koskaan ohita Vaara-merkintää, ennen kuin ohjeissa esitetyt olosuhteet on ymmärretty täysin.

## YLEISET TURVALLISUUSNÄKÖKOHDAT

-  **Varmista, että laite on asennettu oikein ja ohjekirjan mukaisesti ennen käyttöönottoa.**
-  **Jos laitteeseen tulee vika tai ongelmia, on se pysäytettävä välittömästi ja ongelma selvitettävä ennen uutta käyttöönottoa.**
-  **Vain riittävän ammattipätevyyden omaava henkilö saa suorittaa asennus-, huolto-, säätö- tai muita laitteeseen kohdistuvia rutiinitoimenpiteitä.**
-  **Jotta palovaaraa ei syntyisi, saa pääsulakkeita vaihtaa vain samankokoisiin sulakkeisiin. Muiden sulakkeiden tai materiaalin käyttö on ehdottomasti kielletty.**
-  **Monitorin sisällä oleva virtalähde pysyy kuumana ja siinä on alueita, joissa on korkea jännite vaikka laite on kytketty pois päältä. Palovammojen tai sähköiskun saaminen on mahdollista. Älä koske näihin alueisiin.**
-  **Sähköiskujen välttämiseksi vikatapauksissa, laite on ehdottomasti kytkettävä maadoitetulla johdolla maadoitettuun pistorasiaan.**
-  **Vioittunut verkkojohto on välittömästi vaihdettava.**
-  **Älä kytke laitetta päälle, ennen kuin se on oikein asennettu.**
-  **Varmista ennen verkkoon kytkemistä, että virtalähteen jännitteen asetus on asetettu oikealle jännitteelle ja että siinä on oikeat sulakkeet.**

## ASENNUSHUOMIOITA



Älä koskaan kytke laitetta päälle ennen kuin asennus on suoritettu loppuun.



Tämän laitteen virtalähde on kytkettävä maadoitetulla johdolla maadoitettuun pistorasiaan, jotta sähköiskun vaaraa ei olisi.



Varmista, että virtalähteen jännite on 230V AC, jotta ei laite vioitu.

Huomio: Jos tämä laite sijoitetaan liukkaalle esim. vahatulle lattialle, suositellaan laitettavaksi kumityynyä säätöjalkoihin liikkumisen estämiseksi.

Huomio: Varmista, että takaosan taakse jää vähintään 500mm tilaa, jotta virtalähteeseen ja CPU-korttiin pääsee käsiksi.

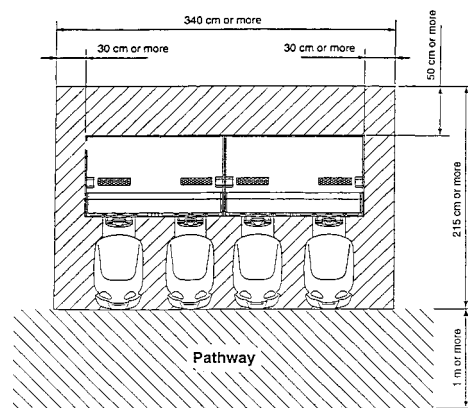

Laite on varustettu kääntyvillä pyörillä. Tämä on pidettävä mielessä, kun laitetta siirretään kaltevalla alustalla.



Laitteen kokonaiskorkeus on yli 2300 mm. Varmista, ettei katossa ole esteitä. esim. valaisimia.

## OSIEN JA OSAKOKONAISUUKSIEN POISTO JA VAIHTO



Vain riittävän ammattipätevyyden omaava henkilö saa suorittaa asennus-, huolto-, säätö- tai muita laitteeseen kohdistuvia rutiinotoimenpiteitä.



Tälle laitteelle ei saa tehdä mitään hyväksymättömiä muutoksia. Se voi aiheuttaa ennalta-arvaamattomia vaaroja.



Vain Namco Europe Ltd:n määrittelemiä varaosia saa häyttää vaihtaessasi tai korjatessasi osia. (sisältäen ruuvit).



Varmista, että laite on kytketty POIS PÄÄLTÄ ennen työn aloittamista.



Ota yhteyttä maahantuojaan ohjeita varten, jos joudut tekemään työtehtäviä, joita ei ole esitelty huoltokirjassa, muuten vastuuta vioista tai loukkaantumisista ei ole.



Virtalähde ja monitori pysyvät kuumina ja niissä on alueita, joissa on korkeajännite vaikka laite on kytketty pois päältä. Palovammojen tai sähköiskun saaminen on mahdollista. Älä koske näihin laitteisiin.



Varmista, että laite on kytketty POIS PÄÄLTÄ ennen johtojen kytkemistä tai irrottamista.



Irrottaessasi verkkojohdon seinästä, ota kiinni itse pistokkeesta, ei johdosta.

# Contents

CERTIFICATE OF CONFORMITY .....	2
PORTABLE APPLIANCE TESTING.....	3
SAFETY WARNING .....	4
NOTES ON INSTALLATION .....	4
MOVING THE MACHINE .....	5
REMOVING AND REPLACING PARTS .....	5
ALLGEMEINE SICHERHEITSHINWEISE .....	6
CONSIGNES GENERALES DE SECURITE.....	8
CONSIDERAZIONI GENERALI SULLA SICUREZZA.....	10
YLEISET TURVALLISUUSNÄKÖKOHDAT .....	12
1. SPECIFICATIONS .....	15
2. HOW TO PLAY.....	16
3. MAJOR COMPONENTS .....	17
4. MOVING THE MACHINE .....	18
5. INSTALLATION.....	18
6. ADJUSTMENTS .....	21
6-3 Test Mode.....	22
6-3-1 Coin Options .....	23
6-3-2 Game Options .....	24
6-3-3 Effect Test .....	25
6-3-4 Switch Test.....	26
6-3-5 Monitor Test .....	27
6-3-6 Sound Test.....	27
6-3-7 Displaying and Resetting the Game Data .....	28
6-3-8 Displaying the Archive Data .....	28
6-4 Initialization after Replacing Parts .....	29
6-5 Self Test .....	29
6-6 Linking Two Machines .....	30
6-6-1 Setting the Link Switches .....	30
7. MAINTENANCE .....	31
7-1 Replacing the Fluorescent Tube, Starter and Lamps .....	32
7-2 Replacing the Viewpoint and Credit Available Switches.....	33
7-3 Removing the Steering Wheel .....	33
7-4 Replacing the Trigger Button.....	33
7-5 Replacing the Steering Potentiometer.....	33
7-6 Removing the Pedal Assembly .....	34
7-7 Replacing the Pedal Potentiometer .....	34
8. PARTS .....	35
9. SCHEMATIC.....	38

# 1. SPECIFICATIONS

**POWER SUPPLY:-** 230volts AC

**AMBIENT OPERATING TEMPERATURE:-**

+5°C to +25°C

**MONITOR:-** Hantarex 28" Polo Monitor

**COIN ACCEPTOR:-** Mars CashFlow - Dispense

**DIMENSIONS:-**

Assembled 1400(w) x 1650(d) x 2050(h)

Cabinet 1400(w) x 930(d) x 2050(h)

Seat Assy 490(w) x 820(d) x 1330(h)

**WEIGHT:-**

Assembled 345kg

Cabinet 295kg

Seat Assy 25kg

**ACCESSORIES:-**

Keys: (Cash Door)..... 2  
(Coin Door)..... 2  
(Back Door) ..... 2ea

IEC Mains Lead ..... 1

Operators Manual ..... 1

Monitor Manual ..... 1

CashFlow Documents ..... 1

Link Cable 4m ..... 1

M4 Security Wrench ..... 1

M5 Security Wrench ..... 1

M6 Security Wrench ..... 1

## 2. HOW TO PLAY

This game is a multi-player fighting game where one or two players join two armies to fight against the opposing army. By using the steering wheel and accelerator pedals, a player controls their tank and moves freely in the city limits in order to search out and attack the enemy.

### OPERATION

- 1) Stepping on the forward pedal (right pedal): Player's tank moves forward.
- 2) Stepping on the backward pedal (left pedal): Player's tank moves backwards.
- 3) Turning the steering wheel: Players gun barrel and tank turn in the direction that the wheel has been turned.
- 4) Pushing the trigger button (left or right): Players tank fires a shot.
- 5) Pushing the Viewpoint Button: Possible to switch between the third person view or the first persons view.

### GAME RULES

- 1) The player joins either the green army or white army and tries to destroy the enemy.
- 2) When a player destroys an enemy tank, a shield restoration item appears. If it is touched and obtained, a certain amount of damage to the players tank is restored.
- 3) Even if a player's or computer's tank is destroyed, they can continue playing whilst there are remaining tanks in their army.
- 4) The game is over when either army has been totally destroyed, or the game time reaches zero.

### STAGE

The stage can be selected from two options. One is the small bay area with a simple shape. The other is the large centre of a city with a complicated shape.

### BACKGROUND MUSIC

- 1) The player who has inserted coins first can select the BGM played during the game.
- 2) Before the game starts, the sound title is displayed while the enemy / allies are being displayed. The tune can be changed by pressing either trigger button.



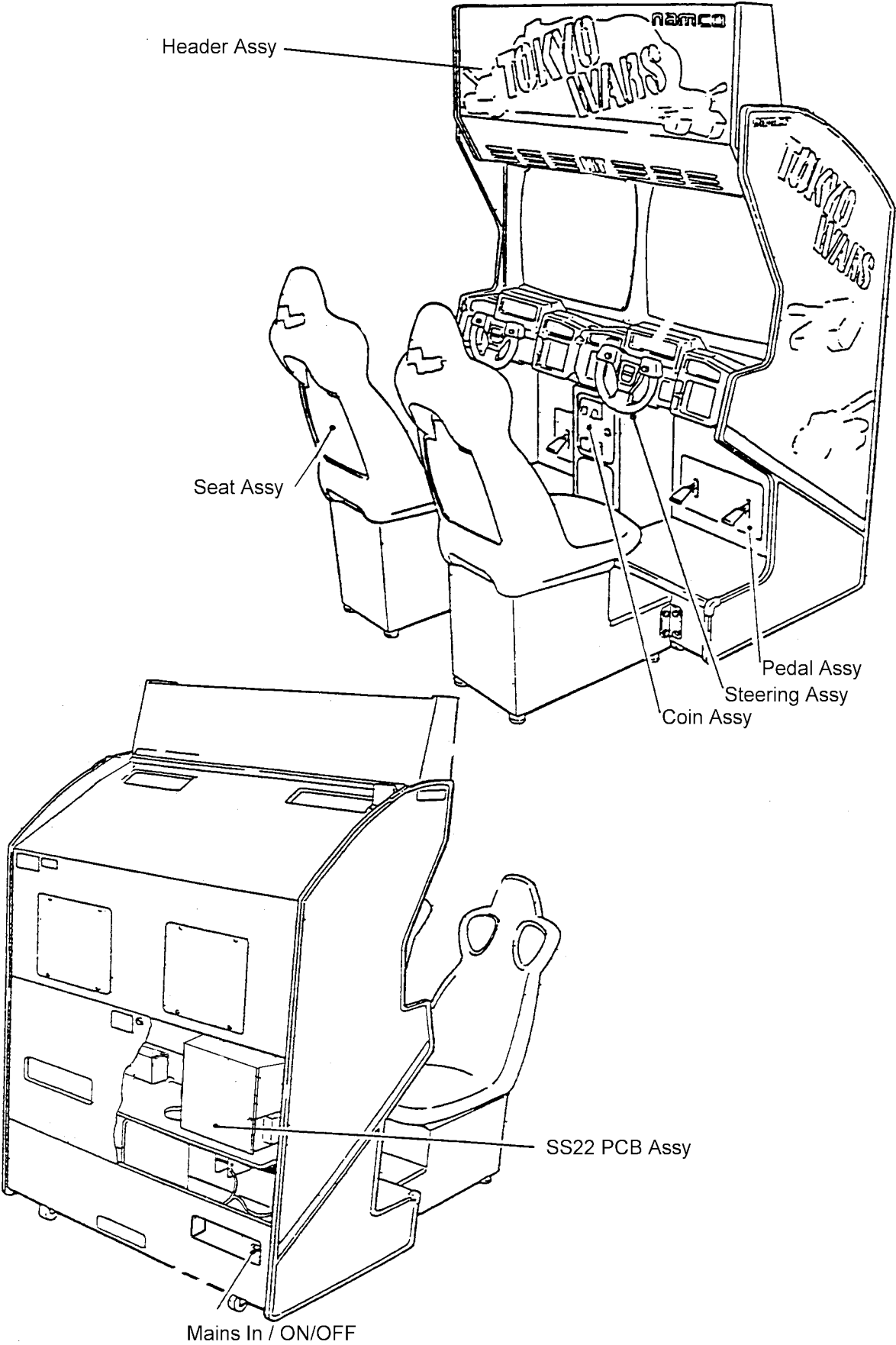

3. MAJOR COMPONENTS





## 4. MOVING THE MACHINE

### MOVING THE MACHINE

-  This machine is fitted with castors to make it easier to move. Take care when moving the machine on an inclined surface.
-  The overall height of the machine, with the Header Assembly fitted, is 2050mm. Take care of any overhead obstructions. (e.g. Light Fittings, Electric Cables etc.)

## 5. INSTALLATION

### NOTES ON INSTALLATION

-  **NEVER** turn the power to the machine ON until installation has been completed.
-  In order to prevent possible electric shocks, be sure that the machine is connected to the mains with a securely connected earthed plug.
-  In order to avoid damage to the machine due to mis-operation, ensure that the voltage of the mains supply is 230volts AC.

Note: If the location of this machine has a polished floor, it is recommended that rubber pads are fitted under the level adjusters to prevent the machine sliding on the floor.

Note: In order to gain access to the Power Supply and CPU assemblies, make sure that the rear of the machine is separated from a wall or other machine by at least 500mm



This machine is designed for **INDOOR USE ONLY**.  
**Do not** install in the following places.

1. Outdoors
2. Direct Sunlight, places with excessive humidity or dust, places where there is water leakage, near air-conditioning or heating equipment, places with excessive heat or cold temperature.
3. Places where it would be in the way of emergency exits or fire extinguishing equipment.
4. Unstable places or places with excessive vibration.
5. Places that are not level.



**D** DIESES GERÄT IST NUR FÜR DIE GEWERBLICHE AUFSTELLUNG IN GESCHLOSSENEN RÄUMEN BESTIMMT. DAS GERÄT DARF AN FOLGENDEN PLÄTZEN NICHT AUFGESTELLT WERDEN

1. Im Freien.
2. In direktem Sonnenschein, an extrem feuchten und staubigen Plätzen, an Plätzen mit Wasseranschlüssen und möglichen Leckagen, nahe Klima- und Heizungsanlagen, an Plätzen mit extrem hohen oder niedrigen Temperaturen.
3. In der Nähe von Notausgängen oder Feuerlöschgeräten.
4. An unstablen Plätzen oder Plätzen mit übermäßiger Vibration.
5. An Plätzen, die nicht eben sind.

**F** CETTE MACHINE EST DESTINEE UNIQUEMENT A UN USAGE INTERIEUR NE PAS INSTALLER LA MACHINE DANS LES ENDROITS SUIVANTS

1. A l'extérieur.
2. Directement exposée au soleil, aux endroits excessivement humides ou poussiéreux, aux endroits où il y a des risques de fuite d'eau, près de ventilateurs ou source de chaleur, aux endroits très chauds ou froids.
3. Dans des zones de proximité des sorties de secours ou d'accès aux équipements d'extinction du feu.
4. Dans des emplacements instables ou soumis à de fortes vibrations.
5. Dans des endroits dénivelés.

**I** QUESTA MACCHINA E' PROGETTATA PER ESSERE USATA ESCLUSIVAMENTE IN AMBIENTI INTERNI. NON INSTALLARE LA MACCHINA NEI SEGUENTI LUOGHI.

1. In ambienti esterni.
2. Alla luce diretta del sole, in posti con eccessiva umidità o polvere, in luoghi dove ci siano infiltrazioni d'acqua, vicino ad apparecchi di condizionamento d'aria oppure riscaldamento, in posti eccessivamente caldi o freddi.
3. In luoghi dove potrebbe esserci un'uscita di emergenza o un'attrezzatura per lo spegnimento del fuoco.
4. In posti non stabili o con eccessive vibrazioni.
5. In luoghi non piani.

**SF** TÄMÄ LAITE ON SUUNNITELTU VAIN SISÄKÄYTTÖÖN ÄLÄ ASENNAA LAITETTA SEURAAVIIN PAIKKOIHIN:

1. Ulkotilaan
2. Suoraan aurinkovaloon, kosteisiin tai pölyisiin paikkoihin, vesivuotopaikkojen läheisyyteen, ilmanvaihto- tai lämmityslaitteen lähistölle tai paikkoihin, jossa on erittäin kuumaa tai kylmää.
3. Varaueloskäytävien, muiden pakoteiden tai tulensammutusvälineiden eteen.
4. Epävakaisiin tai täriseviin paikkoihin.
5. Kaltevalle alustalle.

## 5-1 Assembling the Machine

1. Remove the 16off (8 on each seat) Hex Head Screws (M10x25), Flat and Spring Washers and remove the Seat/Cabinet Joint Bracket from the Seat assembly.
2. Remove the 8off Hex Head Screws (M10x25), Flat and Spring Washers from the front of the Monitor Cabinet.
3. Place the Seat Assemblies close to the Monitor Cabinet and connect the connectors.
4. Fit the Seat Assemblies to the Monitor Cabinet using the Seat/Cabinet Joint Brackets and the 24off Hex Head Screws (M10x25), Flat and Spring Washers removed in steps 1 & 2.  
*Note: Take care not to trap any wires when placing the Seat Assemblies against the Monitore Cabinet.*

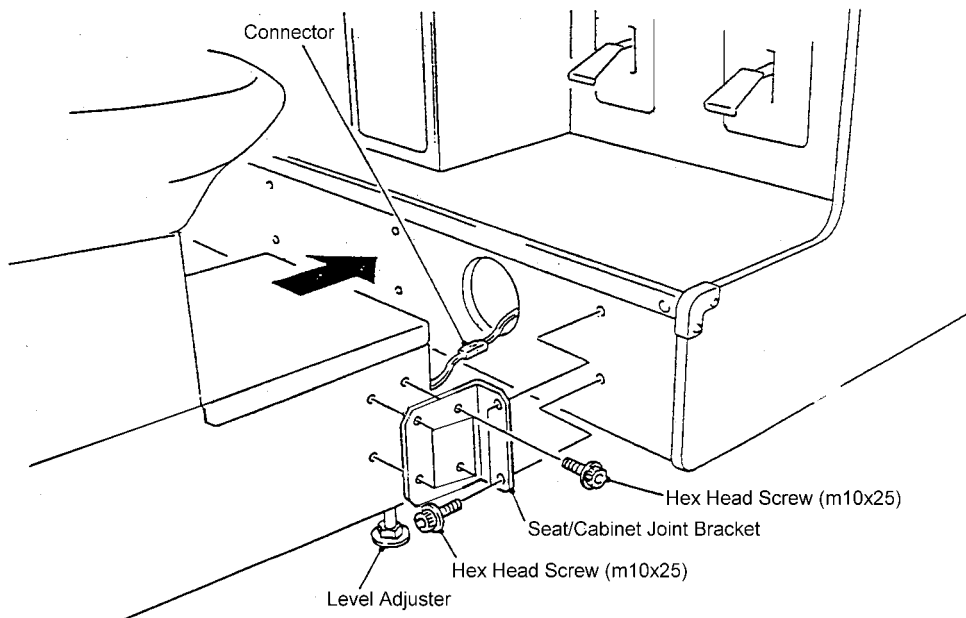

5. When the machine is fully assembled and in its final position, lower the 12 level adjusters (4 on each seat and 4 on the monitor cabinet), with a spanner, so that all the castors are raised from the floor by approximately 5mm, and the machine is level. Tighten the lock nuts with a spanner to ensure that the level adjusters do not move.

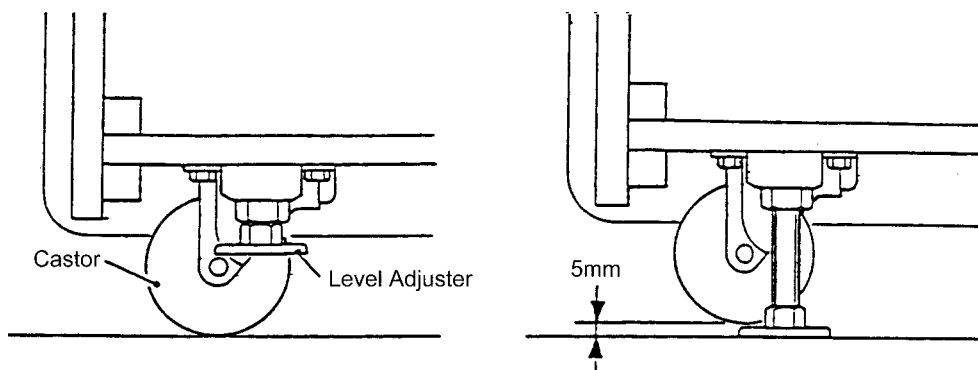

## 6 ADJUSTMENTS

### 6-1 Turning on the Power

After the machine has been installed, turn ON the power. The power switch is located on the rear of the cabinet.

### 6-2 Adjustment Switches

The Adjustment switches are located inside the coin door

1. Service Switch  
Press the service switch to obtain game credits without incriminating the play meter.
2. Test Switch  
Slide the Test Switch ON to enter test mode.  
Test Mode allows the testing and changing of game settings. ([Refer to section 6-3 "Test Mode" \)](#))

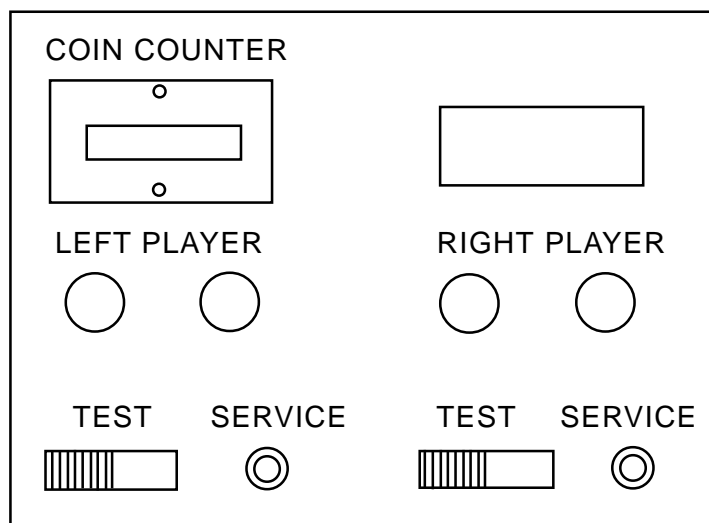

Service Bracket

### 6-3 Test Mode

1. Open the coin door and slide the test switch “on”. The menu screen will be displayed on the monitor.
2. Select the test required by turning the steering wheel left or right. The selected test will ‘blink’.
3. Enter the selected test by depressing the forward pedal (right pedal). Select “EXIT” to return to the “Menu Screen”.
4. After testing is completed, ensure that the test switch is returned to the “OFF” position to return to normal game mode.,

*The Test Switch must always be in the “OFF” position for normal game mode.*

MENU	
COIN OPTIONS	(1) Sets the price of play ( <a href="#">See 6-3-1</a> )
GAME OPTIONS	(2) Sets the game options ( <a href="#">See 6-3-2</a> )
EFFECT TEST	(3) Tests the lamp and drive output ( <a href="#">See 6-3-3</a> )
SWITCH TEST	(4) Tests the Switches ( <a href="#">See 6-3-4</a> )
MONITOR TEST	(5) Used for adjusting the monitor ( <a href="#">See 6-3-5</a> )
SOUND TEST	(6) Used for testing sound and setting volumes ( <a href="#">See 6-3-6</a> )
ADS TEST	(7) Displays accumulated game data ( <a href="#">See 6-3-7</a> )
ARCHIVE DATA	(8) Displays the Game Data for past 30 days ( <a href="#">See 6-3-8</a> )
OTHERS	

**Note:**

*If the steering wheel has not been initialized properly, it may not be possible to select items. If this happens, refer to section 6-4 “Initialization after Replacing Parts”, and initialize the game.*

### 6-3-1 Coin Options

1. Select item (1) "COIN OPTIONS" on the menu screen to set the game cost and related settings.
2. Turn the steering wheel to select the required item.
3. Use the 'Trigger' buttons to adjust the settings.
4. Press 'View Change' Button to return to the menu screen.

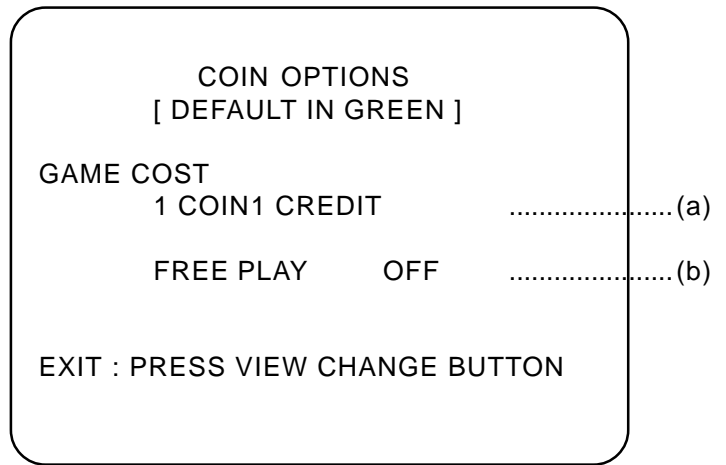

Note :- The price of play on this machine is set within the Cashflow Coin Mech. Ensure that the Coin Options on the screen are set as shown in the following table.

ITEM	CONTENTS	FACTORY SET
(a) Game Cost	No of Coins required for No. of credits - - - - - settable 1 - 9	<b>1 Coin 1 Credit</b>
(b) Free Play	Yes/No	<b>NO</b>

### 6-3-2 Game Options

1. Select item (2) "GAME OPTIONS" on the menu screen to set the game options and related settings.
2. Turn the steering wheel to select the required item.
3. Press the 'Trigger' buttons to adjust the settings. Standard settings are displayed in green.
4. Press 'View Change' Button to return to the menu screen.

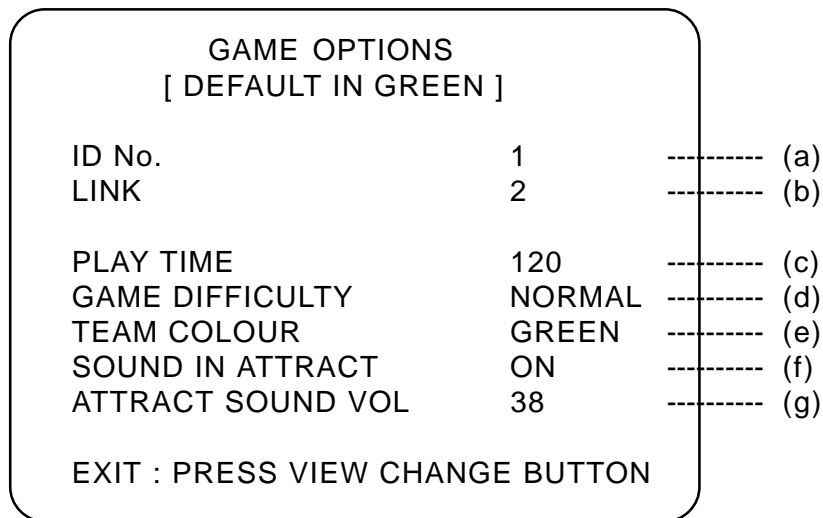

ITEM	DESCRIPTION	FACTORY SET
(a) ID No	For one machine set to 0 and 1 setting from left to right For two machines set to 0 to 4 setting from left to right	0 Left 1 Right
(b) Link	Displays link condition. For one machine, 2 is displayed. For two machines, 4 is displayed. If data is not received, OFF is displayed, and when corrupt data is received, NG is displayed.	2
(c) Play Time	Sets duration of game time from 100, 120, 140, 160, 180 or 300 seconds	120
(d) Game Difficulty	EASY (Families & Children), NORMAL (Regular Players), HARD (Maniac Players)	Normal
(e) Team Colour	For one machine set to GREEN and WHITE from left to right For two machines set to GREEN, GREEN, WHITE and WHITE setting from left to right.	Green & White
(f) Sound in Attract	On / Off On / Off	On
(g) Attract Sound Vol	Sets the volume level during Attract Mode	38



### 6-3-3 Effect Test

1. Select item (3) "Effect Test" on the menu screen to test the lamps and drive output
2. Turn the steering wheel to select the required item.
3. Use the right Trigger Button to activate the test.
4. Press 'View Change' Button to return to the menu screen.

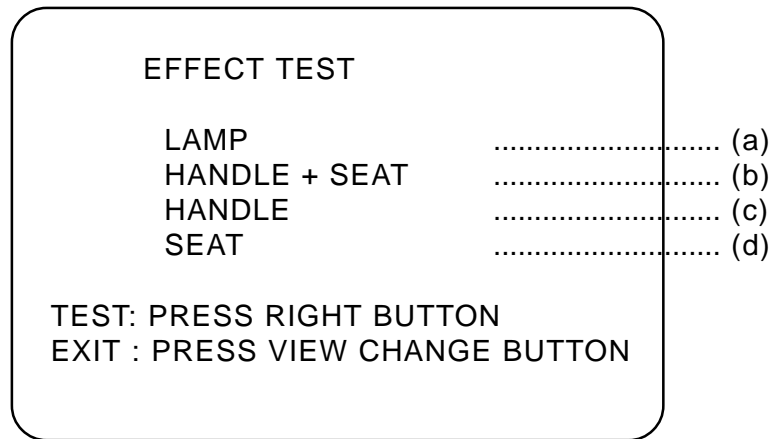

ITEM	DESCRIPTION
(a) Lamp	The lamps light when the trigger button is pressed
(b) Handle + Seat	Not Used
(c) Handle	Not Used
(d) Seat	Not Used

### 6-3-4 Switch Test

1. Select item (4) "Switch Test" on the menu screen to test the switches and Potentiometers
2. Turn the steering wheel to select the required item.
3. Use the right Trigger Button to activate the test.
4. Press 'View Change and Right Trigger' Buttons together to return to the menu screen.

SWITCH TEST		
HANDLE	0000	..... (a)
RIGHT PEDAL	0000	..... (b)
LEFT PEDAL	0000	..... (c)
RIGHT BUTTON	OFF	..... (d)
LEFT BUTTON	OFF	..... (e)
VIEW CHANGE BUTTON	OFF	..... (f)
COIN	OFF	..... (g)
SERVICE SWITCH	OFF	..... (h)
TEST MODE SWITCH	ON	..... (i)
EXIT : PRESS VIEW CHANGE BUTTON AND RIGHT TRIGGER BUTTON		

ITEM	DESCRIPTION
(a) Handle	The numbers increase when the steering wheel is turned to the right and decrease when turned to the left. When the steering wheel is in the centre '0000' is displayed. (It is normal for the last digit to be changing). 'OK' is displayed just before the wheel is turned fully left or right.
(b) Right Pedal	The number increases when the pedal is depressed. 0000 is displayed when the pedal is released. (It is normal for the last digit to be changing). 'OK' is displayed just before the pedal is fully depressed.
(c) Left Pedal	The number increases when the pedal is depressed. 0000 is displayed when the pedal is released. (It is normal for the last digit to be changing). 'OK' is displayed just before the pedal is fully depressed.
(d) Right Button (Trigger)	ON appears when the right trigger button is pressed.
(e) left Button (Trigger)	ON appears when the left trigger button is pressed.
(f) View Change Button	On appears when the view change button is pressed.
(g) Coin Switch	Not Used
(h) Service switch	ON appears when the service button is pressed.
(i) Test Switch	ON is always displayed in this test.

### 6-3-5 Monitor Test

1. Select item (5) "MONITOR TEST" on the menu screen to set up and adjust the monitor.
2. On entering monitor test, the screen will display one of the following test patterns.

GRADATION PATTERN	
CROSSHATCH	GREEN
CROSSHATCH	WHITE
WHITE WINDOW	(H)
WHITE WINDOW	(M)
WHITE WINDOW	(L)
INTERLACE PATTERN	
VIEW ANGLE ADJUST	(CRT)
VIEW ANGLE ADJUST	(PROJECTOR)
FULL WHITE	

3. Use the left trigger button to step forward through the patterns and use the right trigger button to step backward through the patterns.
4. Refer to the monitor manual for monitor adjustments.
5. Press View Change button to return to the main menu.

### 6-3-6 Sound Test

1. Select item (6) "Sound Test" on the menu screen to test the sound and speakers.
2. The following screen will appear on the monitor.

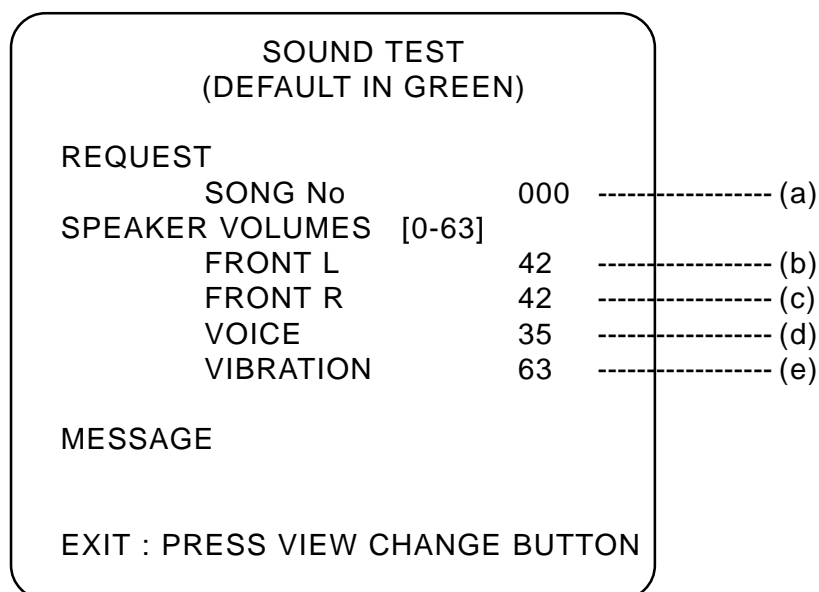

3. Select the required item by turning the steering wheel left or right. The selected item will 'blink'.

4. Pressing the right trigger button will cause the selected value increase.
5. Pressing the left trigger button will cause the selected value to decrease.
6. Depressing the forward pedal (right pedal) will produce the sound of the song number selected. (Request Song 01 will produce a stereo sound test. Sound will be produced from the speakers in the following order:- Left front speaker, Right front speaker, Both front speakers, seat speaker and finally the seat shaker will vibrate.)
7. Pressing the Viewpoint button will return to the Main Menu.

ITEM	DESCRIPTION	FACTORY SET
(a) Song No	Each number up to 256 will produce a different sound. 001 will produce a stereo test	000
(b) Front L	Sets the volume for the front left speaker ~ 00 lowest to 63 loudest	42
(c) Front R	Sets the volume for the front right speaker ~ 00 lowest to 63 loudest	42
(d) Voice	Sets the volume for the seat speaker ~ 00 lowest to 63 loudest	35
(e) Vibration	Adjusts the amount of vibration applied to the seat 00 lowest to 63 highest	63

### **6-3-7 Displaying and Resetting the Game Data**

1. Select item (7) "ADS Test" on the menu screen to view or reset the machine data (book keeping).
2. There are five pages of data. Press the right trigger button to advance forward through the pages and press the left trigger button step back.
3. The data will not be lost at power off and can only be reset as described below.
4. Press the Viewpoint button to return to the Main Menu.

### **Resetting the Data**

1. Depress the right pedal when "RESET DATA" is blinking on page one. The [YES NO] field is displayed.
2. Use the steering wheel to select "YES", and then depress the right pedal to reset the data.

### **6-3-8 Displaying the Archive Data**

1. Select item (8) "Archive Data" on the menu screen to view the game data for the last thirty days.
2. There are three pages of data. Press the right trigger button to advance forward through the pages and press the left trigger button step back.
4. Press the Viewpoint button to return to the Main Menu.

## 6-4 Initialization after Replacing Parts

Initialization must be performed after replacing the Game PCB, ROMS, or Steering and Pedal Potentiometers. If initialization is not performed, the game will not function correctly.

1. Ensure that the steering wheel is in the centre position and that the pedals are fully up.
2. Slide the Test Switch into the ON position while pressing the service button. Keep the service button pressed until the "ADJUST MODE" screen is displayed. (This will take approx. 5 secs.)

ADJUST	
ADCH0	0000
ADCH1	0000
ADCH2	0000
ADCH3	0000

3. Adjustment is completed if '0000' or 'FFFF' is displayed next to "ADCH0", "ADCH1", "ADCH2", and "ADCH3". It is normal for the last digit to be different.  
If the numbers are not '0000' or 'FFFF', switch the Test Switch OFF and repeat step 2.
4. Slide the Test Switch off to return to normal game mode.

## 6-5 Self Test

This game automatically performs a self test each time it is turned on. If there is an error, an error message will be displayed and operation will stop.

## 6-6 Linking Two Machines

1. Ensure that the power is OFF.
2. Loosen the two pozi head screws retaining the link cover bracket, located next to the mains-in socket on the rear of the machine, and remove the link cover bracket.
3. Use the supplied link cables to connect each link board. (See Diag.)

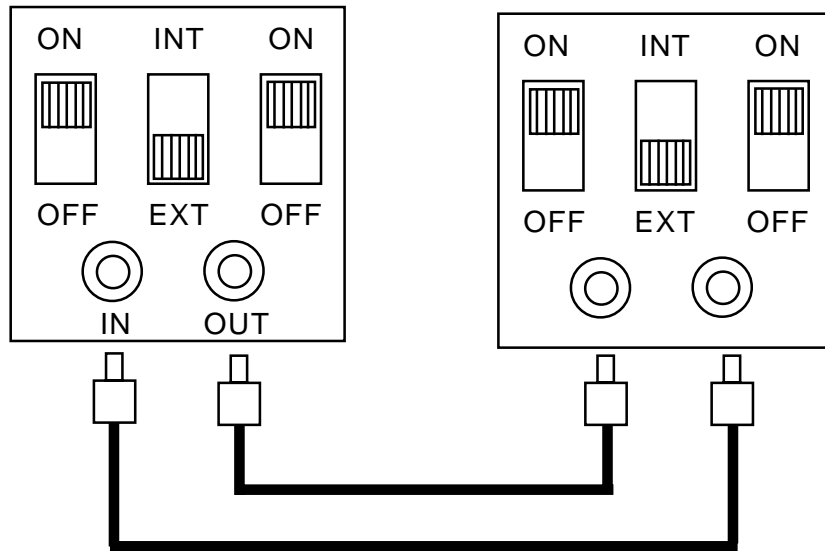

4. Set the link switches to “ON”, “EXT” and “ON”. (Refer to 6-6-1 (below) “Setting the Link Switches”)
5. Refit the link cover bracket, passing the link cables through the slots in the cover bracket.
6. Turn the power to the machine “ON” and set the PCB ID settings. (Refer to Section 6-3-2 “Game Options” item (a).)

### 6-6-1 Setting the Link Switches

The link switches are for setting the connection between machines or seats.

Setting for one Machine  
(2 seats)

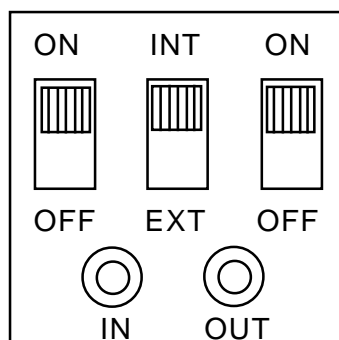

Setting for two Machines  
(4 seats)

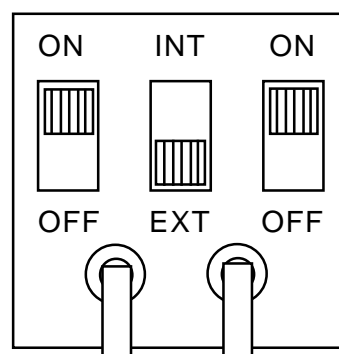

## 7. MAINTENANCE



In order to prevent injury or electric shock to service personnel, ensure that the MAIN POWER IS OFF before attempting any maintenance.



Before performing any work not described in this manual, be sure to contact your distributor to receive instructions or answers to questions.



Vor Beginn aller Wartungsarbeiten (Fehlersuche, Reparaturen etc.) muß der Netzstecker gezogen werden.



Bei Arbeiten, die nicht in diesem Handbuch beschrieben werden, muß vorher der Händler zu Rate gezogen werden, da sonst keinerlei Haftung bei Beschädigungen und Verletzungen übernommen wird.



S'assurer que l'interrupteur soit sor OFF avant de commencer tout travail de maintenance (localisation d'une panne, réparations, etc.)



Si dans ce manuel il manque une information pour réaliser un quelconque travail, contacter votre distributeur, car aucune responsabilité ne sera acceptée en cas de damage ou de blessure.



Assicurarsi che la macchina sia SPENTA prima di incominciare qualsiasi lavoro di manutenzione (guasti, riparazioni etc.)



Se state per iniziare un lavoro non descritto in questo manuale, contattate il vostro distributore per istruzioni poichè non si accetta alcuna responsabilità per danni o ferite.



Varmista, että laite on kytketty POIS PÄÄLTÄ ennen työn aloittamista.



Ota yhteyttä maahantuojaan ohjeita varten, jos joudut tekemään työtehtäviä, joita ei ole esitelty huoltokirjassa, muuten vastuuta vioista tai loukkaantumisista ei ole.

## 7-1 Replacing the Fluorescent Tube, Starter and Lamps

1. Remove the four security screws (M4x16) and remove the glass retaining bracket.
2. Remove the four security screws (M4X20), from the top, and remove the header acrylic.
3. Replace the fluorescent tube or starter.
4. The lamps are a screw fitting. Turn anti-clockwise to remove.
5. Reassemble in reverse order.

 **Warning** The fluorescent tube may be hot. Take care when handling the tube.

 **Warning** Vorsicht bei der Leuchtstoffröhre, da dieses noch heiß sein kann.

 **Warning** Le lampe fluorescente peut être chaude, attention lors de la manipulation.

 **Warning** La lampada fluorescente potrbbe essere calda, attenzione a maneggiarla.

 **Warning** Varo kuumaa loisteputkea.

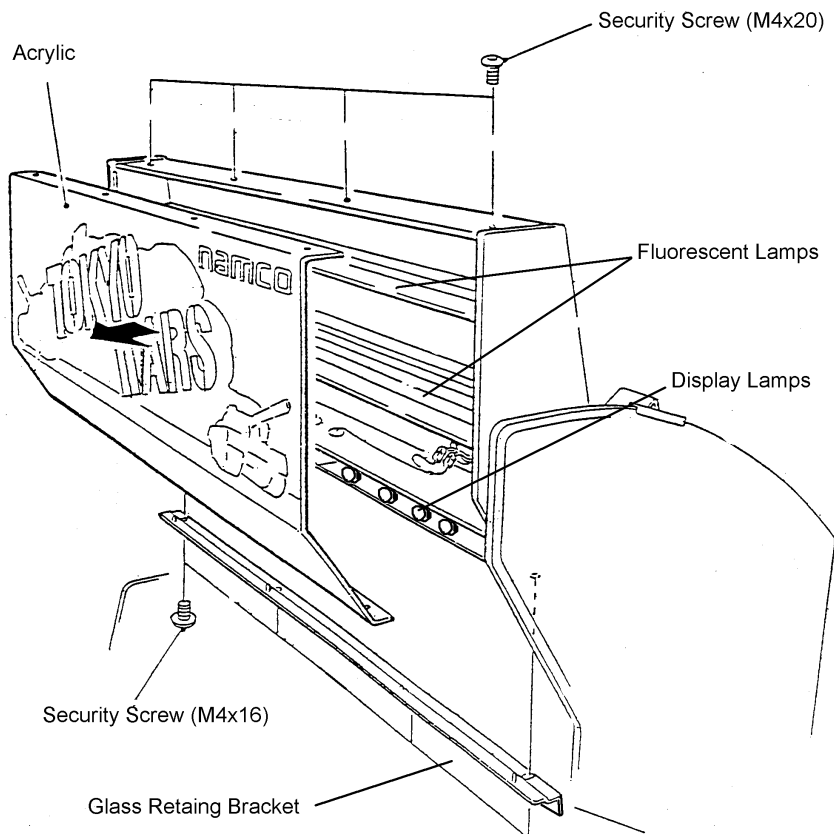



## 7-2 Replacing the Viewpoint and Credit Available Switches

1. Remove the four security screws (M6x25) and washers from the top of the play panel and hinge the play panel forwards.
2. Remove the lamp/switch assembly by pulling it away from the switch body. Replace the switch or lamp.

*Note: When replacing the switch ensure that the wires are replaced to the correct terminals*

## 7-3 Removing the Steering Wheel

1. Carefully remove the round hub cover by gently levering out using a flat blade screwdriver. (*Lever at different points around the hub cover to remove evenly.*)
2. Disconnect the connector. (*Take care not to strain the wires when separating the connector.*)
3. Remove the three button head screws and remove the steering wheel.

## 7-4 Replacing the Trigger Button

1. Remove the steering wheel. ([Refer to section 7-3, above.](#))
2. Remove the four pozi head screws and remove the switch cover.
3. Replace the switch.

## 7-5 Replacing the Steering Potentiometer

1. Remove the four security screws (M6x25) and washers from the top of the play panel and hinge the play panel forwards.
2. Remove the two pozi head screws and remove the potentiometer bracket complete with potentiometer and gear wheel.
3. Loosen the grub screw and remove the potentiometer.
4. When refitting the potentiometer ensure that the locating lug engages in the hole in the bracket and that the grub screw engages on the flat of the potentiometer shaft.

*Note: Ensure that the wires are reconnected to the correct terminals.*

5. After the play panel has been refitted ensure that the game is re-initialized ([Refer to section 6-4](#))

## 7-6 Removing the Pedal Assembly

1. Remove the four security screws (M6x25), flat and spring washers and withdraw the pedal assembly from the front of the machine. (*Take care not to strain the wires.*)
2. Disconnect the connector and remove the assembly.

## 7-7 Replacing the Pedal Potentiometer

1. Remove the pedal assembly. ([Refer to section 7-6, above.](#))
2. Loosen the grub screw and remove the gear.
3. Replace the potentiometer.
4. When refitting the potentiometer ensure that the locating lug engages in the hole in the bracket and that the grub screw in the gear engages on the flat of the potentiometer shaft.

*Note: Ensure that the wires are reconnected to the correct terminals.*

5. After the pedal assembly has been refitted ensure that the game is re-initialized ([Refer to section 6-4](#))

## 8. PARTS

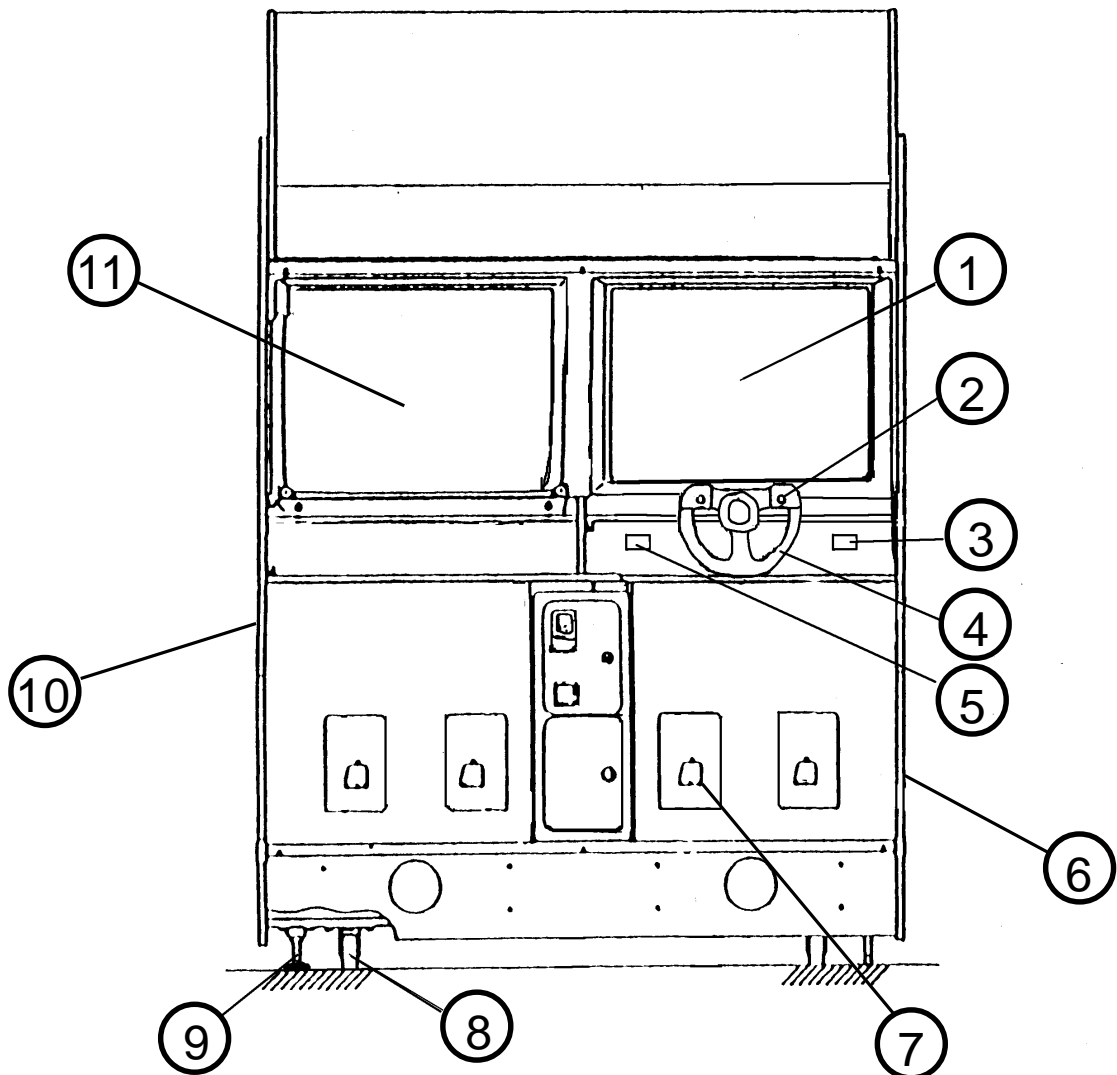

Item	Description	Part No
1	Hantarex 28" Polo Monitor	84000026
2	Trigger Switch	60000013B
3	Steering Assembly	88800070
4	View Change Button Assembly	60200708
5	Credit Available When Lit Button Assembly	60200215
6	Side Decal - RHS	40000375
7	Single Pedal Assembly W/Pot	88800098
8	Swivel Castor 75mm	59000005
9	M16 Adjustable Foot	88300079
10	Side Decal - LHS	40000374
11	Front Glass	31000024
Not Shown	Potentiometer - Pedal & Steering	88800053

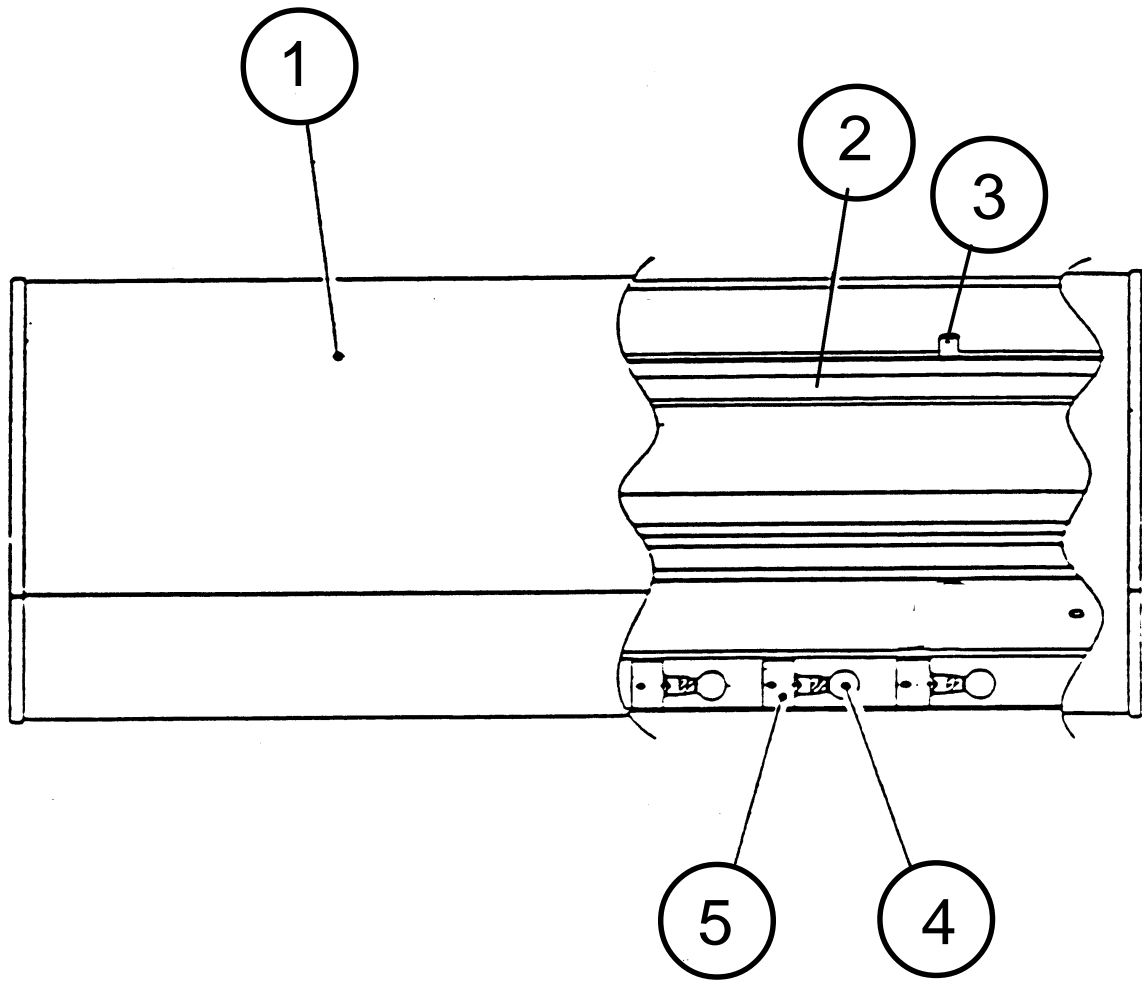

Item	Description	Part No
1	Header Acrylic	30000233
2	Flurescent Tube 4ft	64500014
3	Starter	63000000
4	E14 Golfball Lamp - 240vAC/25watt	64000084
5	E14 Lamp Holder	64800003

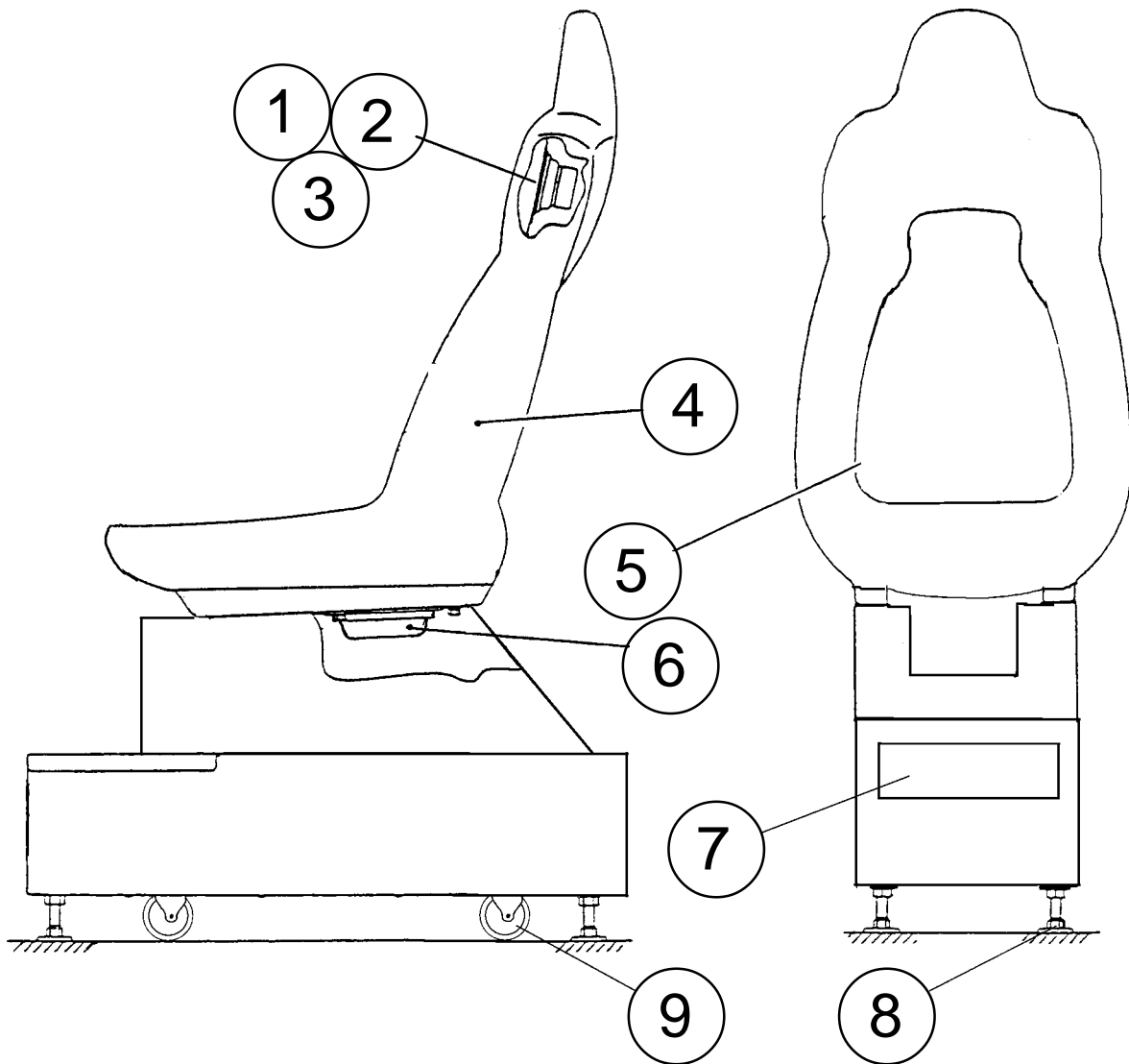

Item	Description	Part No
1	Speaker Plate Black - LHS	88300603
2	Speaker Plate Black - RHS	88300604
3	Loudspeaker - 4 1/2" 20watt	62000006
4	Seat - Dark Blue	46000046
5	Decal - Seat Rear	40000376
6	Loudspeaker - Bass Shaker	62000076
7	Decal - Namco Base	40000036
8	M16 Adjustable Foot	88300079
9	Swivel Castor - 75mm	59000005

# 9. SCHEMATIC

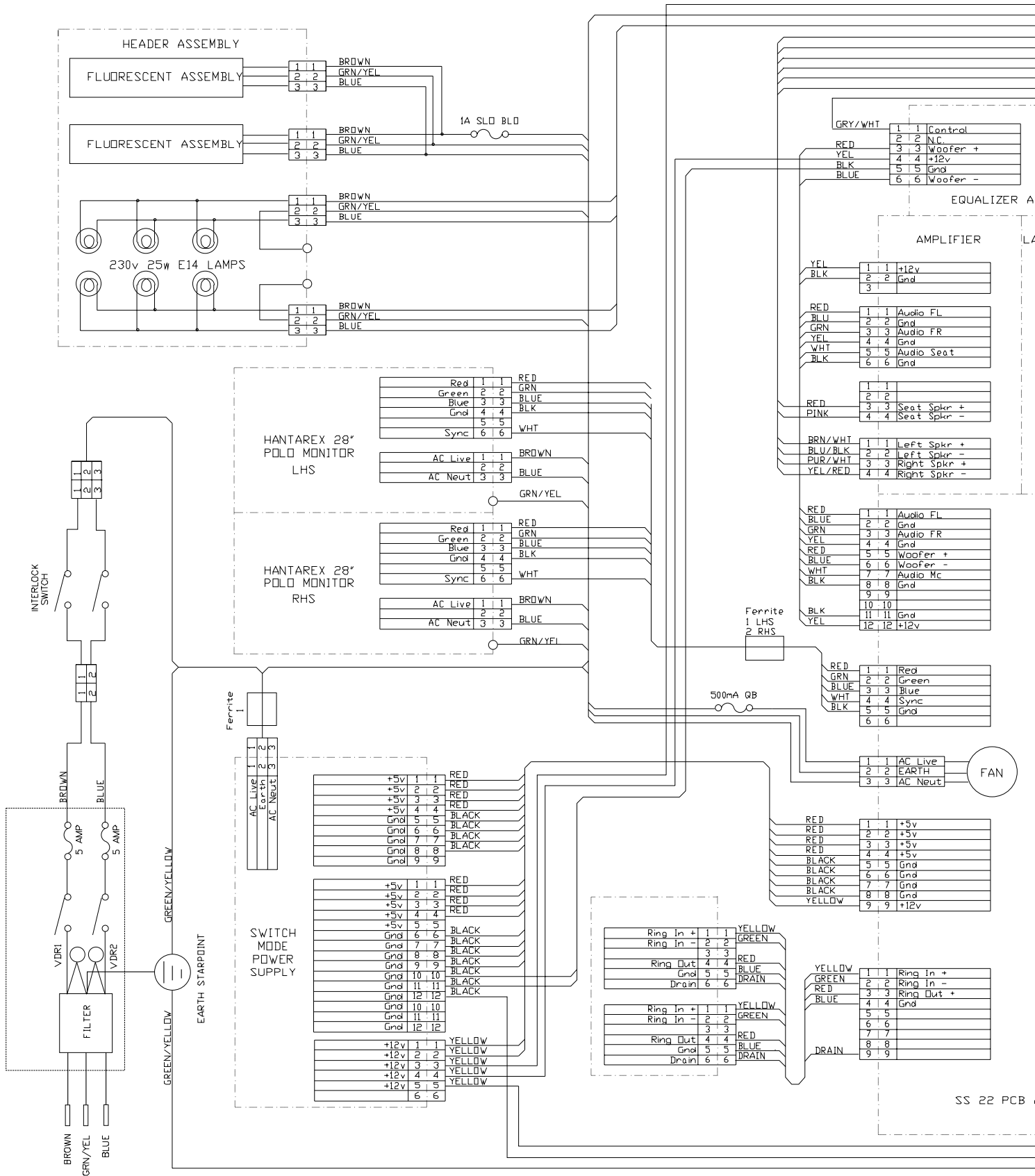

SS 22 PCB

