

Universal Kit

Installation Instructions

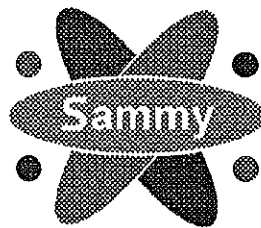

American Sammy Corporation

901 Cambridge Drive
Elk Grove Village, IL 60007
Phone: (708) 364-9787
Fax: (708) 364-9831

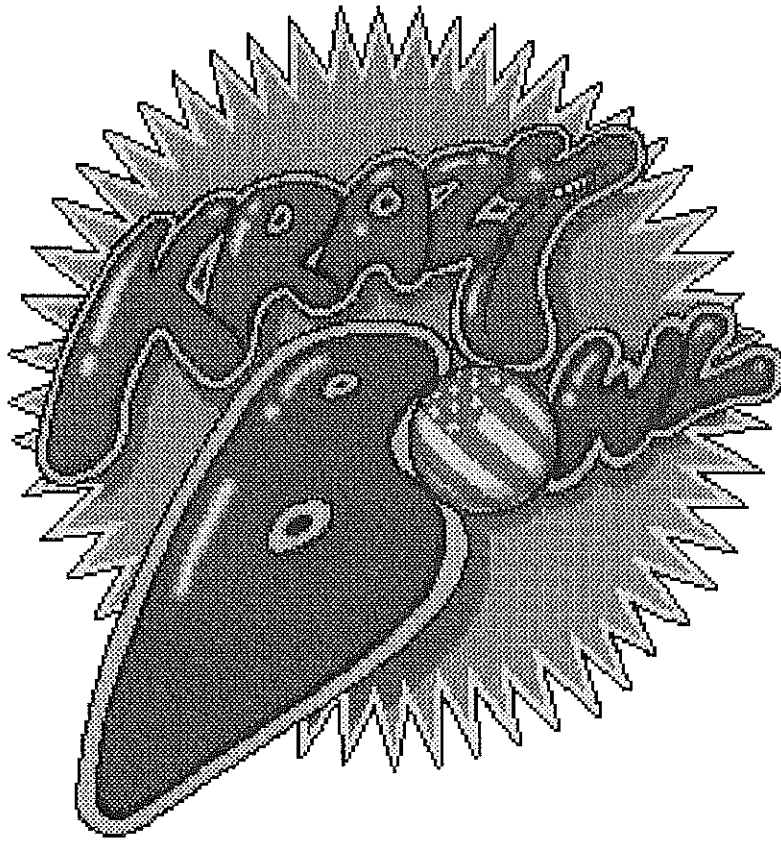

Universal Kit

Installation Instructions



American Sammy Corporation

901 Cambridge Drive
Elk Grove Village, IL 60007
Phone: (708) 364-9787
Fax: (708) 364-9831

TABLE OF CONTENTS

| | |
|--|---------------|
| 1. DIP SW SETTING and more | Page 1 |
| * Mounting the Main P.C.B. | Page 2 |
| * Connector table for Trackball Harness | Page 2 |
| 2. JAMMA CONNECTOR TABLE | Page 3 |
| 3. GAME PACKAGE CONTENTS (Parts # are included) | Page 4 |
| 4. GAME PLAY | Page 5 |
| * How to play | Page 5 |
| * Game Player Instructions | Page 5 |
| 5. OTHERS | Page 6 |
| * Location of Instruction Decals | Page 6 |
| * Clearing of the Battery Backup Data (High Score data) | Page 7 |
| * Cocktail cabinet | Page 7 |
| * Schematic for Trackball Sensor Board | Page 7 |
| 6. INSTALLATION | Page 8 |
| * Inspecting the Kit | Page 8 |
| * Deciding the Control Panel Style | Page 8 |
| * Assembling the Control Panel (Wood control panel only) | Page 8, 9, 10 |
| * Connecting the Trackball Harness | Page 11 |
| * Installing the Main CPU Board | Page 11 |
| * Installing the Marquee and Side Decals | Page 12 |
| * Inspecting the Game play and more | Page 12 |
| 7. TEST MENU | Page 13, 14 |
| 8. TROUBLE SHOOTING | Page 15 |

1. DIP SWITCH TABLE and more

KRAZY BOWL

| DIP SWITCH 1 | | SWITCH POSITIONS | | | | | | | |
|----------------------|-------------------------------|------------------|-----|-----|-----|-----|-----|---|-----|
| FUNCTIONS | SETTING | 1 | 2 | 3 | 4 | 5 | 6 | 7 | 8 |
| COIN CHUTE 1 | 1 COIN 1 CREDIT | OFF | OFF | OFF | | | | | |
| | 2 COINS 1 CREDIT | ON | OFF | OFF | | | | | |
| | 3 COINS 1 CREDIT | OFF | ON | OFF | | | | | |
| | 1 COIN 2 CREDITS | ON | ON | OFF | | | | | |
| | 1 COIN 3 CREDITS | OFF | OFF | ON | | | | | |
| | 1 COIN 4 CREDITS | ON | OFF | ON | | | | | |
| | 1 COIN 5 CREDITS | OFF | ON | ON | | | | | |
| | 1 COIN 6 CREDITS | ON | ON | ON | | | | | |
| COIN CHUTE 2 | 1 COIN 1 CREDIT | | | | OFF | OFF | OFF | | |
| | 2 COINS 1 CREDIT | | | | ON | OFF | OFF | | |
| | 3 COINS 1 CREDIT | | | | OFF | ON | OFF | | |
| | 1 COIN 2 CREDITS | | | | ON | ON | OFF | | |
| | 1 COIN 3 CREDITS | | | | OFF | OFF | ON | | |
| | 1 COIN 4 CREDITS | | | | ON | OFF | ON | | |
| | 1 COIN 5 CREDITS | | | | OFF | ON | ON | | |
| | 1 COIN 6 CREDITS | | | | ON | ON | ON | | |
| DISCOUNT to CONTINUE | NO DISCOUNT | | | | | | | | OFF |
| | START 2 COINS CONTINUE 1 COIN | | | | | | | | ON |
| TYPE of TRACKBALL | 24 COUNTS (U.S.A.) | | | | | | | | OFF |
| | 12 COUNTS (JAPAN) | | | | | | | | ON |

| DIP SWITCH 2 | | SWITCH POSITIONS | | | | | | | |
|------------------|----------------------|------------------|-----|-----|-----|-----|---|-----|-----|
| FUNCTIONS | SETTING | 1 | 2 | 3 | 4 | 5 | 6 | 7 | 8 |
| MONITOR | NORMAL | OFF | | | | | | | |
| | REVERSE | ON | | | | | | | |
| ATTRACT SOUND | ATTRACT SOUND ON | | OFF | | | | | | |
| | ATTRACT SOUND OFF | | ON | | | | | | |
| DIFFICULTY LEVEL | NORMAL | | | OFF | OFF | | | | |
| | EASY | | | ON | OFF | | | | |
| | HARD | | | OFF | ON | | | | |
| | HARDEST | | | ON | ON | | | | |
| GAME STYLE | 10 FRAMES PER CREDIT | | | | | OFF | | | |
| | 5 FRAMES PER CREDIT | | | | | ON | | | |
| TYPE of CABINET | UPRIGHT | | | | | | | OFF | |
| | COCKTAIL TABLE | | | | | | | ON | |
| TYPE of CONTROL | TRACKBALL | | | | | | | | OFF |
| | JOYSTICK | | | | | | | | ON |
| TEST MODE | NORMAL GAME | | | | | | | | OFF |
| | TEST MODE | | | | | | | | ON |

"FACTORY INSTALLED" SETTING

Mounting the Main P.C.B.

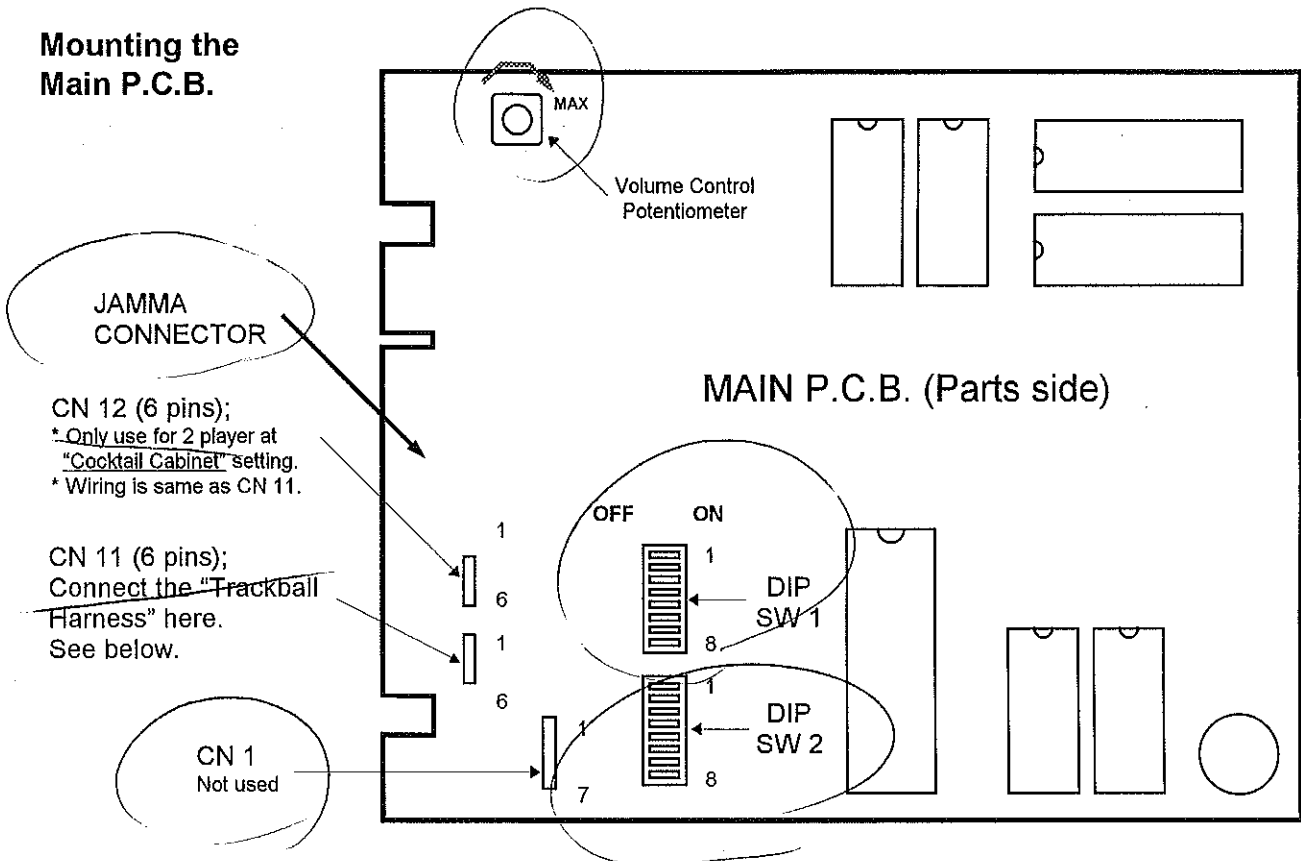

Connector Table for Trackball Harness

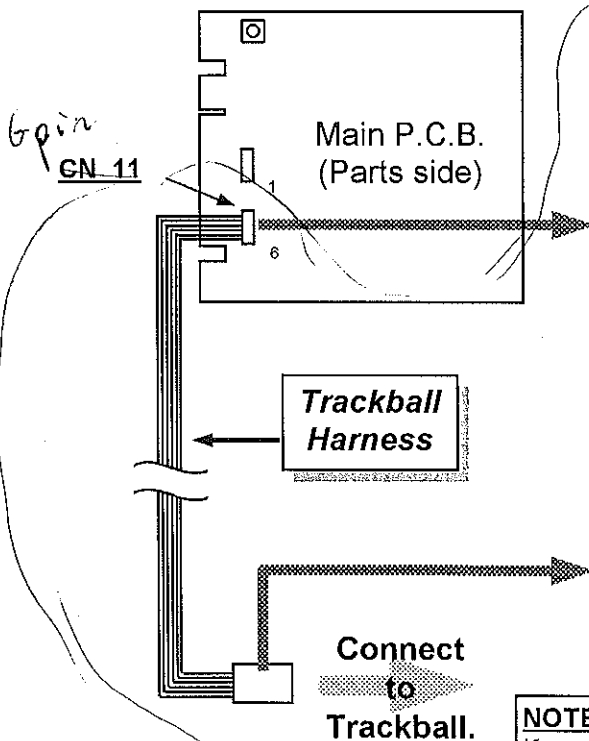

| CN 11 (PCB Side) | | |
|------------------|------|------------------|
| PIN# | WIRE | FUNCTION |
| 1 | RED | + 5 VDC |
| 2 | YEL | X-A (Horizontal) |
| 3 | GRN | X-B (Horizontal) |
| 4 | BLU | Y-A (Vertical) |
| 5 | PUR | Y-B (Vertical) |
| 6 | BLK | GROUND |

| CONNECTOR 6 pin (Trackball Side) | | |
|----------------------------------|------|------------------|
| PIN# | WIRE | FUNCTION |
| 1 | BLK | GROUND |
| 2 | RED | + 5 VDC |
| 3 | YEL | X-A (Horizontal) |
| 4 | GRN | X-B (Horizontal) |
| 5 | BLU | Y-A (Vertical) |
| 6 | PUR | Y-B (Vertical) |

NOTE:
 If your Trackball makes reverse movement for X and Y, you can exchange the pin position 3 and 4 to reverse, or 4 and 5 to reverse at Trackball Connector side to correct.

2. JAMMA CONNECTOR TABLE

KRAZY BOWL

| SOLDER SIDE | | | | COMPONENT SIDE | |
|----------------------------------|---------|----------------|----------------|--------------------|------------------------------|
| FUNCTION | COLOR | EDGE CONNECTOR | EDGE CONNECTOR | COLOR | FUNCTION |
| GROUND | BLK | A | 1 | BLK | GROUND |
| GROUND | BLK | B | 2 | BLK | GROUND |
| (+)5VDC | RED | C | 3 | RED | (+)5VDC |
| (+)5VDC | RED | D | 4 | RED | (+)5VDC |
| | | E | 5 | | |
| (+)12VDC | BLU | F | 6 | BLU | (+)12VDC |
| KEY | | H | 7 | | KEY |
| COIN METER B | WHT/VIO | J | 8 | BLU/BRN | COIN METER A |
| COIN LOCKOUT B | | K | 9 | | COIN LOCKOUT A |
| SPEAKER (-) | BLK | L | 10 | WHT/BLK | SPEAKER (+) |
| | | M | 11 | | |
| VIDEO GREEN | GRN | N | 12 | RED | VIDEO RED |
| VIDEO SYNC | WHT | P | 13 | BLU | VIDEO BLUE |
| SERVICE SW | BRN/WHT | R | 14 | BLK | VIDEO GROUND |
| | | S | 15 | | |
| COIN B | GRN/YEL | T | 16 | WHT/YEL | COIN A |
| NOT USED (2PL SELECT) | RED/BLK | U | 17 | PNK/BLK | SELECT (1PL SELECT) |
| NOT USED (2PL UP) | BRN/BLU | V | 18 | ORN/BLU | NOT USED (1PL UP) |
| NOT USED (2PL DOWN) | ORN/WHT | W | 19 | GRN/ORN | NOT USED (1PL DOWN) |
| NOT USED (2PL LEFT) | ORN/GRN | X | 20 | GRN/BLU | NOT USED (1PL LEFT) |
| NOT USED (2PL RIGHT) | WHT/ORN | Y | 21 | RED/YEL | NOT USED (1PL RIGHT) |
| 2P, T: Left Hook (J: Shoot Ball) | BRN/BLK | Z | 22 | J A RED/WHT | T: Left Hook (J: Shoot Ball) |
| 2P, T: Right Hook (J: Left Hook) | YEL/WHT | a | 23 | J B WHT/RED | T: Right Hook (J: Left Hook) |
| 2P, T: Not used (J: Right Hook) | BRN/GRN | b | 24 | YEL/BLK | T: Not used (J: Right Hook) |
| | | c | 25 | | |
| | | d | 26 | | |
| GROUND | BLK | e | 27 | BLK | GROUND |
| GROUND | BLK | f | 28 | BLK | GROUND |

NOT USED

A
C
O
O
B
A J:
B J:
C J:
D J:

*** NOTE:**

- T: At Trackball Setting.
- J: At Joystick Setting.
- 2 player's input (Z,a,b) are only used when you set the DIP Switch to "Cocktail Cabinet". (DIP Switch 2, #6 to ON)

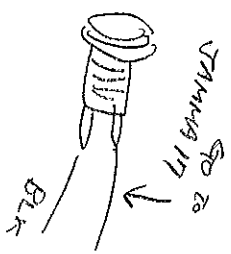

3. GAME PACKAGE CONTENTS (Parts # are Included)

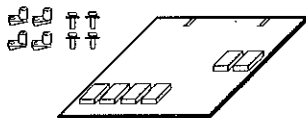

MAIN CPU BOARD
Part # 12-10-001

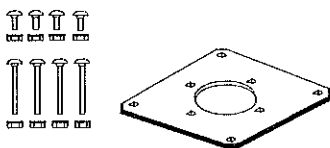

TRACKBALL PLATE
Part # 99-70-400

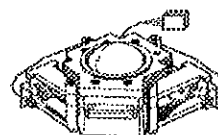

TRACKBALL UNIT with Harness (Blue Swirl Ball)
(Made by Happ Controls)
Part # 99-50-200

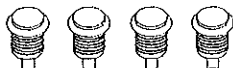

PUSH BUTTON ASS'Y (2 Blue, 1 Red, 1 White)
Parts #
Blue : 99-50-002
Red : 99-50-001
White: 99-50-000

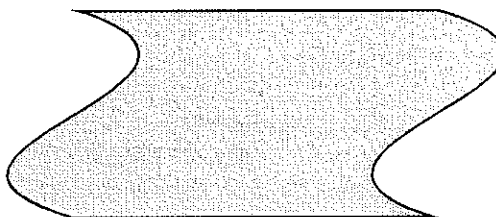

CONTROL PANEL OVERLAY
Part # 12-30-150

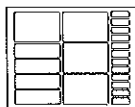

INSTRUCTION DECAL SHEET
Part # 12-30-210

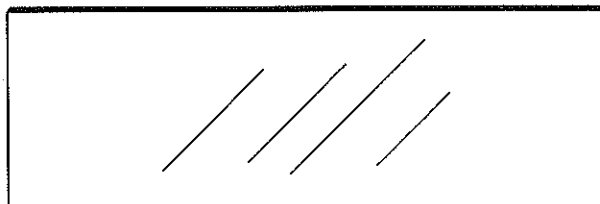

CLEAR LEXAN CONTROL PANEL COVER
Part # 99-30-502



TRACKBALL HARNESS: 5 Feet (6pin)
Part # 99-60-661

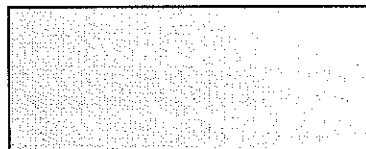

MARQUEE STYRENE
Part # 12-30-100

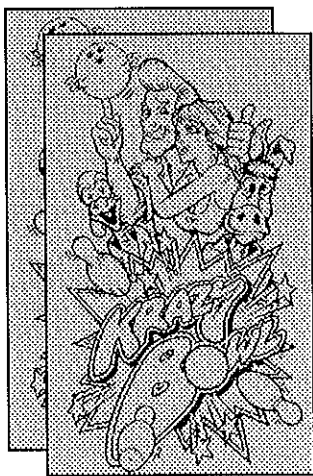

SIDE DECAL SET
Part # 12-30-200

*KC
7-20-00*

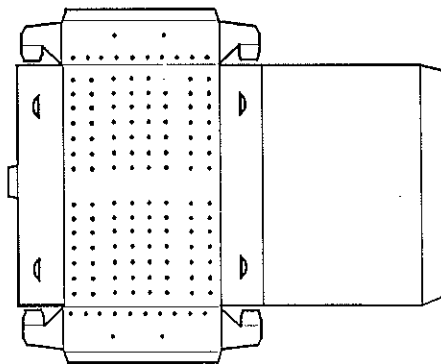

F.C.C. SHIELDING
Part # 99-70-200

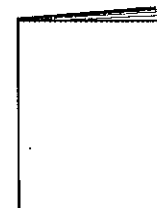

INSTALLATION MANUAL
Part # 12-30-300

4. GAME PLAY

How to play

- Insert coin(s)
- Press Start button. Game select screen will come up on the screen.
- Move Trackball (or Joystick) to Left & Right to select your favorite Game.

Game 1: REGULATION

Scoring is exactly same as Regulation Bowling.

Game 2: SWEEPER

Different pin layout each frame. 2 shots per frame.

A STRIKE scores 30 points.

A SPARE scores 10 points.

- Press Start button again to go to Game play screen.
- 2 to 4 players can BUY-IN at this time. Insert additional coin(s) and press Start button as same number as BUY-IN players.
- You can enter 3 letters of your initials when you make High score.
(Those initials will be memorized until you clear Back up Data. See Page 7)

HIDDEN FEATURE !!!

When the player gets 5 strikes in a row, a Bonus "Red Head Pin" frame will appear 50 % the time. If the player successfully strikes a 6th time (with this Bonus "Red Head Pin"), the player will receive 1 free credit !!!

How to Control

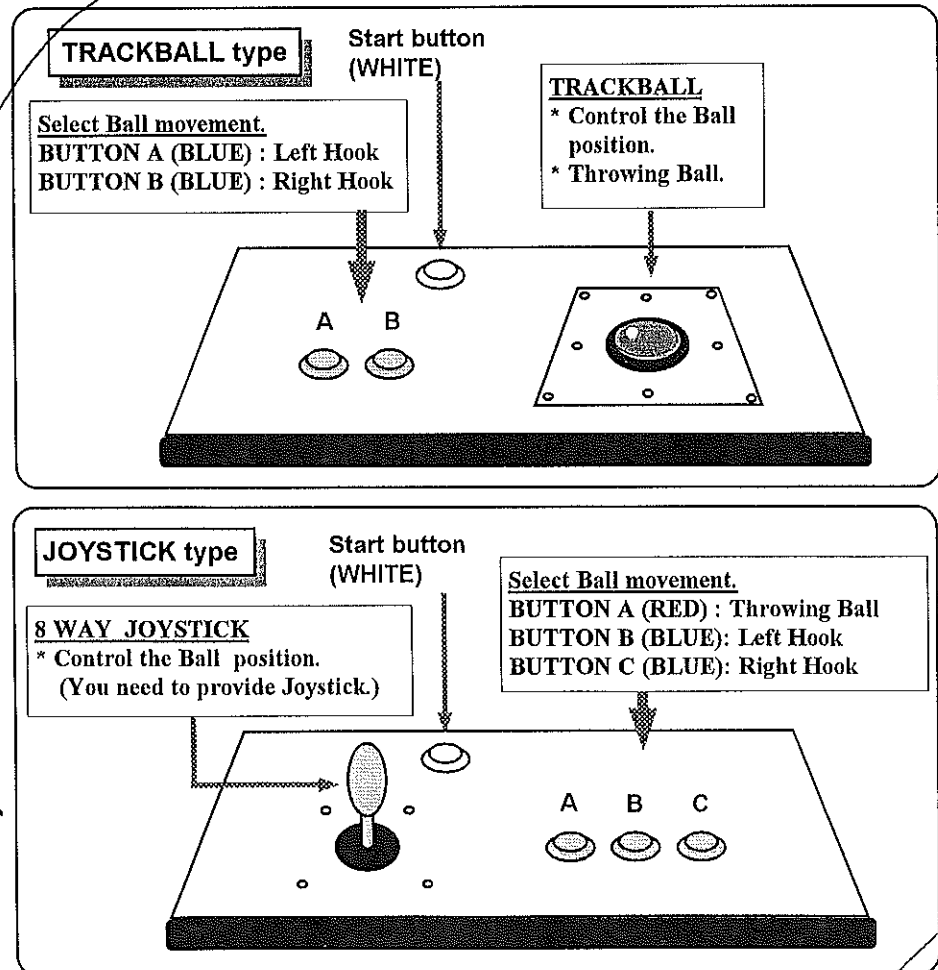
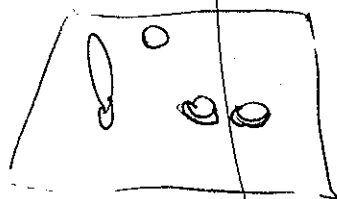
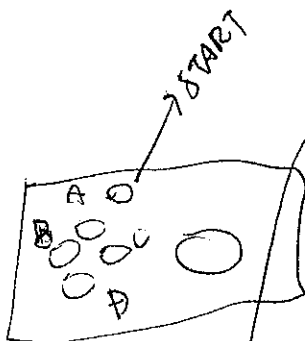

5. OTHERS

Location of Instruction Decals

Decals A,B,C,D are mounted to Monitor Bezel, or any available space on Control Panel.
Others are mounted to Each Controller and Buttons on Control panel as follows;

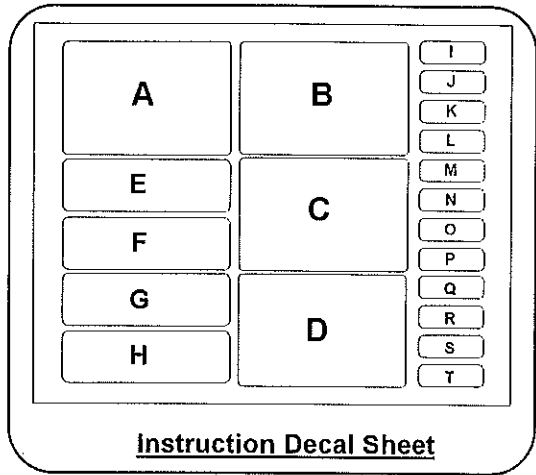

Mount A,B,C,D Here !!!
* If you do not have enough space on Monitor Bezel, see below;

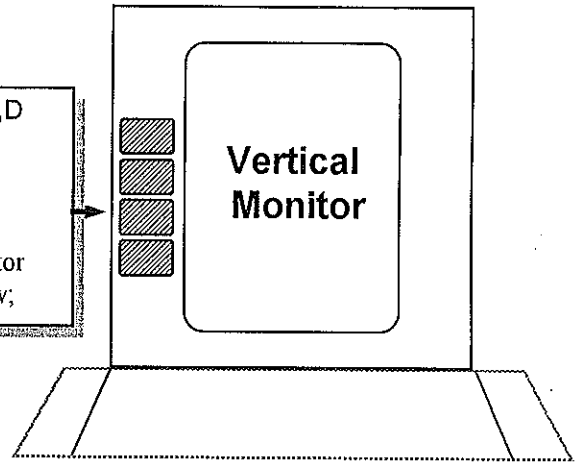

Other Decals E to T need be mounted to the following locations.

TRACKBALL TYPE

* If your cabinet does not have enough space on Monitor Bezel, you can mount the Decals (A,C,D) to following area. ("B" not necessary)

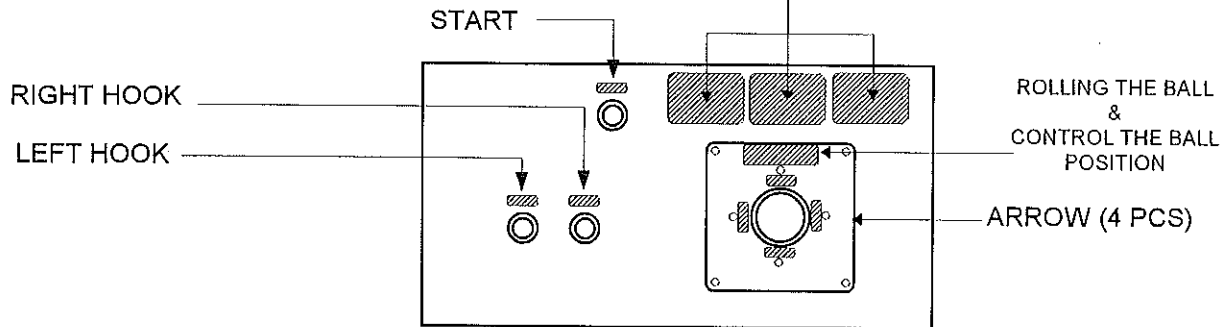

JOYSTICK TYPE

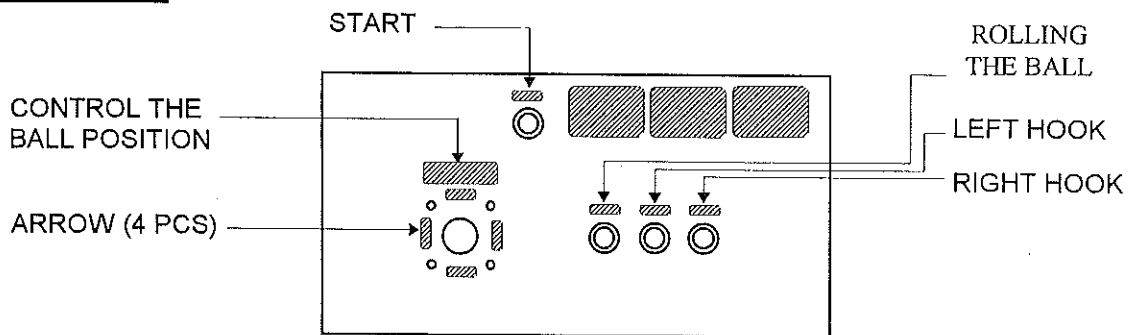

Clearing of the Battery Backup Data (High Score data)

This game has Battery Back up System and can Save the High Score Data with 3 letters when you make Best 5 score. If you want to clear this data, do the following;

- 1) Power off the game.
- 2) Press & Hold the **Start** and **B** button and Re-power ON.
On the screen shows Messages as below.
"Do you want to erase the Data ? Yes : A button No : B Button".
- 3) Press either button.

Cocktail cabinet

If you install the Game in a Cocktail Cabinet, you have to provide one more Trackball and Trackball Harness.(2P Trackball Harness needs be connected to CN12) You need to change DIP Switch 2, #6 to ON. Please reference Page 1 & 2.

Schematic for Trackball Sensor Board

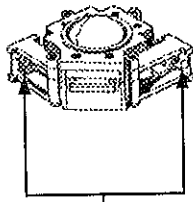

Sensor boards

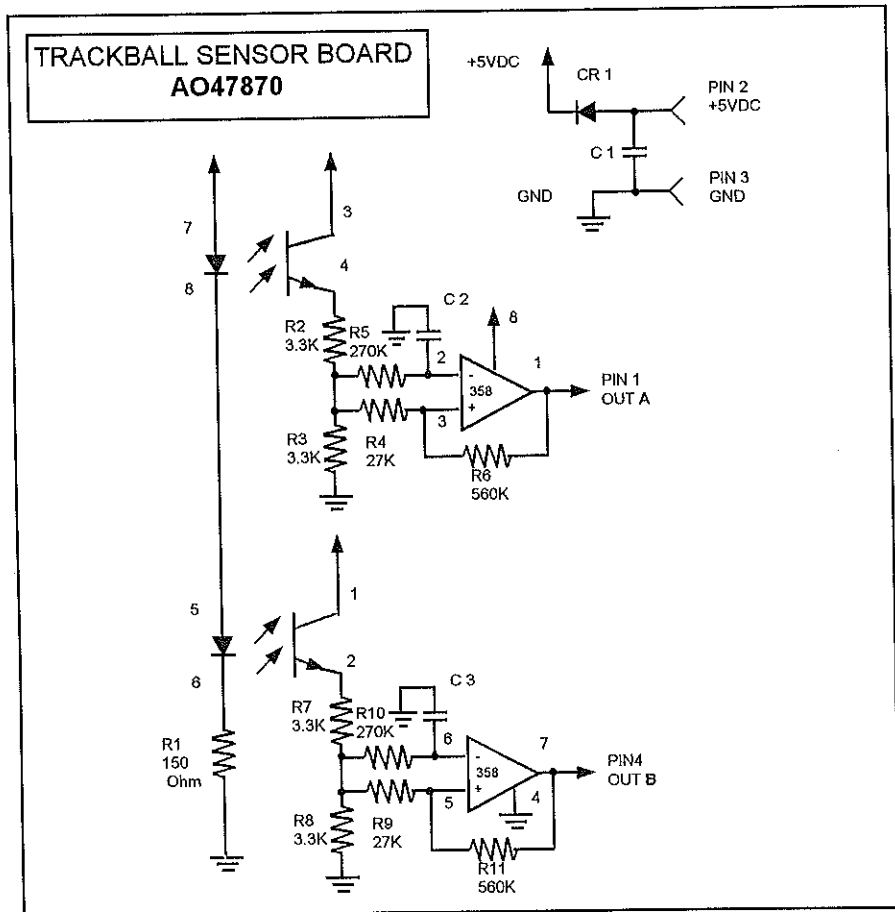

CUT OFF THIS AREA

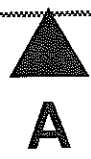

Template for Control panel (Trackball side)

* Please make copy, if you use this template.

Drawing to scale

1/4"φ hole × 4

5 1/2"

3/4"

3/4"

7"

7"

5 1/2"

CUT THIS AREA

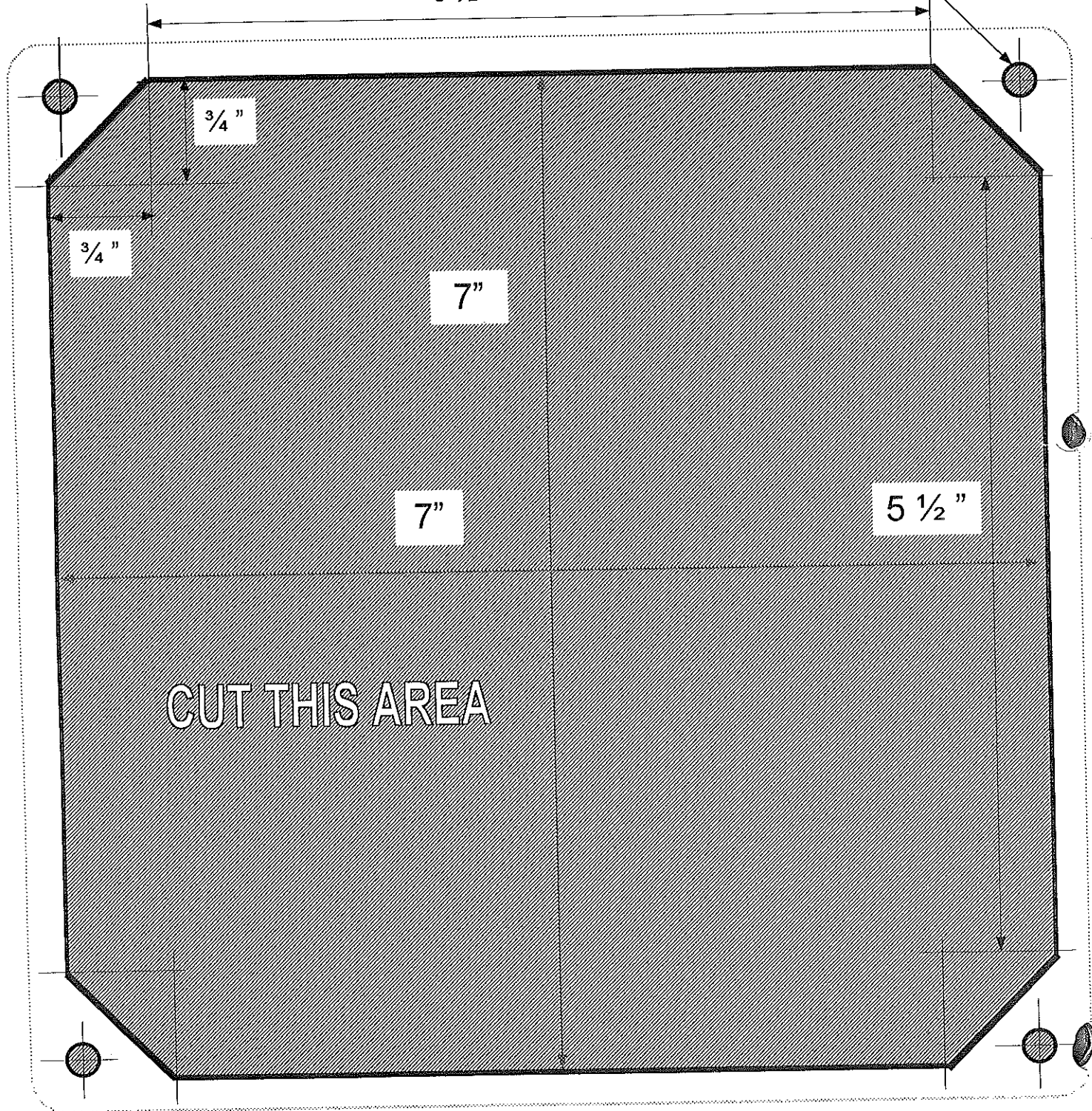

Template for Control panel (Button side)
* Please make copy, if you use this template.

Drawing to scale

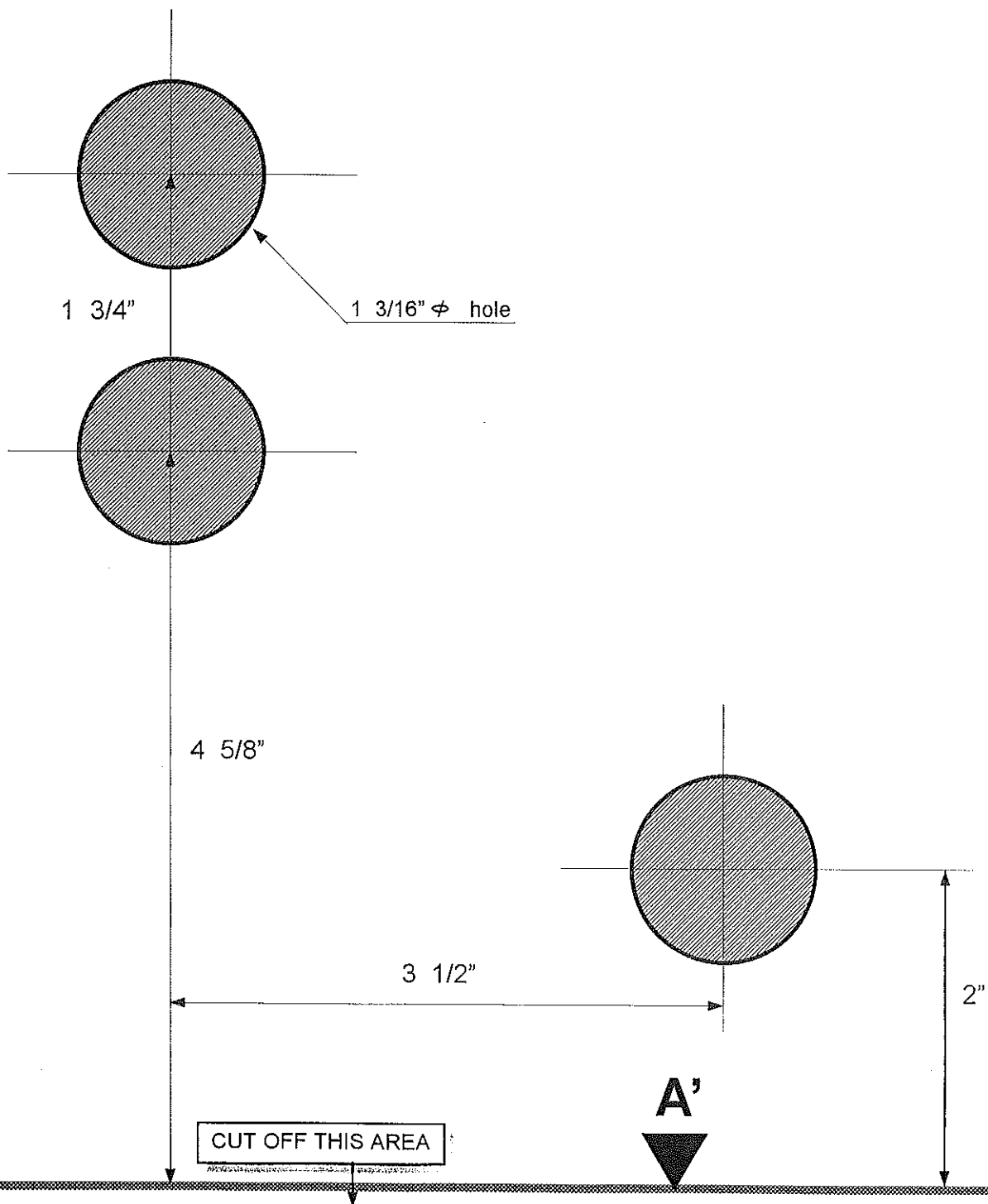

6. INSTALLATION

Inspecting the Kit

Check to see that you have all the parts listed in the kit parts list on page 4. If any part is missing or damaged, contact your distributor with the Krazy Bowl kit serial number, part number, and description of the missing or damaged parts, and date received.

Deciding the Control panel style

The K.Bowl KIT has 2 option settings of Control panel styles as below;

1) Trackball version

2) Joystick version*

If **JOYSTICK**, you can use your control panel base whether wood or metal and exchange to New Buttons, Overlay & Decals from KIT parts.

(ALSO, you will need to Change the DIP Switch 2, #7 to ON. Refer to Page 1.)

* Our KIT does not include Joystick Ass'y, you need to provide.

If **TRACKBALL**, you can use your control panel base which needs to have space for Trackball mounting. Exchange to New Trackball, Overlay, Decals & Buttons from KIT parts or make New Control panel Ass'y as below.

*** NOTE : Before start the Assembly, Check Control panel of your cabinet.**

1) If it's a Wood control panel:

You need to provide New Control panel wood and have to assemble New Control panel. See on this page.

2) If it's a Metal control panel:

Check your control panel whether it has Trackball holes or not. If it does, you can mount Trackball unit directly without Trackball Bracket. But if not, you need to order New control panel with Trackball holes from your distributor.

- Assembling of Metal control panel is almost same as Wood control panel except cutting the holes. Please reference from page 9.

Assembling the Control Panel (Wood control panel only)

- 1) Copy the Templates of Trackball and Buttons (in center of this manual) and stick to Cardboard (you will need provide). Cut out the middle part of the Cardboard.

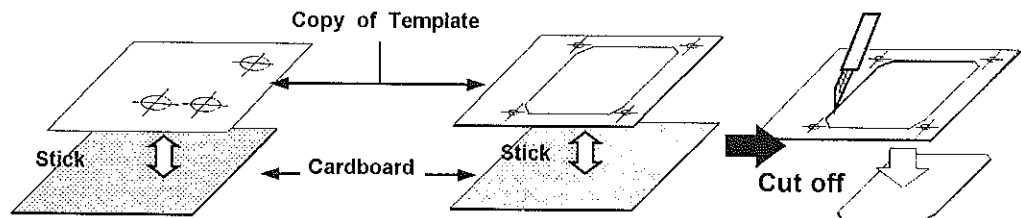

- 2) Set Cardboard to top of the control panel and hold by masking tape. (Refer "**How to mount the CARDBOARD**" on next page.) Mark center position of each circle (7 points) by Needle. And also, mark the inside shape of Trackball's Hole by marker.

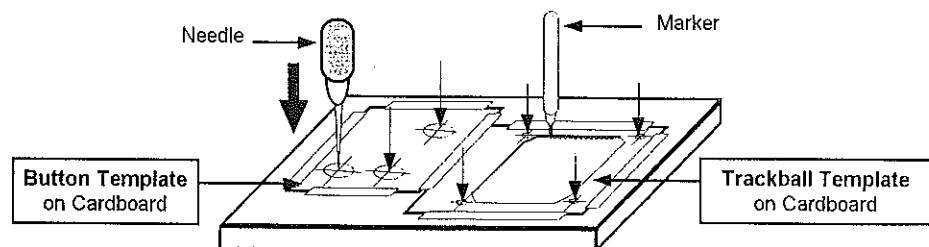

***How to mount the CARDBOARD**

Align the Mounting and Drill Location on the Control panel as below. **(NOT TO SCALE)**

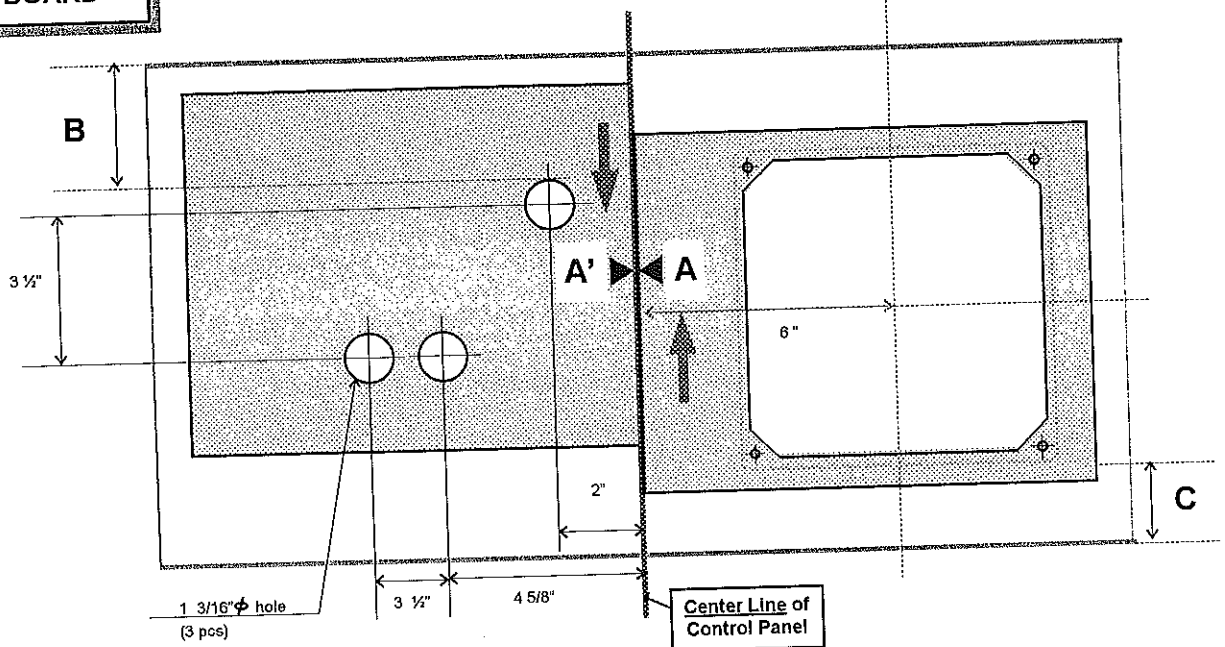

1. Find out **Center Line** of Control panel.
2. Put Cardboard Template like above. Matching **A** and **A'** is our suggested position. We suggest that keep enough of **B** and **C** about **2"**.

NOTE:

- You can adjust these dimensions if your control panel does not have enough space. Slide up & down the two Cardboard Templates. (See above Arrows on picture.)
- Trackball needs be mounted on **Right** side of control panel, since the **Bowling Lane** in game mode is displayed on the **Right** side of screen.

- 3) Drill four 7/32" or 15/64" holes for Screws of Trackball plate. Drill three 1 3/16" holes for Start button and L & R Hook buttons. Use Drill and Saw to make Trackball Hole. Then remove Cardboard.
- 4) Install the Control Panel Overlay on the control panel. Make sure to stick Overlay as close to center position on control panel as possible. Use a Knife to trim the outside edge and to cut out the holes for the Buttons, Screw holes, and Trackball holes.

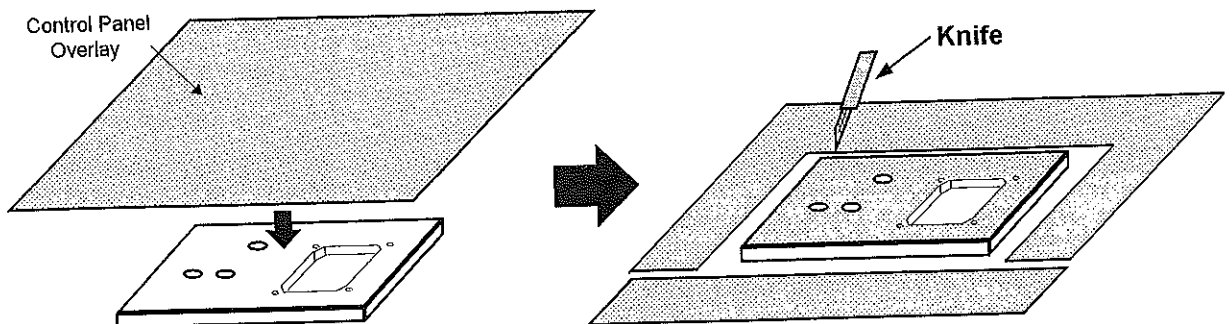

- 5) Lay the CLEAR LEXAN CONTROL PANEL COVER on top of the control panel and mark the outside shape of the panel on the plastic. Also mark the button, screws and Trackball holes as close as possible to the locations shown on the template. Lastly, mark the positions of the six or eight holes* that will be used for securing the cover to the control panel. These holes can be placed anywhere near the corners - wherever space permits.
* **You need to provide those screws and match size of hole.**

- 6) Using a knife, cut the control panel cover to its correct outside shape. Tape the template to the control panel cover. Cut the square holes for Trackball and the button holes.
- 7) Punch out the instruction decals from the sheet and mount to Control Panel Overlay. Please refer to Page 6 of "Location of Instruction Decals".
- 8) Drill the six or eight 5/16" holes that will be used to mount the cover to the Control Panel. Drill the four 5/16" holes to mount the Trackball plate.

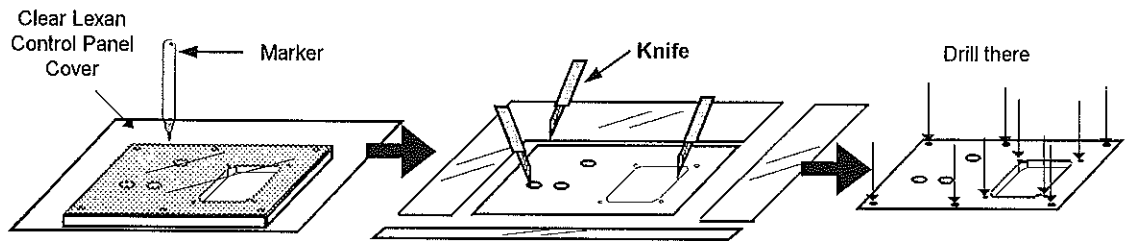

- 9) To prevent injury, carefully deburr all the edges of the control panel cover.
- 10) Install the Control Panel Cover, Trackball Plate, Trackball, and each button (Start, Left Hook, Right Hook) to control panel. Please reference the color of buttons on Page 7. Use 8 Screws & Nuts for mounting the Trackball and Plate.

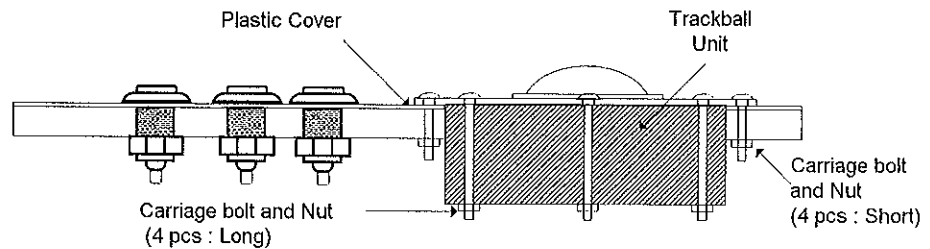

IMPORTANT !!!
MOUNTING THE TRACKBALL

MONITOR SIDE

FRONT SIDE

Position of Sensor Board must be this way when you install our KIT Trackball and Trackball Harness.

If you can only mount the Trackball the other way because your control panel has not enough space to mount this way, you may have to re-locate pin position of Trackball Harness Connector.

Please refer to Connector Table of Trackball Harness on Page 2.

Connecting the Trackball Harness

The Trackball Harness is only a plug between Trackball Connector to CN 11 on Main P.C.B. (See below)

* Make sure to tighten up Trackball Harness with Main Harness by Cable Tie.

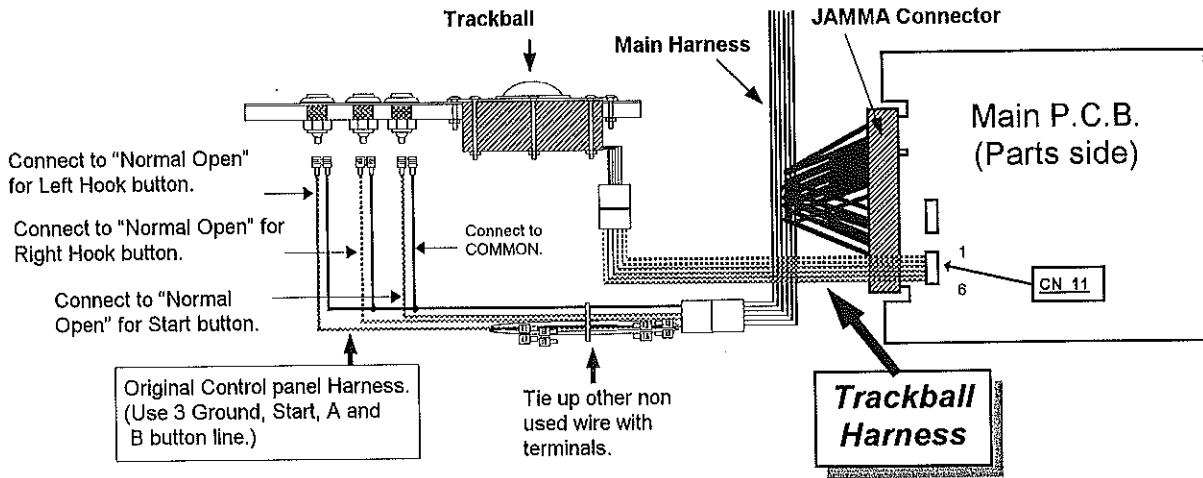

Installing the Main CPU Board

- 1) Remove the Old P.C.B. and check your Cabinet is JAMMA Harness or not. If it's not, you need to provide and install the JAMMA Harness.
- 2) Before plugging in the Game P.C.B., turn on the power to the game, and check +5 Volts DC on pins 3,4,C, and D of the JAMMA connector: +12 Volts DC on pins f and 6.
- 3) Check that the Monitor and the attraction lamp have power.
- 4) Check your DIP Switch setting chart. If you need to change "Coinage, Difficulty Level, Cabinet style of game.....etc", please adjust DIP Switch. Reference "DIP Switch Table" on Page 1.
- 5) After you have checked above, install the Main P.C.B. set in the cabinet. Mount the P.C.B. legs by 4 screws to 4 corner of Main P.C.B. The Standoffs support the Main P.C.B.
- 6) Use 4 wood screws to mount the Main P.C.B. with F.C.C. Shielding as below. (You need to provide those screws.) Connect JAMMA connector and Trackball Harness to Main P.C.B. Refer to above picture.

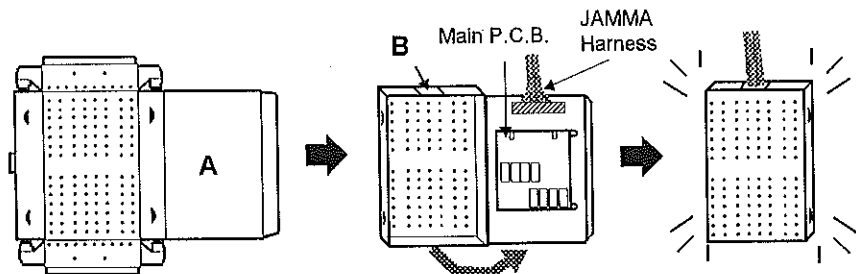

1) Make Box. Main P.C.B. need be mounted side on A.

2) Use 4 screws and P.C.B. Legs to mount the Main P.C.B. Connect JAMMA Harness to Main P.C.B. then cut out B.

3) Then close the Box.

Installing the Marquee and Side Decals

Remove the Marquee, Side decals, graphics, and adhesive. If the cabinet sides are damaged, repair them before putting on the new decals. Then install New K.Bowl Marquee and Side Decals. See below:

Marquee

Cut* the K.Bowl Marquee to exactly the same size of original Marquee Plastic-glass. Then slide in between Top of cabinet & plastic-glass.

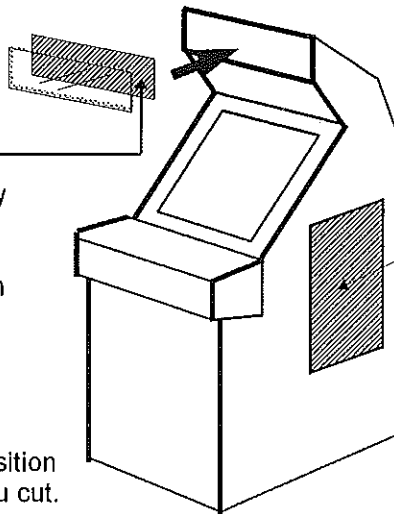

Side decal :
Stick to Both sides of Cabinet.

* Check the center position of Marquee when you cut.

Inspecting the Game play and more

When you finish all of above, Check the Game with the TEST MENU.

- 1) Change DIP Switch 2,#8 to ON. Then power on the Game. You can see the TEST MENU on screen.
- 2) Refer Page 13 & 14 to check Monitor Color and Size, DIP Switch setting, Trackball (or Joystick) and Button operation.

If all's OK, power off and change DIP Switch 2, #8 to OFF and re-power on the Game. Screen will be back to "Game mode".

- 3) Insert 25¢ or Token and check following;
 - The # of Credit(s) are show at bottom of the screen.
 - Coin counter of your cabinet must work as each coin is inserted. If not,check the wiring between JAMMA Connector to the Coin switch or Coin Counter in cabinet or check the Coin Mechs.
- 4) Press Start button and play the game. "Game Play" is described on Page 5.
- 5) Check and Adjust Main Volume. Turn the Volume Potentiometer of cabinet to adjust. If the cabinet does not have, adjust the Volume control potentiometer on Main P.C.B.
 - Location of the Volume control potentiometer is illustrated on Page 2.
- 6) Check Marquee light. If not lit, may need to change the Bulb or Starter.

7. TEST MENU

Entering the TEST MENU

If you need to check the condition of the game circuitry and controls, you can use TEST MENU. Turn ON the DIP Switch 2, #8 and re-power on the game. The game will go into TEST MODE and the screen appears as following:

Select TESTS

Use screen (Right side) to choose which of the 6 screens you want to see. Move cursor by Trackball (or Joystick) up & down to select each. Then press start button to enter the test.

* Press start button

Press start button to go to next screen. (Except "I/O TEST" screen)

* Returning to the TEST MENU

Press A & B button same time at any 6 screens.

* Returning to the Game screen

Turn back to OFF the DIP Switch 2, #8 and re-power on the game. The game will go back to Game screen.

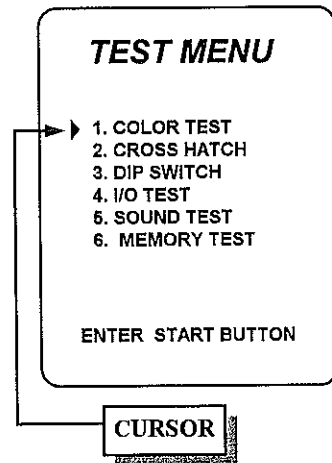

1. COLOR TEST

Use this screen to check Color of monitor. The color blocks in the center should be four bands (Red, Green, Blue, and White from top to bottom), each with a color scale from bright to dark, left to right. If the screen does not match this description, adjust the Monitor as described in the Monitor's manual.

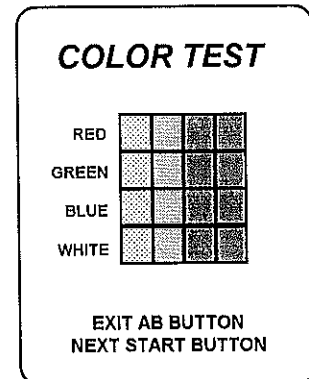

2. CROSS HATCH

Use this screen to check Size of picture. Cross Hatch test pattern has a white grid on a black background. Check following:

- The grid line should be straight, and the line should not have excessive pincushion or barrel distortion.
- "Out" line of grid line is the same size as "Out" line of game screen. So, "Out" line should be able to be seen with no overflow of grid lines on screen.

If these are not as above, adjust the Monitor as described in the Monitor's manual.

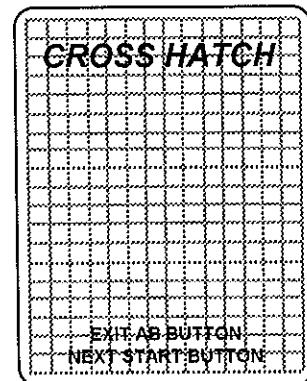

3. DIP SWITCH

Use this screen to see how all the DIP Switches are set. You can view and change the coinage and game options on this screen (see Right side of picture). The coinage and game option setting are explained on DIP Switch table (page 1). To change a setting, slide the appropriate toggle on the DIP Switch to ON or OFF. The screen will immediately display these changes.

DIP SWITCH

COIN CHUTE A : 1 COIN 1 CREDIT
 COIN CHUTE B : 1 COIN 1 CREDIT
 HALF COIN : OFF (A-7)
 TRACKBALL : 24 COUNTS (A-8)
 SCREEN FLIP : OFF (B-1)
 DEMO SOUND : ON (B-2)
 GAME LEVEL : NORMAL (B-3,4)
 CABINET TYPE : TYPE A (B-6)
 CONTROL : TRACKBALL (B-7)

DIP SW A : 1 1 1 1 1 1 1 1 <0: ON 1: OFF>
 DIP SW B : 1 1 1 1 1 1 1 0

EXIT AB BUTTON
 NEXT START BUTTON

4. I/O TEST

Use this screen to check all the Coin switches, control panel switches, and Joystick switches in this game (See Right side of picture). To check the functioning of each switch, activate it and watch the corresponding OFF letters change to ON. If the ON and OFF letters do not appear correctly, check the Harness connections, Switches, and Joystick controls.

I/O TEST

| | | | |
|----------|---|-----|-----|
| JOYSTICK | | 1P | 2P |
| RIGHT | : | OFF | OFF |
| LEFT | : | OFF | OFF |
| DOWN | : | OFF | OFF |
| UP | : | OFF | OFF |

| | | | |
|-----------|---|------|------|
| TRACKBALL | | | |
| X | : | 000H | 000H |
| Y | : | 000H | 000H |

| | | | |
|--------|---|-----|-----|
| BUTTON | | | |
| SHOT 1 | : | OFF | OFF |
| SHOT 2 | : | OFF | OFF |
| SHOT 3 | : | OFF | OFF |

| | | | |
|---------|---|-----|-----|
| START | : | OFF | OFF |
| SERVICE | : | OFF | OFF |
| COIN A | : | OFF | OFF |
| COIN B | : | OFF | OFF |

EXIT AB BUTTON

NOTE : Trackball movement check
 4 numbers of Y will count up when you roll Trackball to forward.
 4 numbers of Y will count down when you roll Trackball to backward.
 4 numbers of X will count up when you roll Trackball to right.
 4 numbers of X will count down when you roll Trackball to left.

5. SOUND TEST

Use this screen to check all game sound. Move Trackball (or Joystick) Up & Down to select sound name. Press A button to start the sound. Press B button to stop the sound.

SOUND TEST

SOUND CODE
 22H
 COIN

SELECT : 1P TRACKBALL
 START : 1P SHOT 1
 STOP : 1P SHOT 2

EXIT AB BUTTON
 NEXT START BUTTON

6. MEMORY TEST

Use this screen to check RAM, ROM on Main P.C.B. Main P.C.B. will automatically check those when you enter this screen. If no problems, letters of OK will appear on screen for RAMs and ROMs. If NG, check the mounting of RAM or ROM Main P.C.B. and if still NG, need to repair.

MEMORY TEST

| | |
|-----------|----|
| WORK RAM | OK |
| OBJ RAM | OK |
| COLOR RAM | OK |

| | |
|-------|----|
| ROM 0 | OK |
| ROM 1 | OK |

EXIT AB BUTTON
 NEXT START BUTTON

8. TROUBLE SHOOTING

Please reference the table below, if you have any problems.....

| Problem | Suggested Action |
|--|--|
| Trackball (or Joystick) problems | <ul style="list-style-type: none"> a) Check the harness and connectors of "Control panel". b) Check the Sensor boards of Trackball (or switches on the Joystick) by using the I/O test screen in the TEST MENU. c) If you took the control panel apart, have you re-assembled it correctly ? d) Make sure all the parts on the control are good. Repair or replace parts. |
| Coin Mechanism Problem | <ul style="list-style-type: none"> a) Check the wiring to the Coin switch and Coin Counter. b) Test the Coin switch with the I/O TEST screen in the TEST MENU. |
| Game Play Problem | <ul style="list-style-type: none"> a) Check the harness and connectors of "Control panel". b) Perform the I/O TEST. c) Check the voltage levels on the Main P.C.B. |
| Sound Problem | <ul style="list-style-type: none"> a) Is the speaker volume turned up ? (Volume can be adjusted on Main P.C.B.) b) Check the Voltage levels on the Main P.C.B. edge connector. c) Check the wiring from the Main P.C.B. to Speaker. d) Check the voltage level to the Main P.C.B. e) Replace the speaker. |
| Monitor Problem | |
| * Screen area wavers or is too small | <ul style="list-style-type: none"> a) Check the correct power voltage to the Monitor P.C.B. b) Check the correct high power voltage to the Monitor. |
| * Picture is wavy | <ul style="list-style-type: none"> a) Is the monitor ground connected to the monitor ? b) Are the SYNC inputs connected properly ? |
| * Picture is upside down. | <p>Check DIP Switch 2, #1. This toggle should be in the OFF position for a normal screen. Another possibility is if you serviced the Monitor, you may have connected the wires incorrectly. Switch the Horizontal or Vertical yoke wires on Monitor P.C.B.</p> |
| * Convergence, purity or color problems. | <p>Use the screen in the TEST MENU to adjust the Monitor. Use the adjustment procedures in your Monitor Manual.</p> |
| * Picture is not centered | |
| * If the screen is dark... | <ul style="list-style-type: none"> a) Check line (Main) fuse. b) Check Brightness on Monitor is turned up. c) Are the edge connectors on the Main P.C.B. and JAMMA connectors tightly connected ? d) Check all of the items below. If you answer no to any question, you have a problem with the Monitor, not with the game circuitry. See your Monitor service manual. <ul style="list-style-type: none"> * Do you have power to the Monitor ? * Are the Monitor's filaments lit ? * Do you have high voltage to the Monitor ? e) Are the voltage levels to the Monitor P.C.B. correct ? (Power voltage is 100VAC or 110VAC, depending on the type of Monitor. Video signal voltage is 0.5 to 3.5 Volts.) If the level is not correct, check the connectors and the harness. |

Warranty, Repair and Return Policy

American Sammy Corporation (ASC) warrants all products to be free from defective materials and workmanship for a period of Thirty (30) days from the ASC invoice date unless otherwise specified in writing by ASC. The extent of this warranty applies to all electronic assemblies only, and does not include lamps and fuses.

Return Merchandise Authorization

1. You must obtain RMA numbers from American Sammy Corporation *through an authorized ASC distributor*. Please have your serial number available when calling for an RMA number.
2. All items must have an RMA number marked clearly on the outside of the package.
3. Products must be shipped prepaid. Products returned without an RMA number will not be accepted.
4. Credits to accounts are subject to inspection of products for damage and suitability for resale.

F.C.C. Regulation Compliance

This equipment complies with the limits for a Class A digital device pursuant to Part 15 of the F.C.C. Rules when installed as instructed using the F.C.C. shield provided with the "original" kit. These limits are designed to provide reasonable protection against harmful interference when the equipment is operated in a commercial environment. This equipment uses and can radiate radio frequency energy and, if not installed and used in accordance with the instruction manual, may cause harmful interference to radio communications. Operation of this equipment in a residential area is likely to cause harmful interference, in which case the user will be required to correct the interference at his/her own expense.

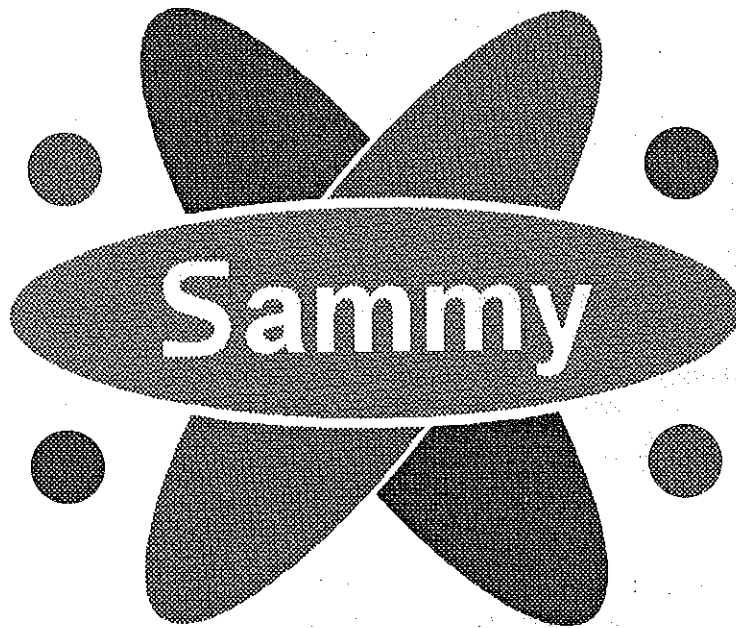

AMERICAN SAMMY CORPORATION

901 Cambridge Drive
Elk Grove Village, IL 60007
Phone: (708) 364-9787
Fax: (708) 364-9831