

DRAGON'S LAIR

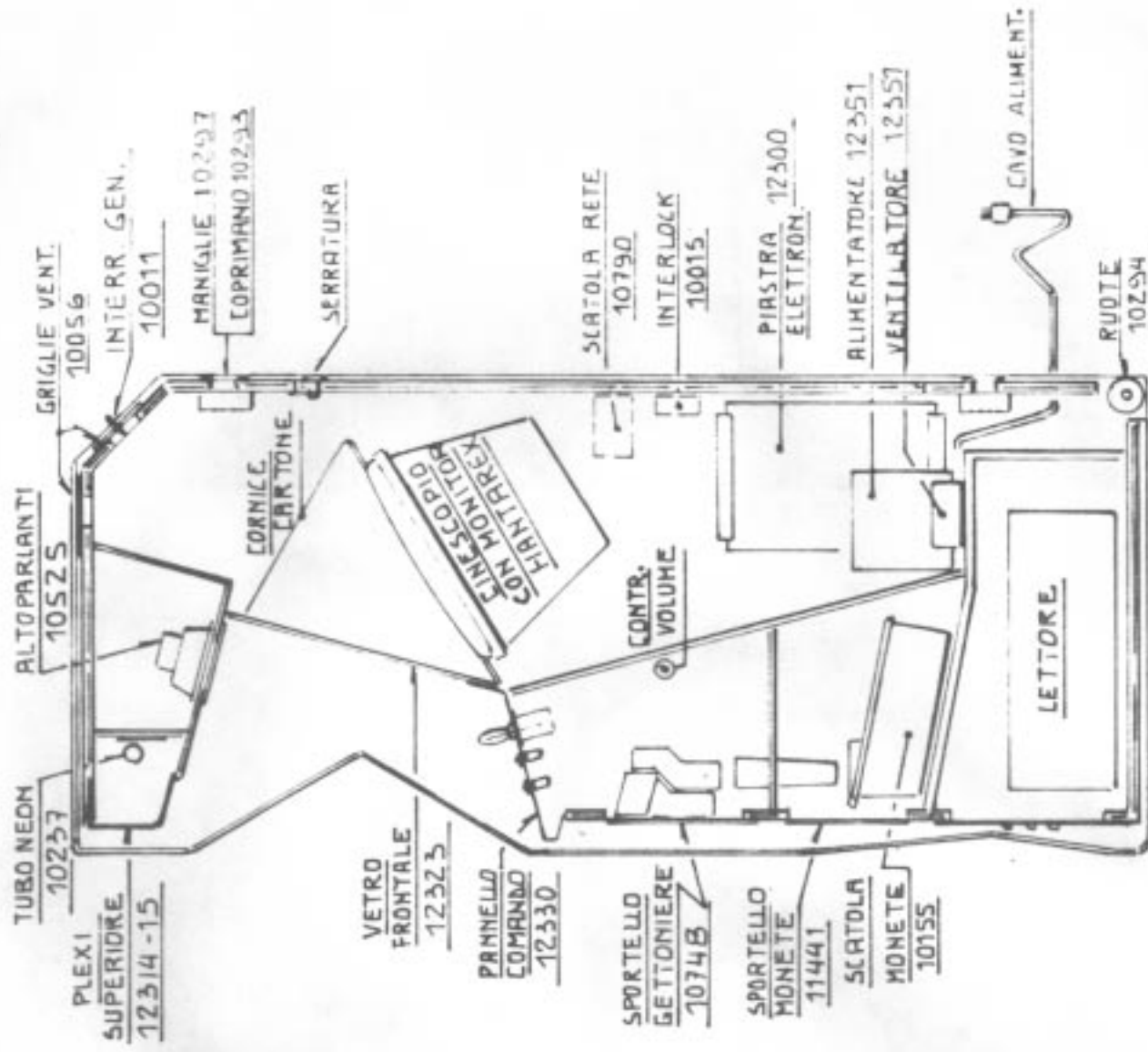

# SPARE PARTS

DIS.	T	DENOMINAZIONE	DIS.	T	DENOMINAZIONE
10011		INTERRITTORE ON-OFF	11050		CABLAGGIO GETTONIERA
10015		INTERLOCK	11058		CABLAGGIO RETE INTERLOCK
10016		MICRO START	11151		BOCCOLA PORTA CUSCINETTO
10025		CONNETTORE BURNDY 3 VIE	11152		ALBERO
10027		CONNETTORE BURNDY 12 VIE	11153		MOZZO CENTRALE
10028		CONNETTORE BURNDY 24 VIE	11154		DISCO COMANDO LAMELLE
10029		CONNETTORE 22 VIE DOPPIE	11156		GUIDA 4 POSIZIONI
10030		CONTATTI BURNDY	11158		CUSCINETTO ASKUBAL Ø16xØ6xH9
10056		RETE ALTOPARLANTE	11160		COMPLESSIVO LEVA 4 POSIZIONI
10059		STAFFA INTERLOCK	11355		INTRODUTTORE MONETA
10060		COPRI INTERLOCK	11356		PIASTRINA INTRODUZIONE MONETA
10081		TILT	11458		PORTALAMPADA GETTONIERA
10132		CONNETTORE 22 VIE SEMPLICI	11462		LAMPADA TUTTO VETRO
10155		SCATOLA MONETA COMPLETA	12305		VENTILATORE
10170		CORPO PULSANTE	12314-15		PLEXI DRAGON'S LAIR
10171		STAFFA PORTA LAMELLE	12317		CARTONCINO CINESCOPIO
10172		BOCCOLA SPESSORE	12323		VETRO BRONZO 565 x 490
10173		PULSANTE SCORREVOLE	12330		COMPLESSIVO PANNELLO COMANDO
10174		PACCO LAMELLE	12335		IMBUTO MODIFICATO
10175		MOLLA PULSANTE	12337		FILTRO PANDA 30
10176		DADO PAL M 16	12339		SPORTELLO CHIUSURA LETTORE LASER
10177		PULSANTE COMPLETO	12348		CONNETTORE 10 VIE SEMPLICI
10237		LAMPADA NEON	12349		TRASFORMATORE
10525		ALTOPARLANTE 8 OHM	12350		PIASTRA ALIMENTATORE LASER
10748		SPORTELLO	12351		ALIMENTATORE COMPLETO
10752		FINESTRA TRASPARENTE			
10753		SCATOLA ILLUMINAZIONE			GETTONIERA G 11
10755		MOLLE RETTANGOLARI			MICROINTERRUTTORE A FILO
10756		COMPLESSIVO ILLUMINAZIONE			
10757		CONTATORE			
10760		PIASTRA BASE J.ST.			
10763		SCODELLINO IMBUTITO			
10767		LAMELLE ELASTICHE SP. 0,8			
10768		STAFFA SUPPORTO LAMELLE			
10772		STRISCIA ISOLANTE			
10780		IMPUGNATURA			
10790		SCATOLA RETE COMPLESSIVO			
10799		CONNETTORE 6 VIE AMP			

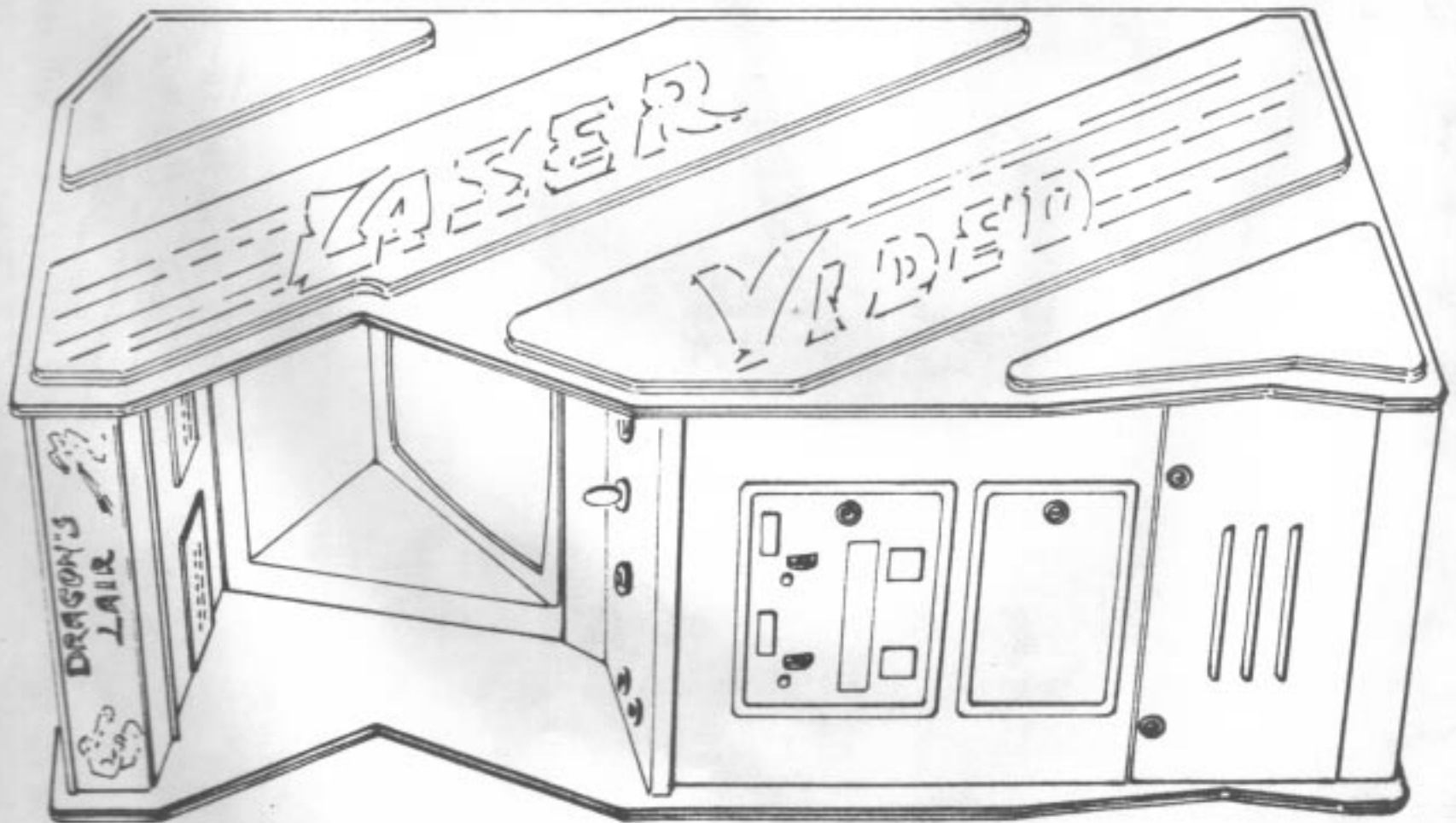

SEZIONE

10749 BIS

COMPLESSIVO SPORTELLO  
A DUE GETTONIERE  
10748

NOTA  
NELLA RICHIESTA DI RICAMBI  
INDICARE IL VALORE DELLA  
MONETA

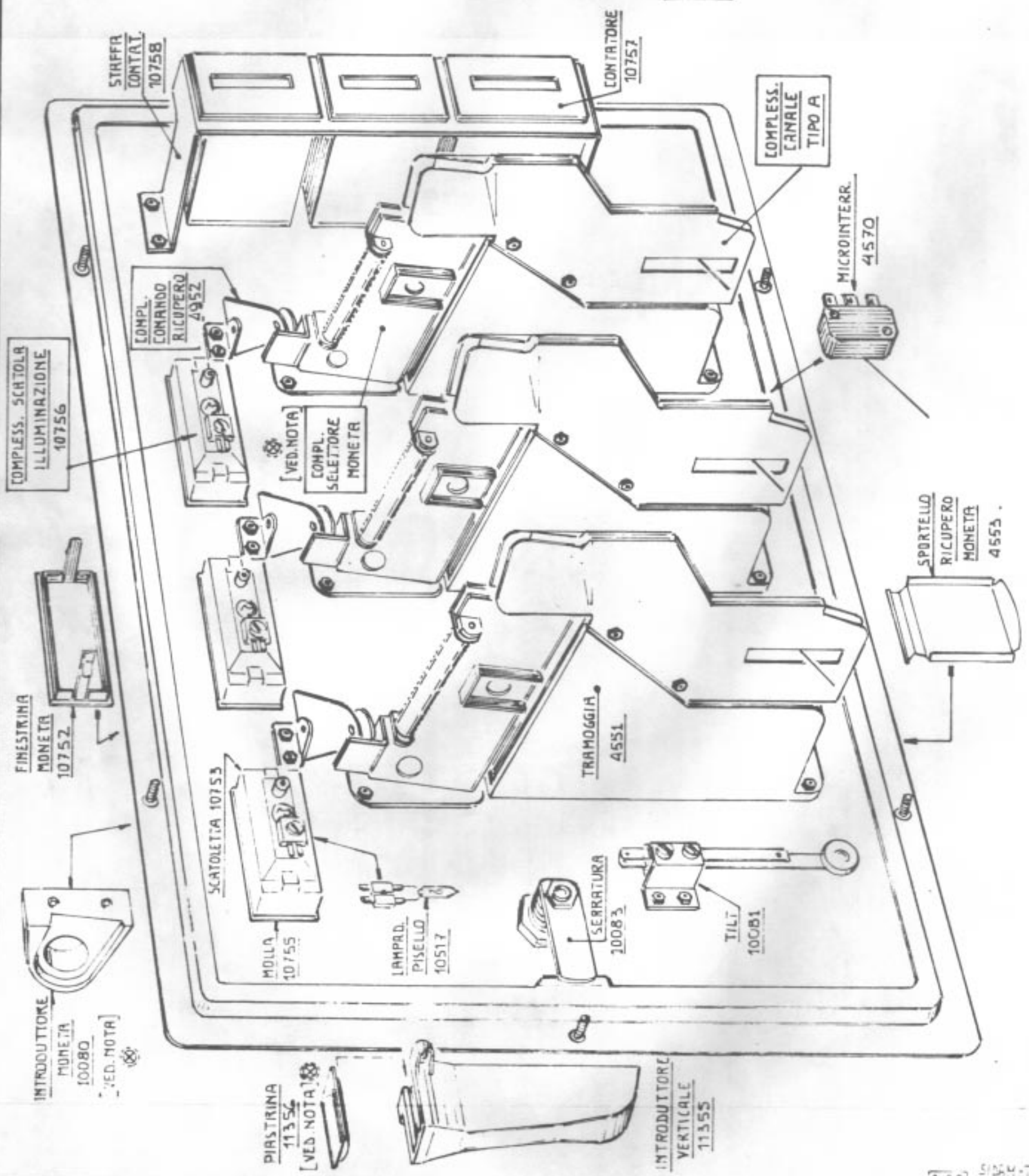
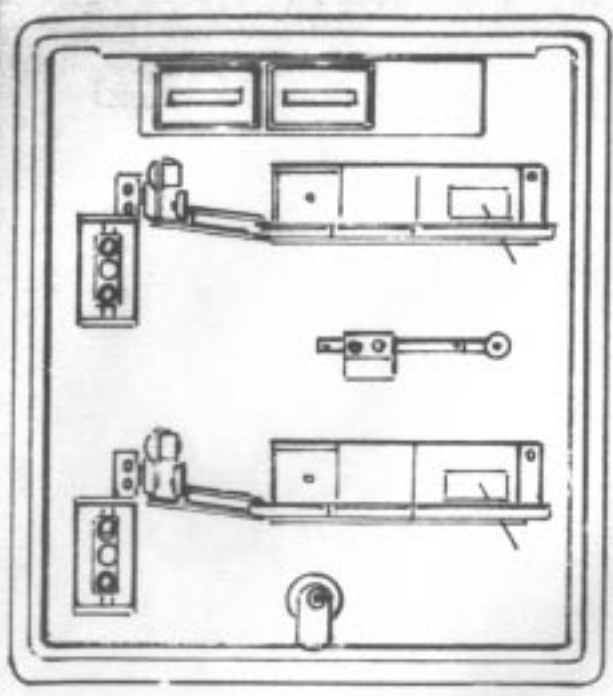

DRAGON'S LAIR

PANNELLO COMANDO

12330

CERNIERA  
11333

PANNELLO  
11331

PORTACENERE  
11350

STAFFA  
11070 BIS

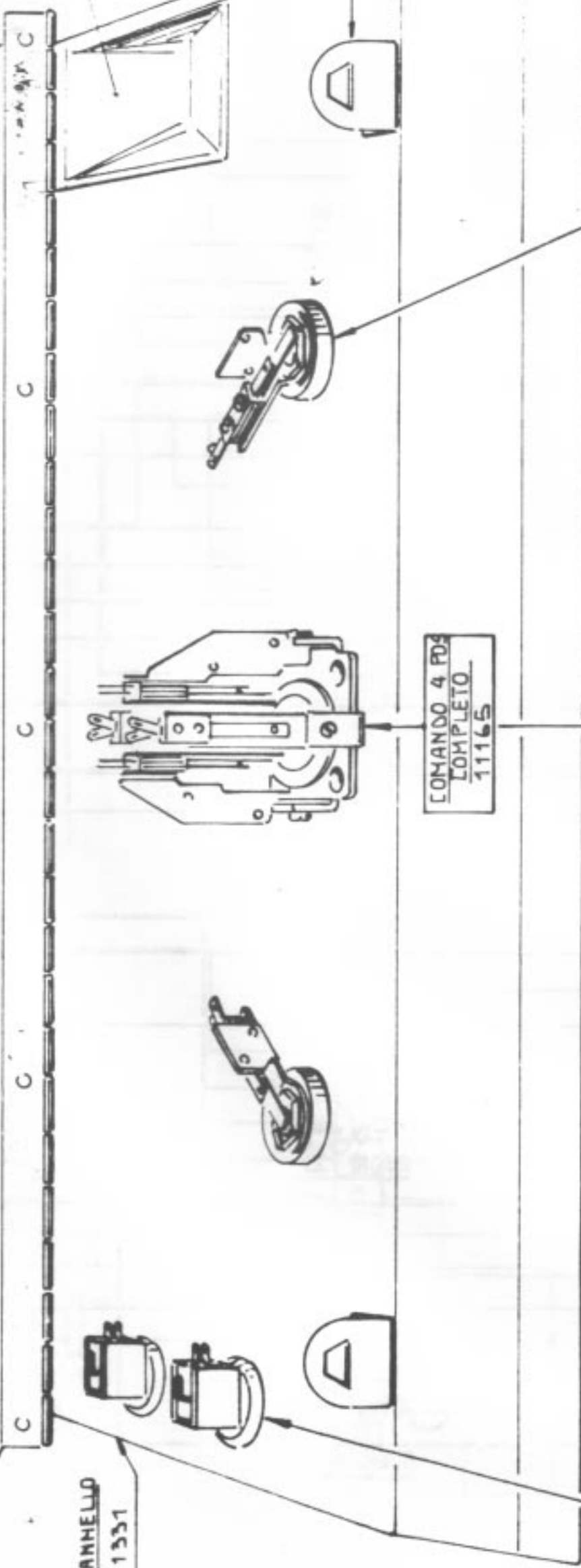

PULSANTE  
COMPLETO  
10152

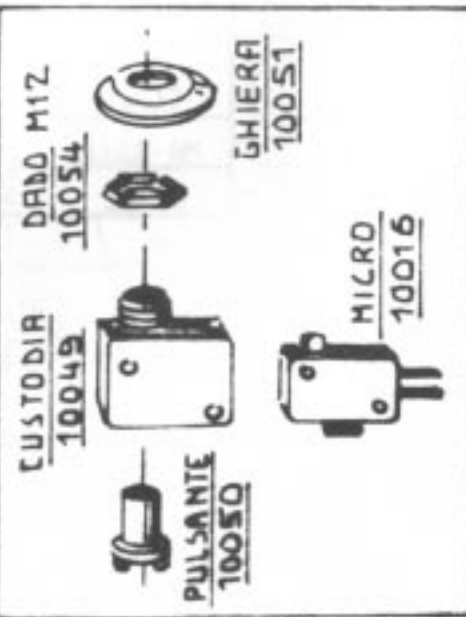

PULSANTE  
COMPLETO  
10177

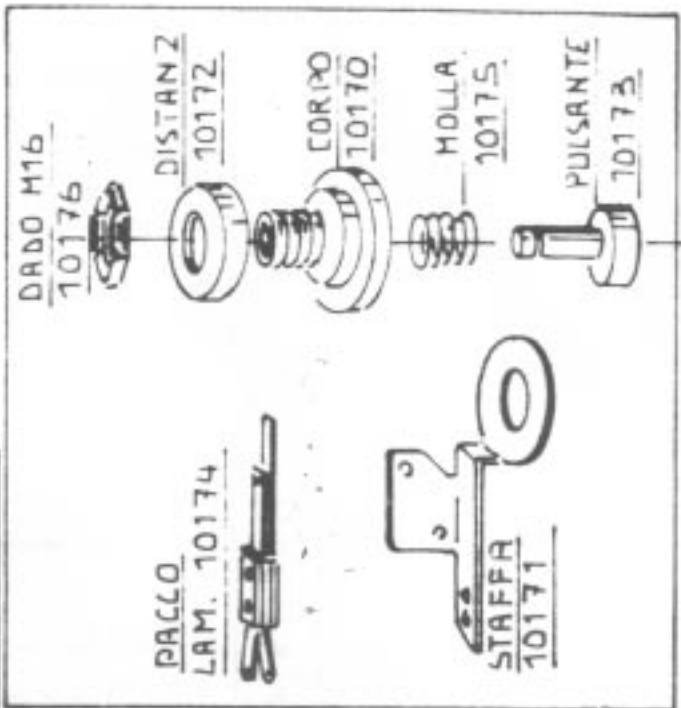

CUSCINETTO  
OSCILLANTE  
11158

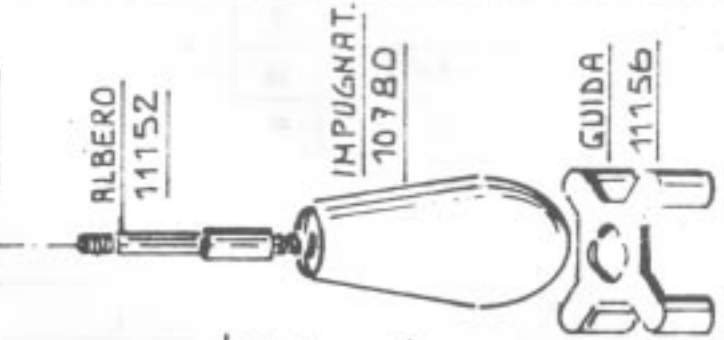

DISCO  
11154

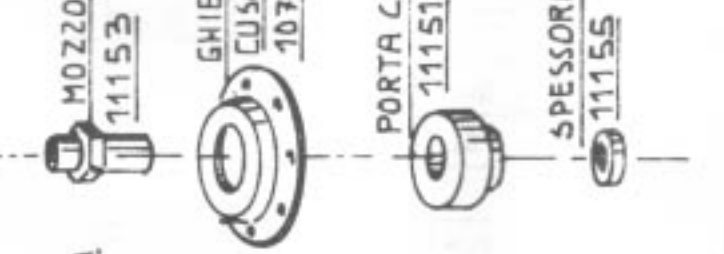

ISOLANTE  
10772



STAFFA  
100768

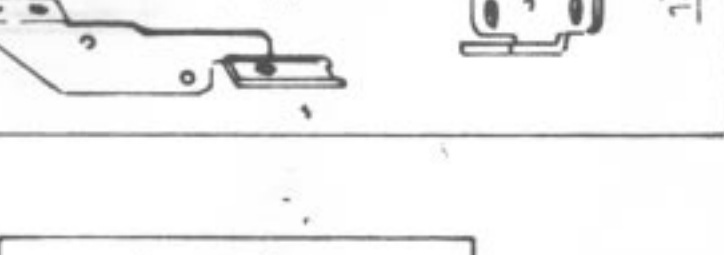

COMANDO 4 POS.  
COMPLETO  
11165

CUSCINETTO  
OSCILLANTE  
11158

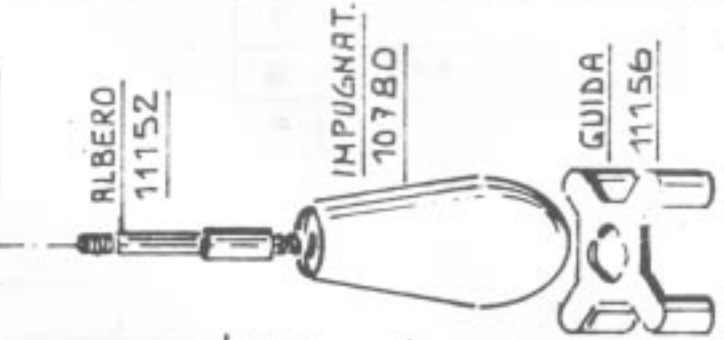

DISCO  
11154

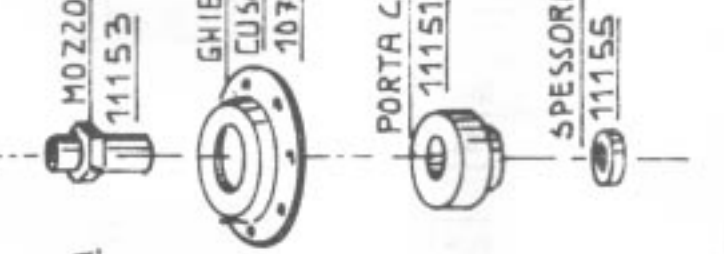

ISOLANTE  
10772



STAFFA  
100768

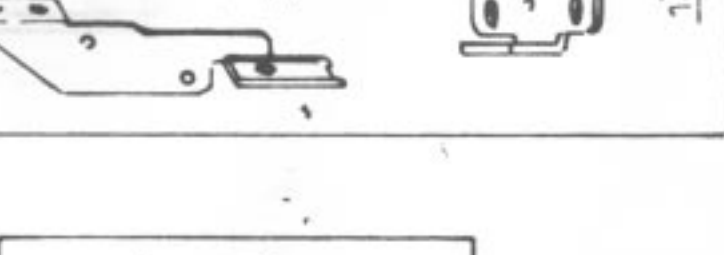

PRESA  
ALIMENTAT.

PRESA COMANDI  
VIDEO DISCO

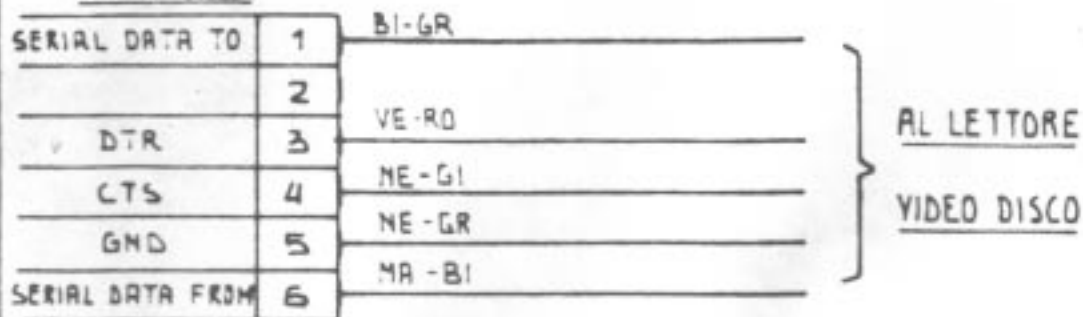

PRESA SCHEDA

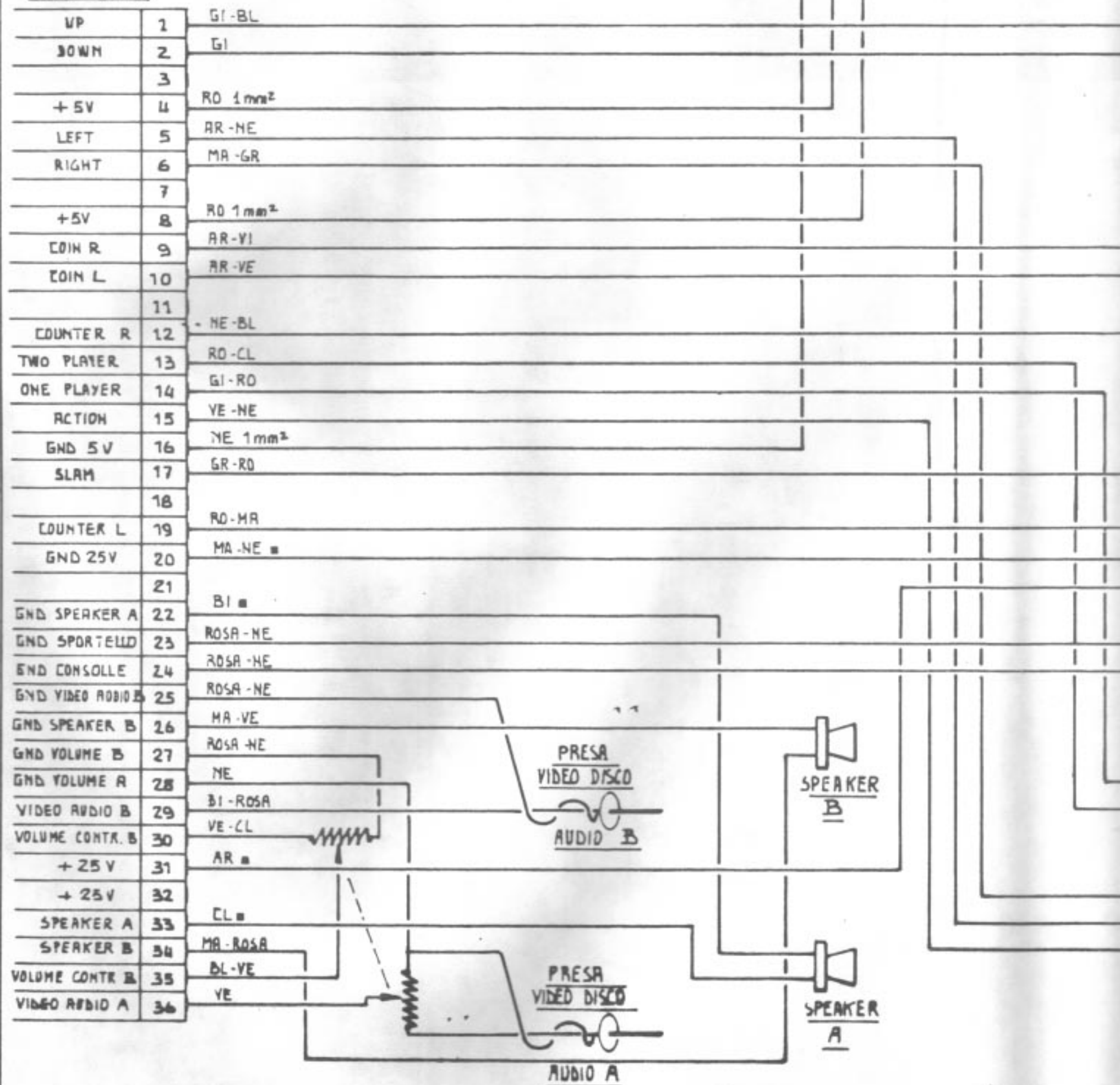

DRAGON'S LAIR

CABLAGGIO GENERALE

13	
12	
11	
10	
9	GND 25V
8	+25V UNREG.
7	
6	
5	
4	
3	0.5V ~ NET.
2	
1	6.3V ~

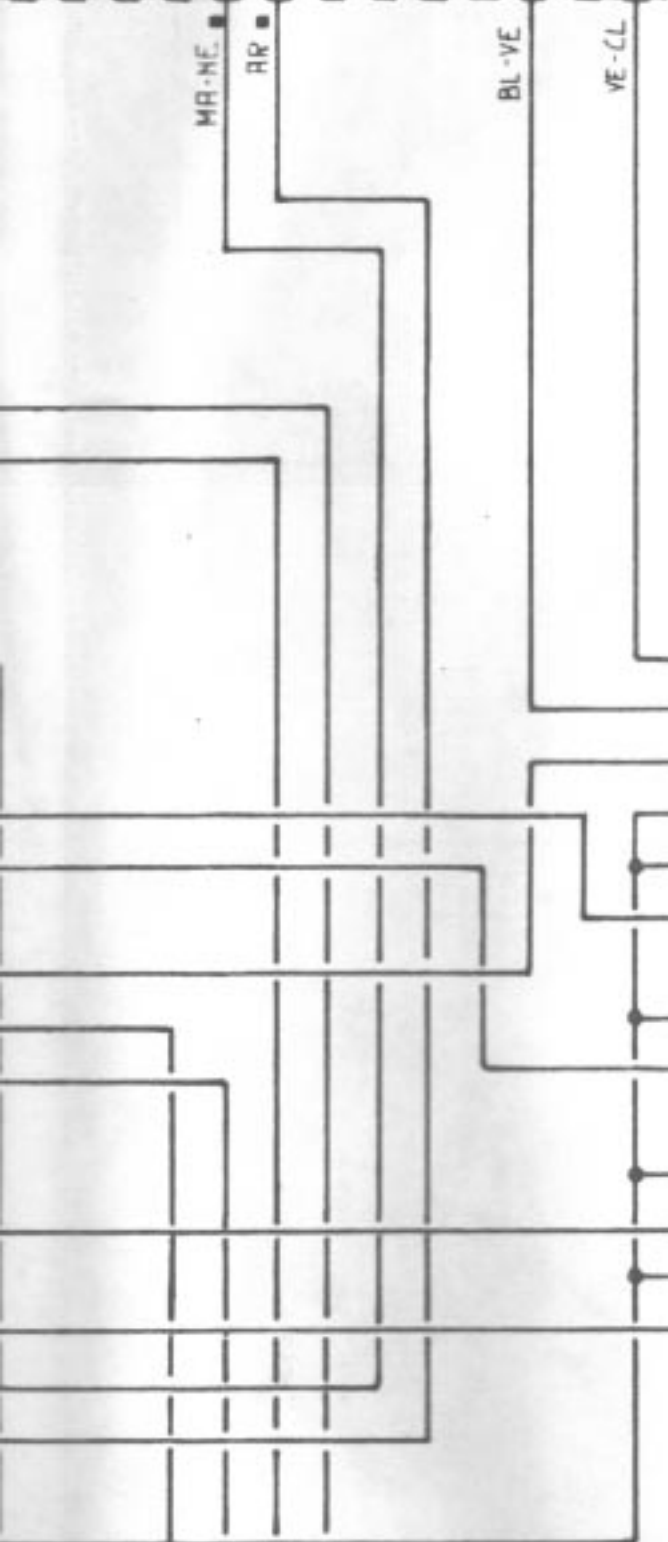

PRESA SPORTELLO

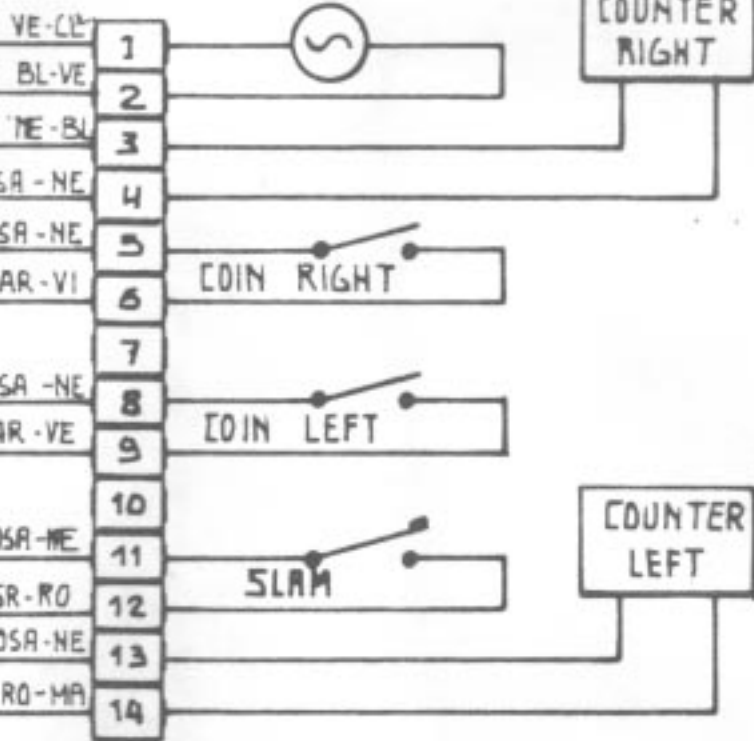

PRESA CONSOLLE

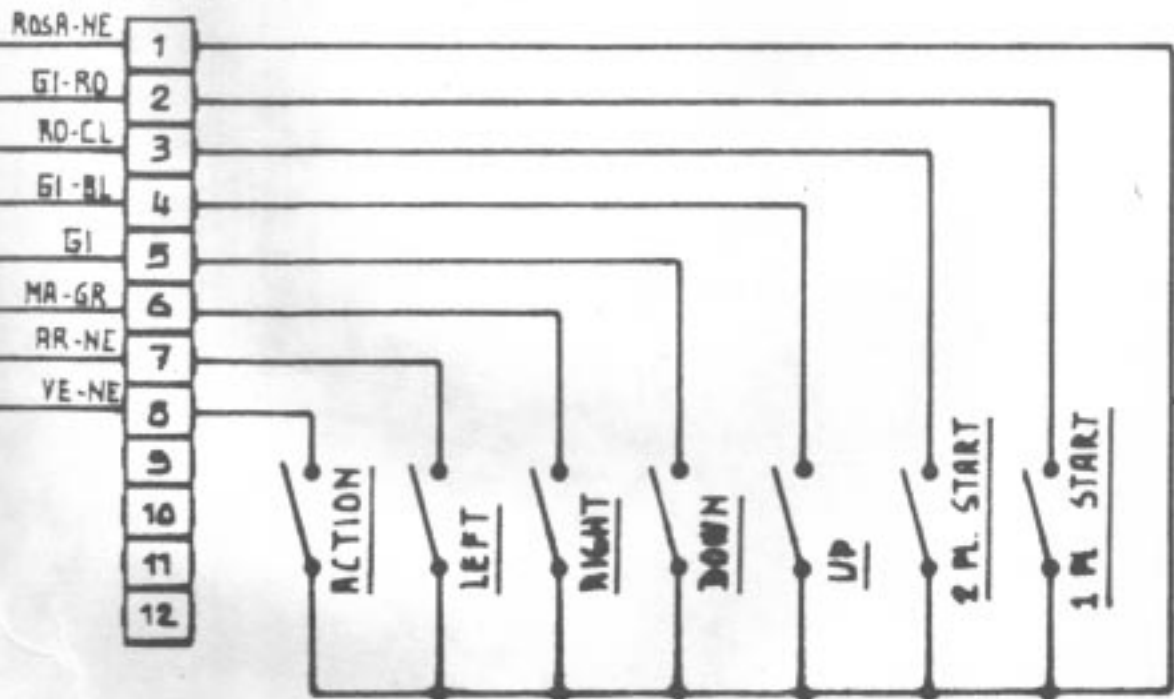

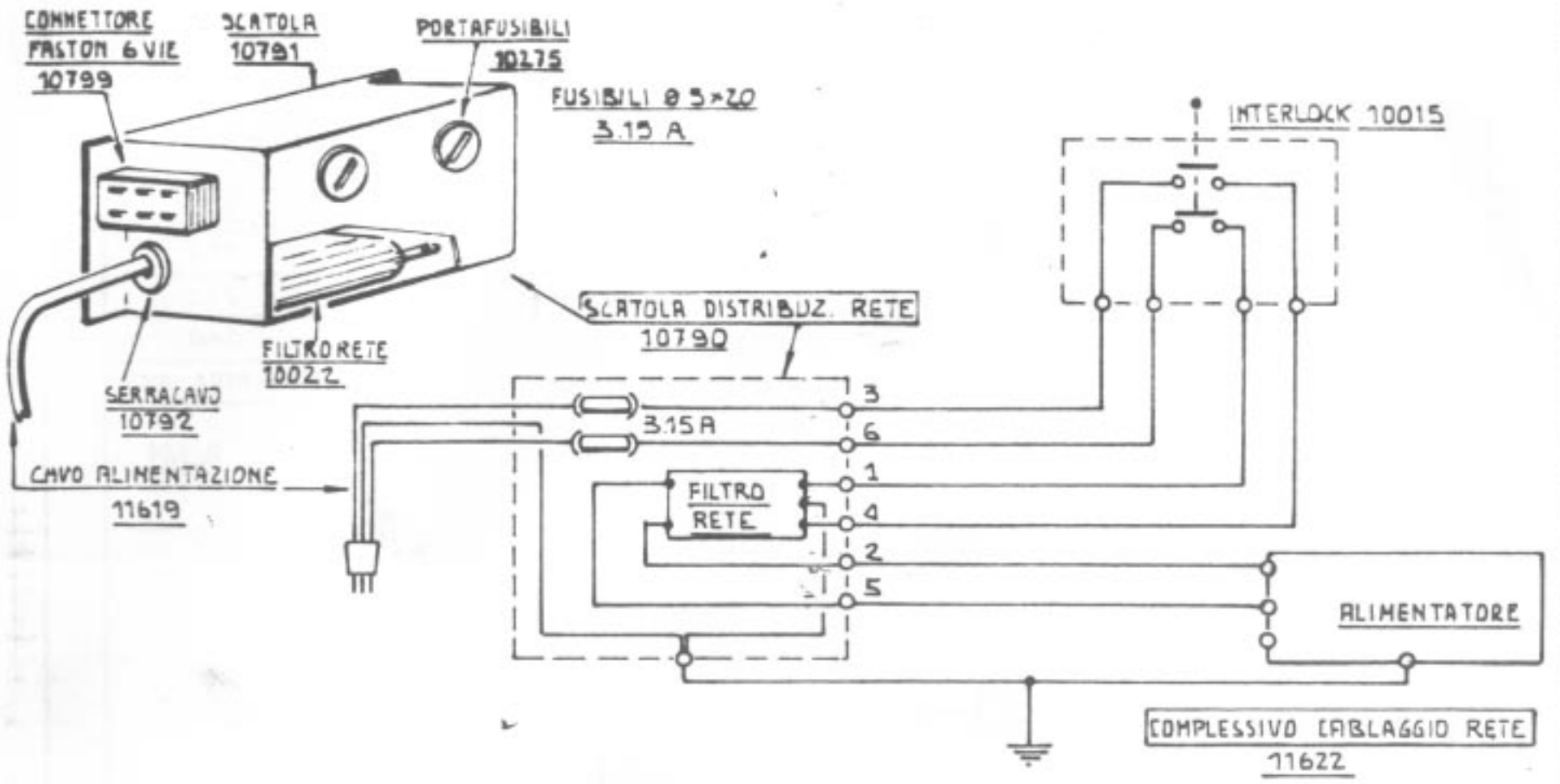

ALIMENTATORE  
12351

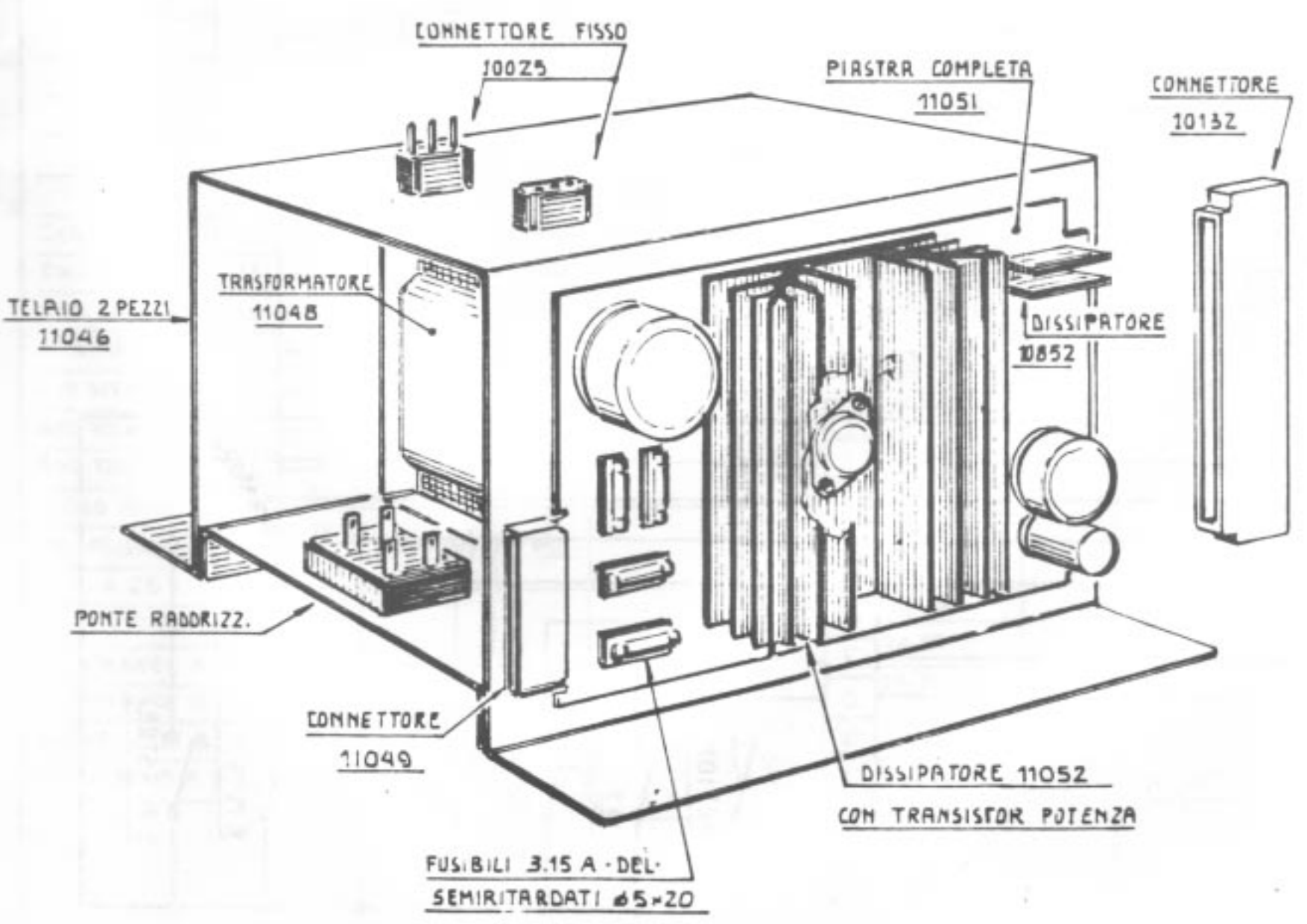



SCHEMA ALIMENTATORE 12351

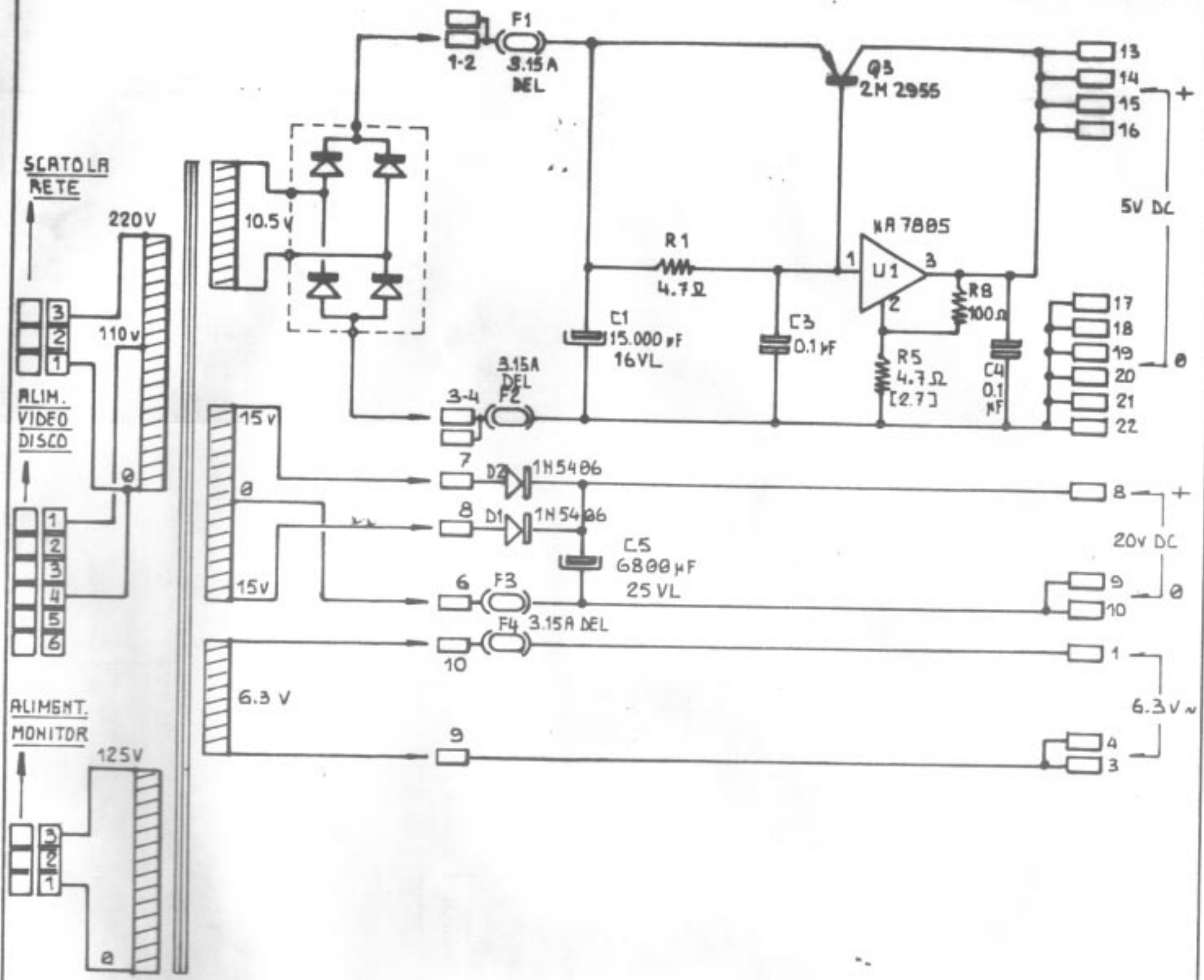

PIASTRA ALIMENTATORE 12350

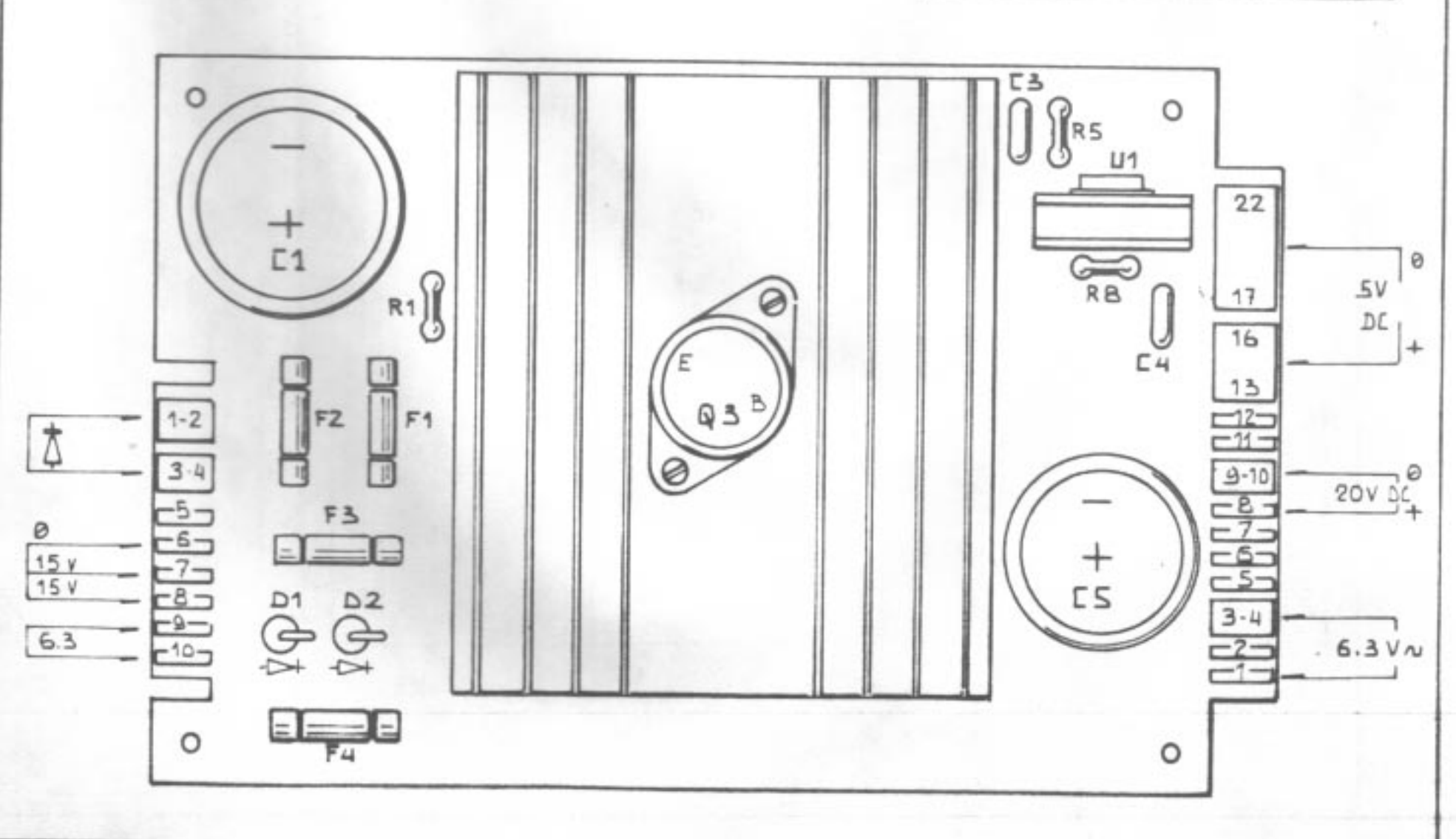

**DRAGON'S LAIR  
PROGRAMMAZIONE  
OPZIONI**

**MONETE GETTONIERA SINISTRA**

**SWA-1 SWA-2 SWA-3**

OFF	OFF	OFF	1 MONETA
ON	OFF	OFF	2 MONETE
OFF	ON	OFF	3 "
ON	ON	OFF	4 "
OFF	OFF	ON	5 "
ON	OFF	ON	6 "
OFF	ON	ON	7 "
ON	ON	ON	8 "

**PARTITE GETTONIERA SINISTRA**

**SWA-4 SWA-5**

OFF	OFF	1 PARTITA
ON	OFF	2 PARTITE
OFF	ON	3 "
ON	ON	4 "

**AUDIO IN ATTRACT**

**SWA-6**

OFF	DISINSERITO
ON	INSERITO

**LIVELLO DIFFICOLTÀ**

**SWA-7 SWA-8**

OFF	OFF	FACILE
ON	OFF	INTERMEDIO
OFF	ON	DIFFICILE
ON	ON	DIFFICILISSIMO

**SW-A**

OFF-ON

OFF-ON

**SW-B**

OFF-ON

OFF-ON

**MONETE GETTONIERA DESTRA**

**SWB-1 SWB-2**

OFF	OFF	1 MONETA
ON	OFF	2 MONETE
OFF	ON	3 "
ON	ON	4 "

**CREDITI GETTONIERA DESTRA**

**SWB-3 SWB-4**

OFF	OFF	1 PARTITA
ON	OFF	2 PARTITE
OFF	ON	3 "
ON	ON	4 "

**LIVES PER PARTITA**

**SWB-5 SWB-6**

OFF	OFF	2 LIVES
ON	OFF	3 "
OFF	ON	4 "
ON	ON	5 "

**SWB-7**

NON USATO

**SWB-8**

DEVE ESSERE SEMPRE " ON "

