



# **Megatouch FORCE Radion™ Coin Box Retrofit**

Visit the Merit Industries, Inc. Web site  
<http://www.meritind.com>



merit industries, inc.

PM0358-03

## Megatouch FORCE Radion Coin Box Retrofit

### CONTENTS:

QTY	PART NUMBER	DESCRIPTION
1	MW0566-XX	OVERSIZED RADION COINBOX
1	HW8401-02	FLAT HANDLE PULL
1	SA0404-01	3" SPEAKER/BRACKET
<b>FOR KITS WITH COINBOX PARTS INCLUDED</b>		
1	EC9796-01	BILL ACCEPTOR
1	HW8733-05	KD LOCK, 7/8L
4	HW3150	6 - 32 KEPNUT
1	MW510-01	CAM, COINBOX LOCK
1	SA0314-01	STACKER HARNESS W/LOCKOUT
2	HW4393	8 - 32 x 1/2I PAN/PHL SEM SCREW
1	HW8811	TIE WRAP

### Removing the Fan

- Turn off the game and disconnect it from its power source.
- Unlock and open the right side door (if you are facing the game) and the rear door, then remove the coin box.
- Remove the screw securing the strain relief cord to the rear door. Be careful not to damage the door while the strain relief cord is disconnected.
- Remove the modem bracket or coin guard from the game if you have either installed.
- Disconnect the motherboard power connector from the motherboard (see Figure 1 for connector location). If you have a cable clamp securing the motherboard power connector, remove the screw from the cable clamp before disconnecting the connector.
- Disconnect the line cord from the power supply, unscrew the thumbnut securing the power supply to the game (see Figure 2) and remove the power supply. Disconnect other harnesses and connectors as needed, but be sure to remember how they were connected.
- Disconnect the harness running to the fan located behind the power supply (see Figure 2), then unscrew the thumbnut fastening the fan to the game and remove the fan. The fan will not be replaced.

### Installing the New Speaker

- Install the supplied speaker assembly in the space where the fan assembly was located and secure it with the thumbnut.
- In the coin box area, disconnect the speaker wire from the audio amp board. See Figures 3 and 4.
- Remove the (2) screws fastening the existing speaker to the game and remove the speaker. The speaker will not be replaced. See Figure 3 for location.
- Route the wire from the new speaker so it does not interfere with the coin path or the operation of the new coin box, then connect it to the audio amp board (see Figure 4).

12. Reconnect the line cord to the power supply, then reinstall the power supply in the game and fasten it with the thumbnut.
13. Reconnect the motherboard power connector and if your game had a cable clamp securing the power connector, replace the screw fastening the clamp. Also reconnect any other harnesses or connectors that were disconnected prior to removing the power supply.
14. Replace the modem bracket or coin guard if you had either installed.
15. Replace the screw securing the strain relief cord to the rear door and close and lock the door.
16. If you have the pre-assembled coin box (with the bill acceptor, lock, pull handle and harness already installed) reconnect the power and signal harness to the bill acceptor and skip to step 37.
21. Replace the lock assembly in the new coin box.
22. Insert the supplied flat handle in the new coin box.
23. Install the new coin box in the game.
24. Plug in and turn on the game.
25. Test the coin mech and verify that it is registering credits correctly.
26. Verify that the speaker is functioning properly.
27. Replace the side door.

**Coin Boxes with Bill Acceptors:**

28. In the coin box area, unlock the existing coin box and remove the cover.
29. Disconnect the power and signal harness from the bill acceptor. Be sure to note the orientation of the harness before disconnecting it.

**30. Mars bill acceptors:**

- Remove the bill acceptor cartridge.
- Remove the (4) nuts fastening the bill acceptor assembly to the existing coin box and remove the bill acceptor assembly.
- Replace the bill acceptor assembly in the new coin box and secure it with the (4) nuts.
- Replace the bill acceptor cartridge.

**Smiley bill acceptors:**

- Remove the rivet and screw holding the front of the coin box in place (see Figures 5 and 6), then pull the front of the coin box forward.
- Press the red tab on the bill acceptor, tilt it back, and remove it from the coin box.

**Installing the New Coin Box**

**Coin Boxes without Bill Acceptors:**

(For coin boxes with bill acceptors, skip to step 28.)

17. Remove the (2) nuts fastening the coin box alignment bracket (MW0538-01) to the existing coin box and remove the bracket. See Figure 8.
18. Replace the coin box alignment bracket in the new coin box and secure it with the (2) screws.
19. Unlock the existing coin box and remove the coin box cover.
20. Remove the lock assembly from the existing coin box (be sure to note the orientation). The lock assembly is held in place with a screw and a 7/8" nut.

- Replace the bill acceptor in the new coin box and secure it with a rivet and screw.
- 31. Remove the (2) screws fastening the metrimate connector (see Figure 7) to the coin box and remove the connector and harness. Be sure to note the orientation of the connector before removing it.
- 32. Replace the metrimate connector and harness in the new coin box and secure it with the (2) screws.
- 33. Reconnect the power and signal harness to the bill acceptor.
- 34. Remove the lock assembly from the existing coin box (be sure to note the orientation). The lock assembly is held in place with a screw and a 7/8" nut.
- 35. Replace the lock assembly in the new coin box.
- 36. Insert the supplied flat handle in the new coin box.
- 37. Install the new coin box in the game.
- 38. Plug in and turn on the game.
- 39. Test the bill acceptor and verify that it is registering credits correctly.
- 40. Verify that the speaker is functioning properly.
- 41. Replace the side door.

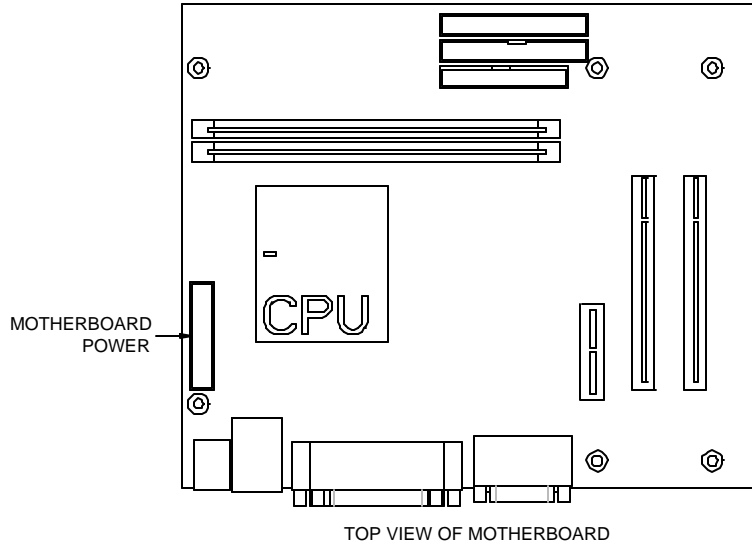

FIGURE 1 - MOTHERBOARD POWER CONNECTOR LOCATION

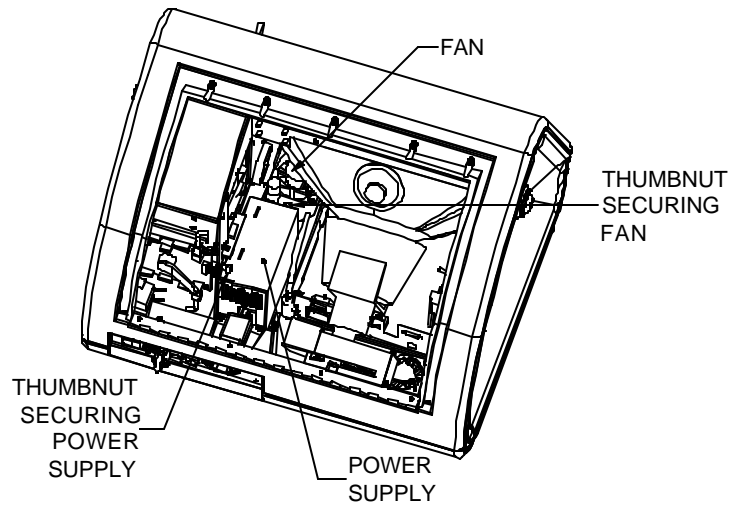

FIGURE 2 - POWER SUPPLY/FAN LOCATIONS

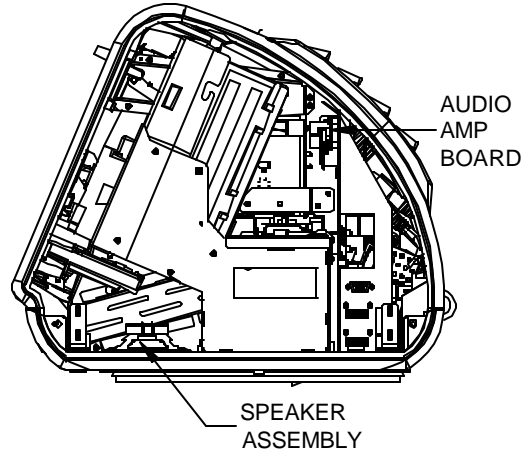

FIGURE 3 - LOCATION OF EXISTING SPEAKER ASSEMBLY/AUDIO AMP BOARD

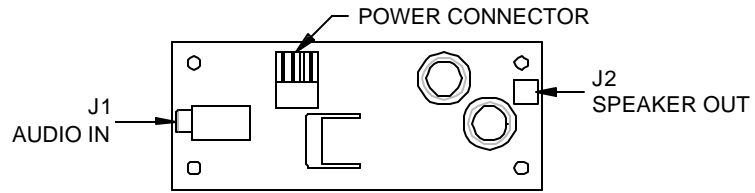

FIGURE 4 - AUDIO AMP BOARD DRAWING

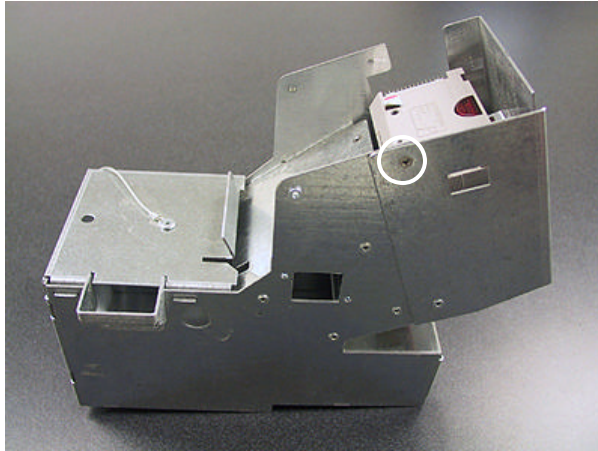

FIGURE 5 - LOCATION OF SCREW HOLDING FRONT OF COIN BOX IN PLACE (SMILEY BILL ACCEPTOR ONLY)

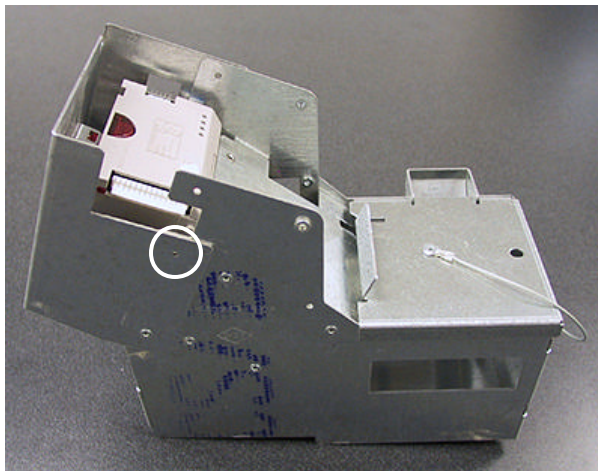
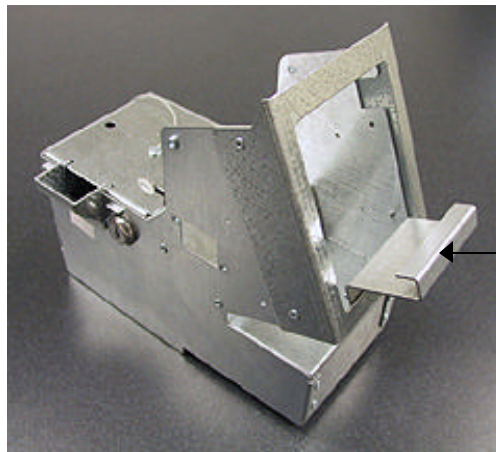

FIGURE 6 - LOCATION OF RIVET HOLDING FRONT OF COIN BOX IN PLACE (SMILEY BILL ACCEPTOR ONLY)



FIGURE 7 - METRIMATE CONNECTOR



COIN BOX  
ALIGNMENT  
BRACKET

FIGURE 8 - LOCATION OF COIN BOX ALIGNMENT BRACKET





MEGATOUCH FORCE RADION COIN BOX RETROFIT  
PM0358-03