

ANDROS

CASTLE™

Service Manual

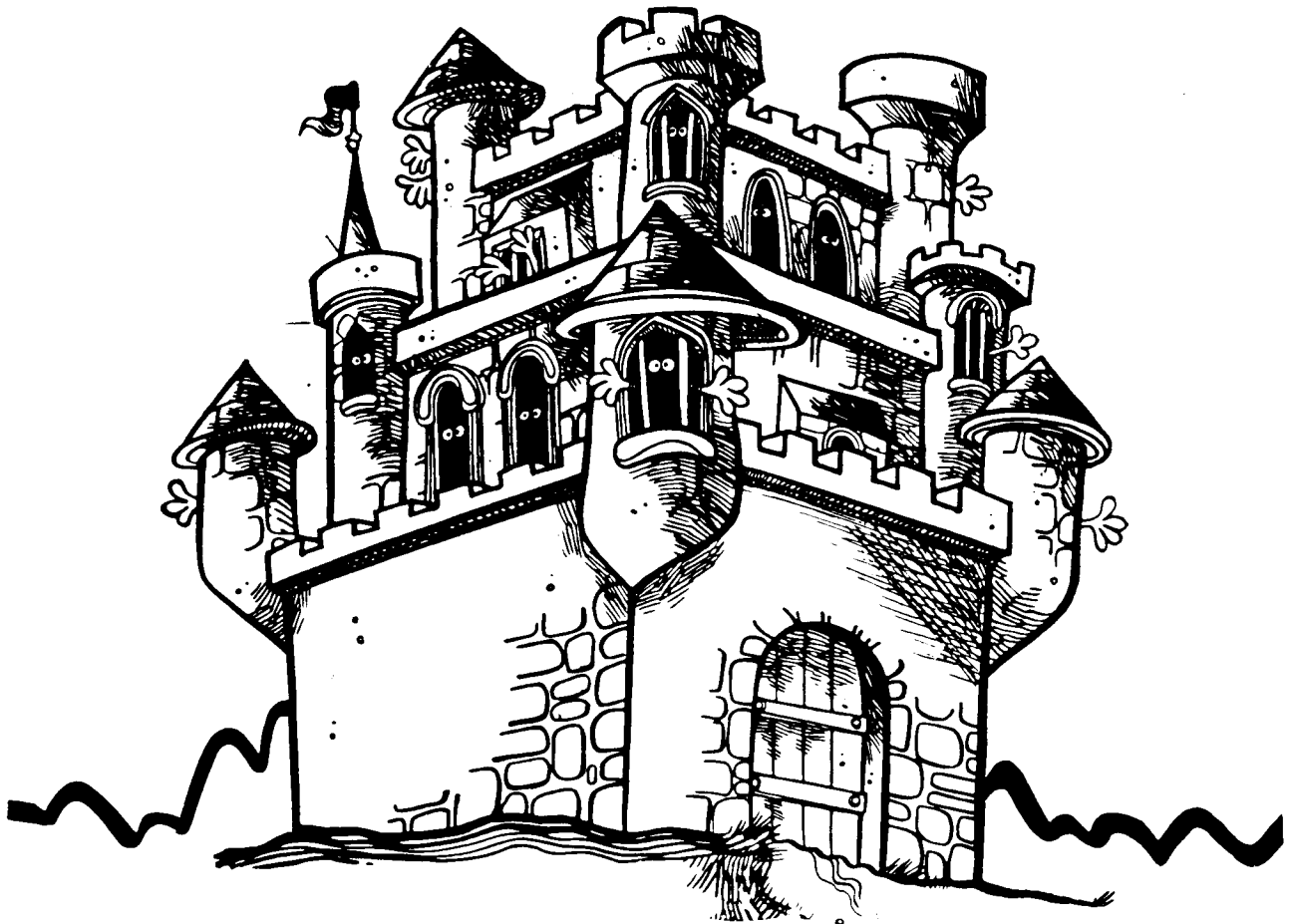

UNIVERSAL®

WARNING:

THIS EQUIPMENT GENERATES AND USES RADIO FREQUENCY ENERGY AND IF NOT INSTALLED AND USED PROPERLY, I.E., IN STRICT ACCORDANCE WITH THE INSTRUCTIONS MANUAL, MAY CAUSE HARMFUL INTERFERENCE TO RADIO COMMUNICATIONS. IT HAS BEEN TESTED AND FOUND TO COMPLY WITH THE LIMITS FOR A CLASS A COMPUTING DEVICE PURSUANT TO SUBPART J OF PART 15 OF FCC RULES, WHICH ARE DESIGNED TO PROVIDE REASONABLE PROTECTION AGAINST SUCH INTERFERENCE WHEN OPERATED IN A COMMERCIAL ENVIRONMENT.

OPERATION OF THIS EQUIPMENT IN A RESIDENTIAL AREA IS LIKELY TO CAUSE INTERFERENCE IN WHICH CASE THE USER AT HIS OWN EXPENSE WILL BE REQUIRED TO TAKE WHATEVER MEASURES MAY BE REQUIRED TO CORRECT THE INTERFERENCE.

UNIVERSAL

Thank you for your purchase of *UNIVERSAL'S MR. DO'S CASTLE CONVERSION KIT*.[®] Before attempting installation make certain that your conversion kit is complete.

Your kit includes:

- A. (1) Mr. Do's Castle P.C.B. (contained in a R.F. shield)
- B. (1) Audio Amplifier P.C.B.
- C. (1) License Sticker
- D. (1) Main Harness Assembly
- E. (1) 4-Way Joystick
- F. (4) Push Buttons (complete with housing)
- G. (1) 24" X 9" Clear Control Panel Plexi Glass
- H. (1) set of Control Panel Decals
 - I. (1) Polycarbonate Control Panel Overlay
- J. (1) Mr. Do's Castle Marquis Plexi
- K. (1) set of Mr. Do's Castle Side Decals

Caution:

Installation of conversion kits or any other such modification to any coin operated video game should be attempted only by qualified service personel.

CONTENTS

I. How to play	1
II. Various optional settings	2
III. How to conduct self-testing	3-4
IV. Main circuit board IC location and parts list	5-6
V. Wiring diagram (Connector)	7
VI. Main circuit board schematic diagram	8-11
VII. Block diagram	11
Caution I. (to prevent X-ray exposure from the CRT)	12
Caution II. (to prevent interference to radio and TV reception)	12

REFERENCE DRAWINGS

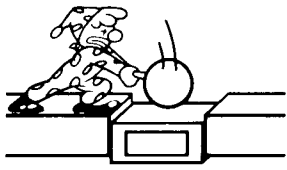
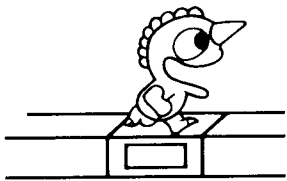
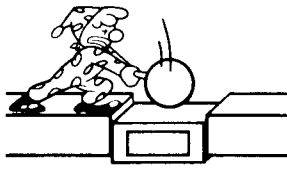
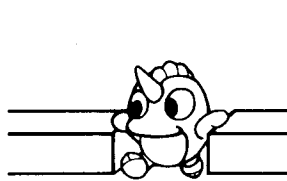





Fig. 1 Main Circuit Board IC Location	5
Fig. 2 Wiring Diagram (Connector)	7
Fig. 3 Main Circuit Board Schematic Diagram (No. 1)	8
Fig. 4 Main Circuit Board Schematic Diagram (No. 2)	9
Fig. 5 Main Circuit Board Schematic Diagram (No. 3)	10
Fig. 6 Main Circuit Board Schematic Diagram (No. 4)	11
Fig. 7 Block Diagram	11

SPECIFICATIONS

TABLE TYPE		UPRIGHT TYPE	
564 m/m (D)	AC100V/115V/230V	800 m/m (D)	AC100V/115V/230V
863 m/m (W)	50/60Hz	640 m/m (W)	50/60Hz
570 - 680 m/m (H)	140W (18")	1750 m/m (H)	180W (20")
▽ 95-2447		▽ 95-1653	

I. HOW TO PLAY

1. Operate Mr. Do! by means of the lever.
2. After dropping a block by use of the hammer, skillfully drop the unicorn into the hole. Then drop the block onto the unicorn and you can exterminate it.
3. You can also exterminate the unicorn by dropping a block onto it while it is walking.
4. You can hit and knock over a unicorn by use of the hammer in scenes 1 and 2.
5. Make good use of the skull blocks, and you can wipe out several unicorn at a time. When dropping both skull blocks, the blocks between them will also drop at the same time.
6. Only Mr. Do! can remove the ladder.
7. If Mr. Do! has been trapped between two unicorns on the blocks, you can help him escape by dropping a block with the hammer.
8. When three of the key blocks have been dropped, the door on the top level will open and a shield will appear. If you wipe it out the unicorns will change to EXTRA.
9. You can exterminate EXTRA by hammering it or dropping Mr. Do! on it. When it has been wiped out, a flag will be run up on the pole.
10. Another Mr. Do! will appear if you succeed in running up five flags, E X T R A on the pole.
11. The last unicorn in scenes 1 and 2, will change and split into the blue unicorns after 20 seconds – after a further 25 seconds, the blue unicorns will split into double unicorns, and then after another 5 seconds these will become eight – there will be no further increase.
12. Red unicorns will become green if Mr. Do! hits them four times with the hammer, and green unicorns will become blue when he hits them once with it.

ASSAULTING		SCORE	
<p>When walking</p>  <p style="text-align: center;">↓</p> 	<p>When in the hole</p>  <p style="text-align: center;">↓</p> 	 500~ 2,500 pts	 20 pts
		 1,000~ 5,000 pts	 1,500~ 8,000 pts
		 1,500~ 7,500 pts	 500~ 2,500 pts

II. VARIOUS OPTIONAL SETTINGS

DESCRIPTIONS OF DIP SWITCHES

- Dip Switch A

1. Number of Mr. Do! Given (SW1, 2)

No. of Mr. Do!	SW1	SW2
3	OFF	OFF
4	OFF	ON
5	ON	OFF
2	ON	ON

2. Game Style (SW3)

Style	SW3
Table	OFF
Upright	ON

3. Difficulty of EXTRA (SW4)

Difficulty	SW4
Easy	OFF
Difficult	ON

4. SW5 is not used.

5. Automatic Renewal of Screen (SW6)

Automatic renewal	SW6
Made	OFF
Not made	ON

6. Difficulty of the Games (SW7, 8)

Difficulty	SW7	SW8
1 (Beginner)	OFF	OFF
2	OFF	ON
3	ON	OFF
4 (Advanced)	ON	ON

- Positions of Dip Switches

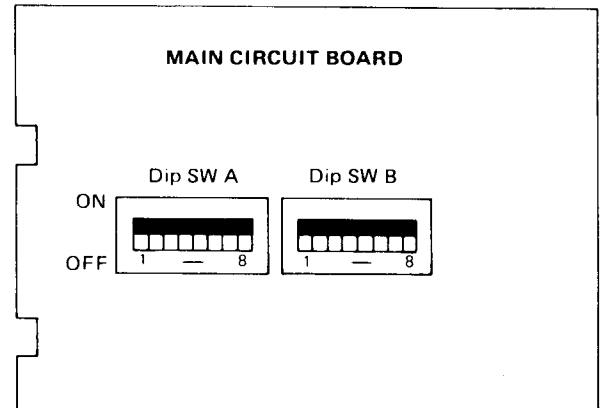

- Dip Switch B (Coin & Credit)

Coin	Credit	Left-side chute				Right-side chute			
		SW1	SW2	SW3	SW4	SW5	SW6	SW7	SW8
1	1	OFF	OFF	OFF	OFF	OFF	OFF	OFF	OFF
1	2	OFF	OFF	OFF	ON	OFF	OFF	OFF	ON
1	3	OFF	OFF	ON	OFF	OFF	OFF	ON	OFF
1	4	OFF	OFF	ON	ON	OFF	OFF	ON	ON
1	5	OFF	ON	OFF	OFF	OFF	ON	OFF	OFF
2	1	OFF	ON	OFF	ON	OFF	ON	OFF	ON
2	3	OFF	ON	ON	OFF	OFF	ON	ON	OFF
3	1	OFF	ON	ON	ON	OFF	ON	ON	ON
3	2	ON	OFF	OFF	OFF	ON	OFF	OFF	OFF
4	1	ON	OFF	OFF	ON	ON	OFF	OFF	ON
1	1	ON	OFF	ON	OFF	ON	OFF	ON	OFF
1	1	ON	OFF	ON	ON	ON	OFF	ON	ON
1	1	ON	ON	OFF	OFF	ON	ON	OFF	OFF
1	1	ON	ON	OFF	ON	ON	ON	OFF	ON
1	1	ON	ON	ON	OFF	ON	ON	ON	OFF
Free play		ON	ON	ON	ON	ON	ON	ON	ON

Standard and Custom Price Settings

The game price set by a combination of dip SWs is displayed on the monitor when coin credit is 0.

- When the settings for right and left chutes are the same, "1 coin – 1 credit", "2 coins – 3 credits", etc. are displayed.
- When the settings for right and left chutes are provided differently, their respective contents can be displayed.

III. HOW TO CONDUCT SELF-TESTING

★ This machine has a self-testor which locates any abnormalities with the machine should they occur.

[Self-Testing Procedure]

Turn power ON while pressing the push-button or either the 1st or the 2nd player side, and self-testing will follow automatically.

[Self-Testing Items]

(1) RAM Test:

When normal — “RAM OK” will appear on the screen, and the test will proceed to the next step.
 When abnormal — “RAM ” will appear, and the test will be suspended.

↓
Abnormal RAM No.

(2) ROM Test:

When normal — “ROM OK” will appear on the screen, and the test will proceed to the next step.
 When abnormal — “ROM . ” will appear, and the test will be suspended.

↓
Abnormal ROM data
↓
Abnormal ROM No.

(3) Sound OFF:

“SOUND OFF” will appear on the screen, and the sound that has been made to that time will stop, then, the test will proceed to the next step. The machine is out of order if the sound does not stop or the test does not proceed to the next step.

(4) Switch Test:

Switch names are displayed on the left side of the screen, while input conditions will be displayed on the right side. When the switch is ON, “0” is displayed for input, and when it is OFF, “1” is displayed. Conduct test while turning each switch ON-OFF — the test will advance to the next step after a minute.

Switch name	Input condition
2P DOWN	1
LEFT	1
UP	0
RIGHT	1
1P DOWN	1
LEFT	1
UP	1
RIGHT	1
2P START	1
NOT USED	1
2P JUMP	1
FIRE	1
1P START	1
NOT USED	1
1P JUMP	1
FIRE	1
NOT USED	1
NOT USED	1

Switch name	Input condition
COIN LEFT	1
COIN RIGHT	1
PAUSE	1
SERVICE	1
TEST	1
TILT	1

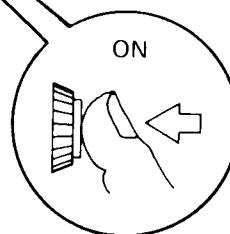

“0” will appear when pushing the pushbutton on the 1st player’s side.

UNIVERSAL

Dip switch A	1	0	1	1	0	1	1	1
" B	1	1	1	1	1	1	1	0

(5) TV Monitor Test:

Cross hatch pattern will appear on the entire screen. Monitor adjustment can be done by means of the pattern.

- Self-testing will stop at this point. Turn ON power again when you want to resume game or execute self-test again.
- * In case you have found any abnormality as a result of the self-test, contact the dealer who sold the machine to you.

IV. MAIN CIRCUIT BOARD IC LOCATION AND PARTS LIST

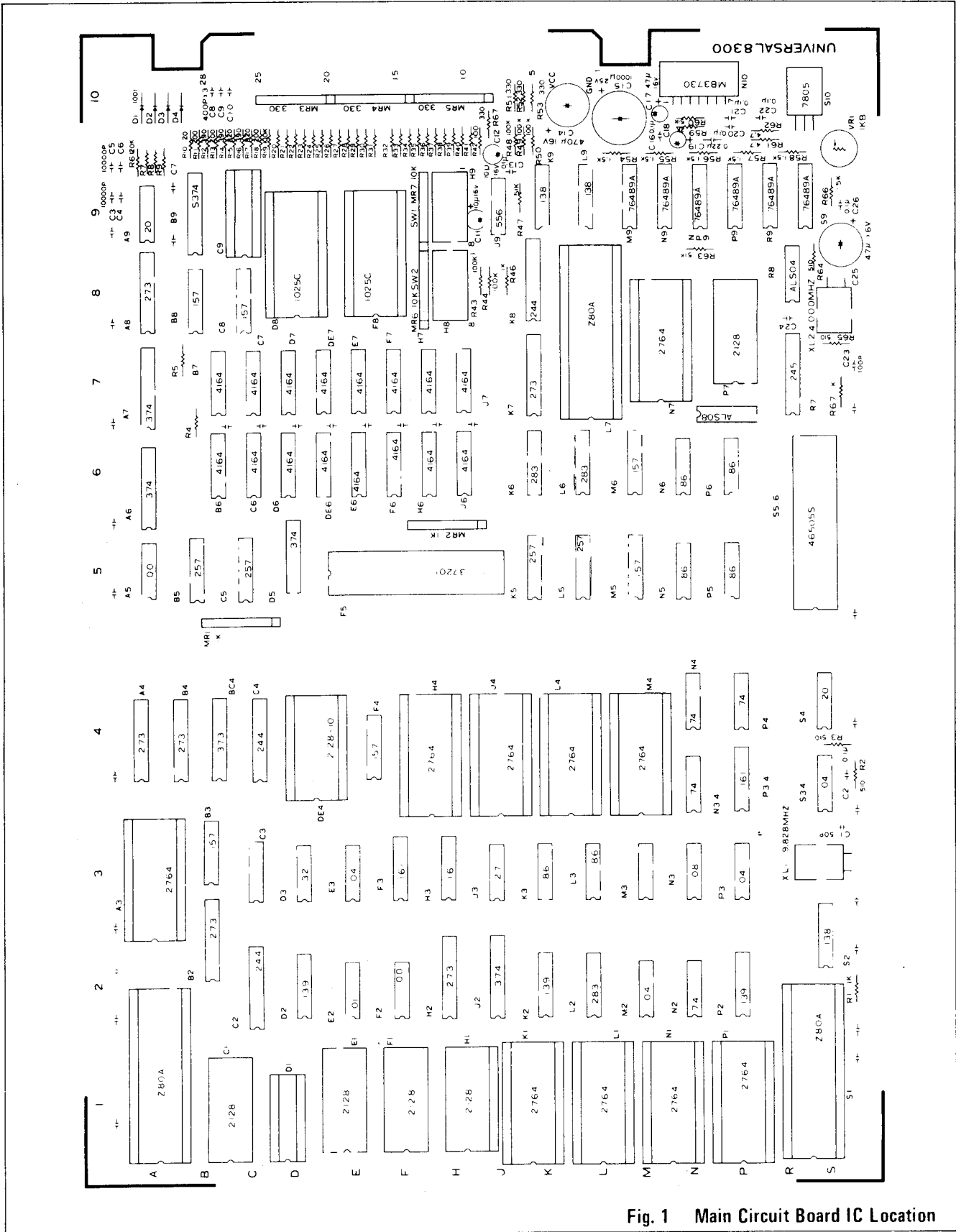

Fig. 1 Main Circuit Board IC Location

[1] Integrated Circuit

Item No.	Q'ty	Description
74LS 00N	2	TTL
74LS 01	1	"
74LS 04	4	"
74LS 08	1	"
74LS 20	2	"
74LS 27	1	"
74LS 32	1	"
74LS 74	5	"
74LS 86	7	"
74LS138	3	"
74LS139	3	"
74LS157	6	"
74LS161	3	"
74LS244	3	"
74LS245	1	"
74LS257	4	"
74LS273	6	"
74LS283	3	"
74LS373	1	"
74LS374	4	"
74ALS04N	1	"
74ALS08	1	"
74S374N	1	"
Z80A	3	NMOS CPU (4MHz)
2764-300	8	NMOS 64K bits EP ROM (Access 300nsec)
27128-300	2	NMOS 128K bits ROM (Access 300 nsec)
N82S147	2	4096 bits Fuse ROM
TMS4164-200	16	64K DRAM
MB8128-150	5	NMOS 16K bits Static RAM (Access 150nsec)
MB8128-100	1	NMOS 16K bits Static RAM (Access 100nsec)
CF37201N	1	Custom Function
NE556	1	Timer
MB3730	1	Audio Amplifier
SN76489AN	4	Programable Sound Generator
TMS1025N2CL	2	CMOS
HD46505SP	1	CRTC
10D1	4	Diode
UA7805	1	Regulator

This drawing provides standard information. Universal reserves the right to change without notice.

[2] Capacitors

Rating	Q'ty	Description
0.1 μ F16V	22	Ceramic Capacitor
0.1 μ F25V	3	"
0.001 μ F25V	4	"
400PF50V	3	"
100PF50V	1	"
50PF50V	1	"
47 μ F16V	1	"
10 μ F16V	2	"
22 μ F16V	1	"
47 μ F16V	1	"
470 μ F6.3V	1	"
0.22 μ F16V	1	ES Capacitor
1000 μ F16V	1	"

[3] Resistors

Rating	Q'ty	Description
4.7 Ω	2	Carbon Solid
20 Ω	1	"
100 Ω	1	"
200 Ω	3	"
330 Ω	4	"
390 Ω	3	"
510 Ω	4	"
820 Ω	2	"
1K Ω	3	"
1.5K Ω	4	"
2K Ω	1	"
22K Ω	1	"
5.1K Ω	1	"
100 Ω	28	"
120 Ω	4	"
51 Ω	1	"
330 x 8	3	Resistor Array
1K x 8	2	"
10K x 8	2	"
1K Ω B	1	"

[4] Misc

Name	Q'ty	Description
Dip SW	2	8 Elements Switch Array
X tal	1	9.828MHz
"	1	4.000MHz
20P	2	IC Socket
28P	10	"

V. WIRING DIAGRAM (CONNECTOR)

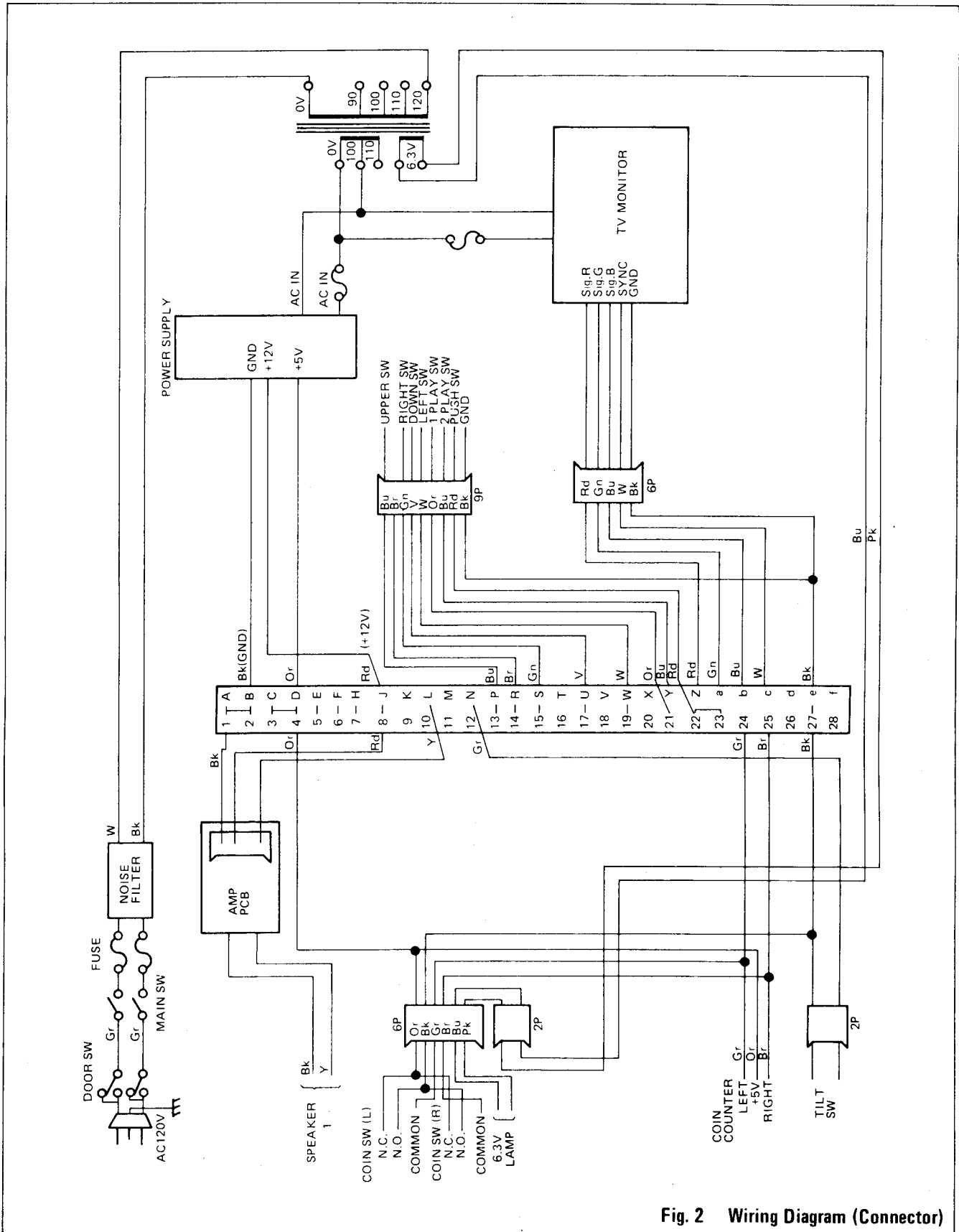
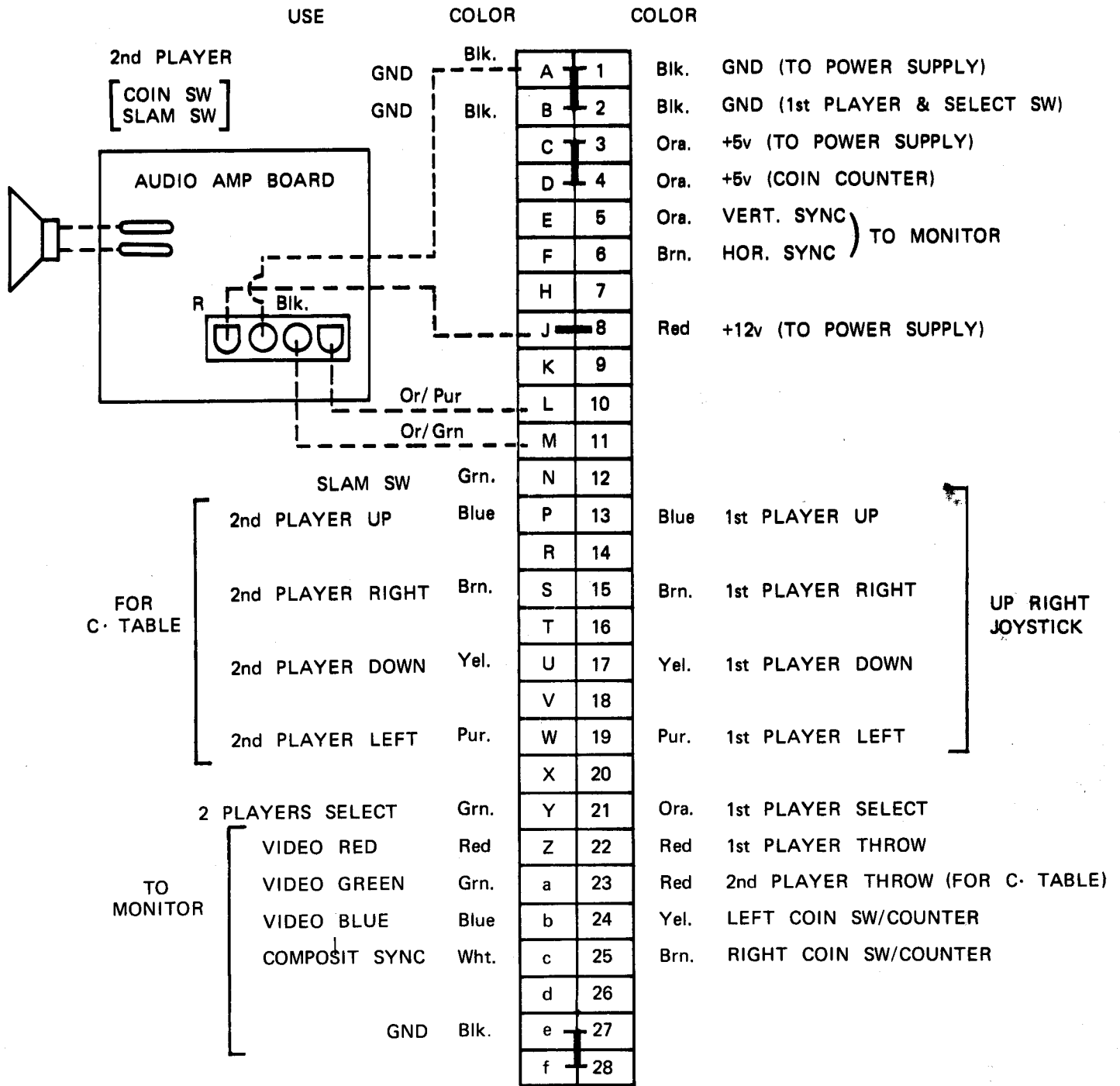

Fig. 2 Wiring Diagram (Connector)

MR. DO'S CASTLE HARNESS PIN ASSIGNMENT

SOLDER SIDE

COMPONENT SIDE



NOTE:

CONNECTION FOR USE WITH COIN METER

CONNECTION FOR USE WITHOUT COIN METER

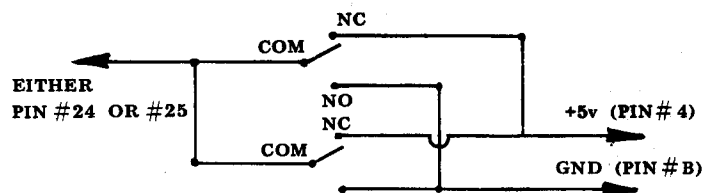
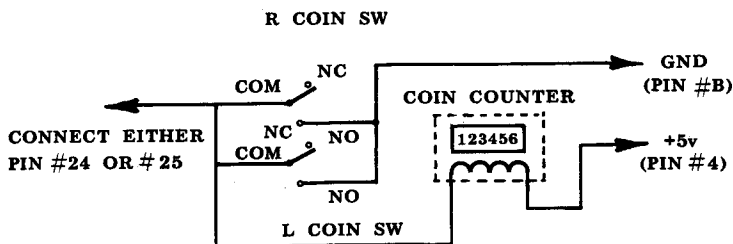

MODIFICATION FOR POSITIVE HORIZONTAL AND VERTICAL OUTPUT

MR. DO'S CASTLE P.C.B.

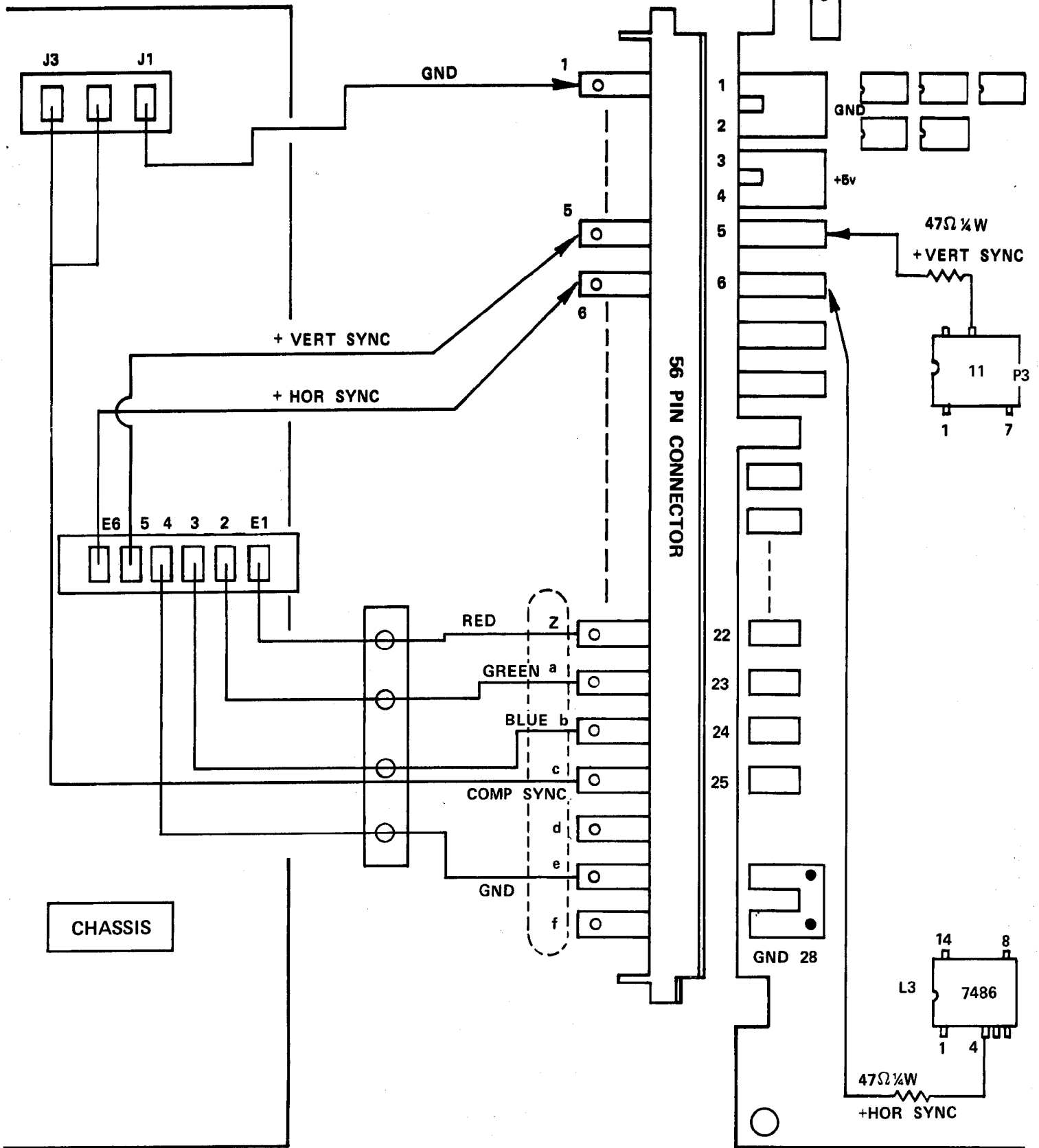

* BE SURE TO REMOVE COMP SYNC LINE WHEN INSTALLING THE POSITIVE INDEPENDANT SYNC LINES.

NOTE: IN MOST CASES WHERE BY A SEPERATE HORIZONTAL AND VERTICAL NEGATIVE SYNC. PULSE IS NEEDED, THE COMPOSIT SYNC. SIGNAL CAN BE USED BY CONNECTING THE WHITE WIRE (PIN C) TO BOTH NEGATIVE HORIZONTAL AND VERTICAL INPUTS ON THE MONITOR CHASSIS.

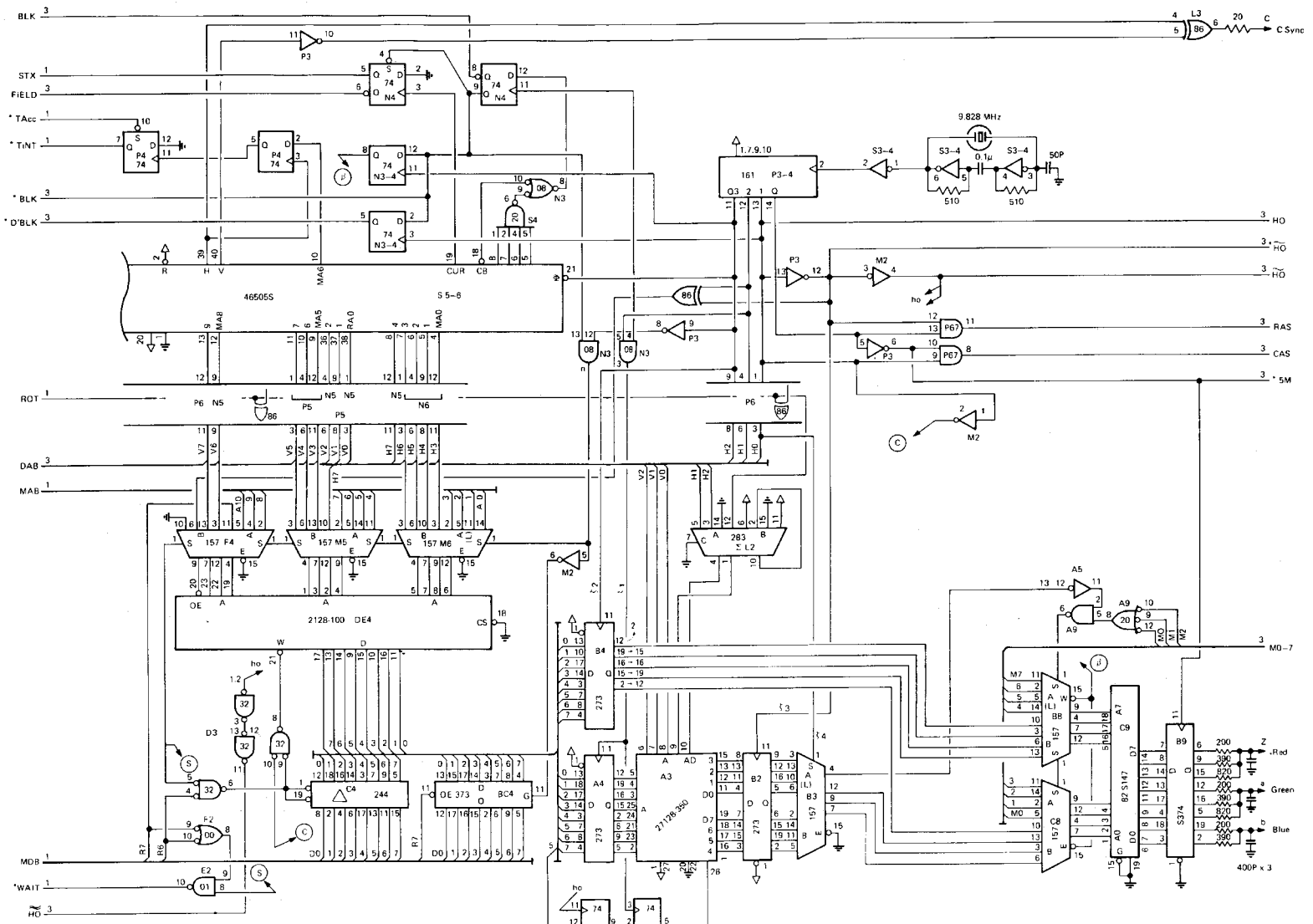

Fig. 4 Main Circuit Board Schematic Diagram (No. 2)

Mr. Do's CASTLE
8302

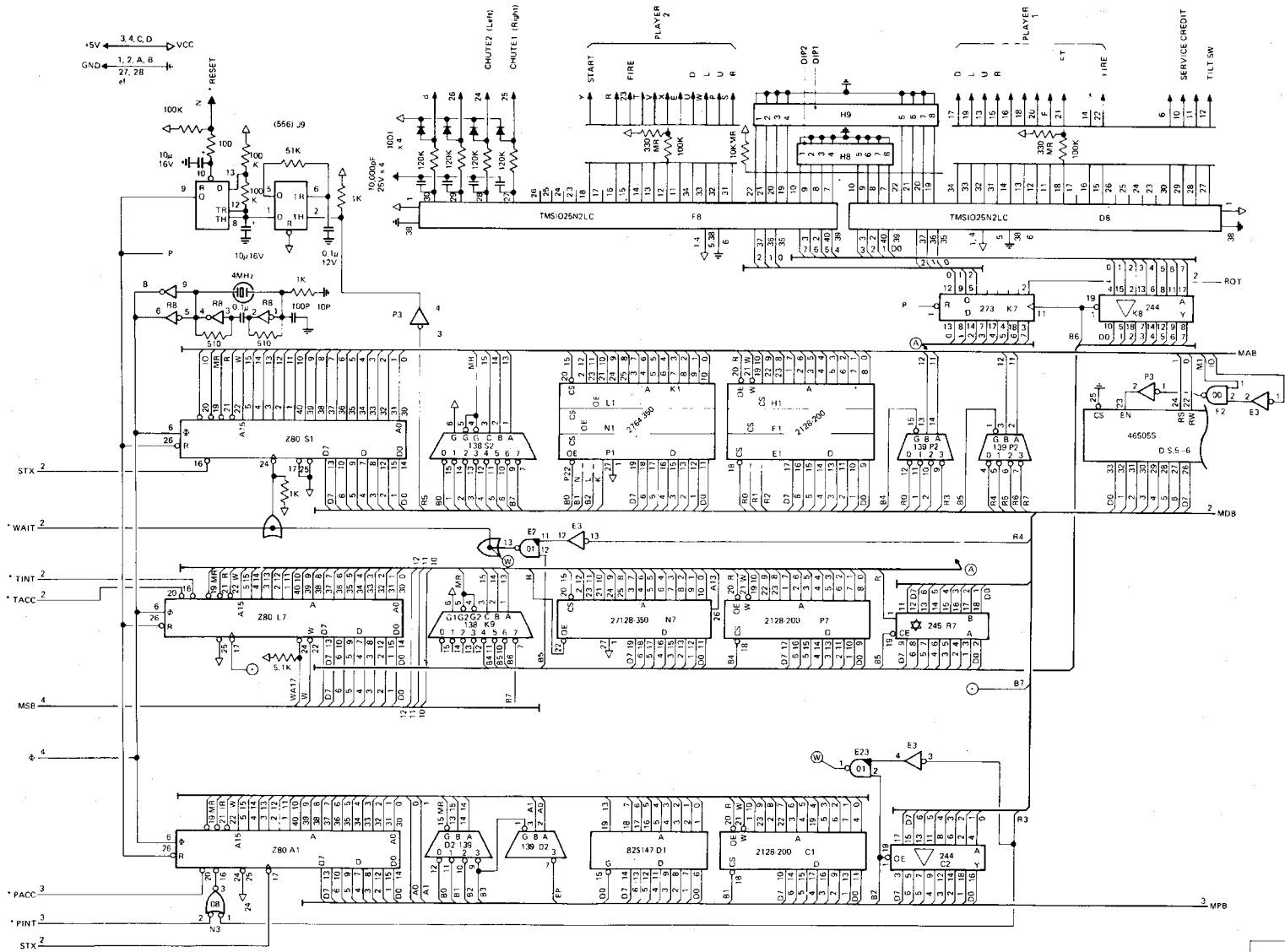

Fig. 5 Main Circuit Board Schematic Diagram (No. 3)

Mr. Do's CASTLE
8302



CASTLE

COPYRIGHT INFRINGEMENT POLICY

Universal USA Inc., holds the sole proprietary interest for the manufacture of the Mr. Do's Castle video game, and has registered a copyright and trademark with the United States Copyright Office.

Due to Mr. Do's Castle's excellent earnings report, there may be those interested in illegally reproducing this game.

LET THERE BE NO MISTAKE! Universal USA Inc., will protect its proprietary rights by taking any and all legal action necessary against any person or company that manufactures, sells, distributes, and/or operates any game which violates these exclusive rights of the Mr. Do's Castle video game. Any violation whatsoever will be prosecuted to the fullest extent of the law.

Authenticity of any Mr. Do's Castle game can be verified by calling 1-(800) 538-7538 during regular business hours.



Universal U.S.A., Inc.
3250 Victor Street
(408) 727-4591 Santa Clara, CA 95050 TELEX: 172247

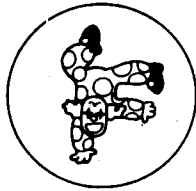

Head Office:

Universal Co., Ltd.

1-7-7, Nihonbashi Horidome-cho, Chuo-ku, Tokyo 103, Japan
Phone: 03-661-6004, 6005 Cable: UNMANIFACT
Telex: J27348 (UNICO)

Universal U.S.A. Inc.

3250 Victor Street, Santa Clara, California 95050, U.S.A.
Phone: 408-727-4591-5 Telex: 172247 (UNI USA SNTA)
Main Line of Business: Development, manufacture, sales, and
export & import of amusement machines

European Office

81 Tottenham Court Road, London W1A 1EY
Phone: 01-631-1713 Telex: 892989.ELCOIN