

420-6990-01  
1ST PRINTING



## SEGA CORPORATION

Nissay Aroma Building, 5-37-1, Kamata, Ohta-ku, Tokyo 144-8721, Japan

Phone: +81-3-5480-6582 Facsimile: +81-3-5480-6584

© SEGA

# Ferrari

OFFICIAL LICENSED PRODUCT

- All trade marks used with permission of the owners.
- AMD, the AMD ARROW Logo and combinations thereof are trademarks of Advanced Micro Devices, Inc.

OUTRUN 2 SPECIAL TOURS SDX SERVICE MANUAL

420-6990-01



## SERVICE MANUAL



### IMPORTANT

- Before using this product, read this manual carefully to understand the contents herein stated.
- After reading this manual, be sure to keep it near the product or in a convenient place for easy reference when necessary.

# TABLE OF CONTENTS

BEFORE USING THE PRODUCT, BE SURE TO READ THE FOLLOWING:

|   |           |
|---|-----------|
| TABLE OF CONTENTS .....                                     | i         |
| INTRODUCTION .....  | ii        |
| <b>1 PRECAUTIONS REGARDING PRODUCT OPERATION .....</b>      | <b>1</b>  |
| 1-1 BEFORE OPERATION .....                                  | 1         |
| 1-2 DURING OPERATION (PAYING ATTENTION TO CUSTOMERS) .....  | 4         |
| 1-3 PRECAUTIONS FOR TICKET OPERATION .....                  | 7         |
| 1-4 SWITCHING OFF THE POWER.....                            | 15        |
| <b>2 GAME DESCRIPTION.....</b>                              | <b>16</b> |
| 2-1 BASIC CONTROLS.....                                     | 17        |
| 2-2 GAME OUTLINE.....                                       | 18        |
| 2-3 SETUP SCREEN ORDER AND CONTENTS.....                    | 19        |
| 2-4 GAME INSTRUCTIONS .....                                 | 30        |
| 2-5 NAME ENTRY AND INTERNET RANKING .....                   | 38        |
| <b>3 EXPLANATION OF TEST AND DATA DISPLAY .....</b>         | <b>40</b> |
| 3-1 SWITCH UNIT AND COIN METER .....                        | 42        |
| 3-2 SYSTEM TEST MODE .....                                  | 43        |
| 3-3 GAME TEST MODE .....                                    | 44        |
| A. INPUT TEST .....   | 45        |
| B. OUTPUT TEST .....  | 46        |
| C. DRIVE BOARD TEST.....                                    | 47        |
| D. ACTUATOR CONTROL BOARD TEST .....                        | 49        |
| E. CONTROL TOWER COMMUNICATION TEST.....                    | 54        |
| F. CALIBRATION SETTING .....                                | 55        |
| G. GAME ASSIGNMENTS .....                                   | 60        |
| H. BOOKKEEPING .....  | 64        |
| I. BACKUP DATA CLEAR.....                                   | 67        |
| <b>4 TOWER AND BILLBOARD TEST MODE.....</b>                 | <b>68</b> |
| 4-1 TOWER CONTROL BOARD.....                                | 68        |
| 4-2 TOWER AND BILLBOARD TEST MODE.....                      | 71        |
| 4-3 SETTINGS FOR WHEN 1 OR MORE UNITS HAVE BROKEN DOWN..... | 73        |
| <b>5 ERROR DISPLAY.....</b>                                 | <b>74</b> |

# INTRODUCTION

This manual presents information and explanations on how to manage settings and run software for “**OUTRUN 2 SPECIAL TOURS SDX.**”

This manual is intended for the owners, personnel and managers in charge of operation of the product. Operate the product after carefully reading and sufficiently understanding the instructions.

In the unlikely event that the product does not function correctly, **DO NOT** allow anyone other than a technician to touch the internal system. Turn off the power to the machine, making sure to unplug the electrical cord from the outlet, and contact the office listed below or the point of purchase for this product. For information on mechanical or hardware maintenance, see the owner’s manual.

Use of this product is unlikely to cause physical injuries or damage to property. However, points that require special attention are indicated by bold text, the word “**IMPORTANT**” and the symbol below.

## **IMPORTANT**

**Indicates important information that, if ignored, may result in the mishandling of the product and cause faulty operation or damage to the product.**

### **Sega Amusements U.S.A., Inc.**

800 Arthur Avenue, Elk Grove Village, IL 60007-5215, U.S.A.

TEL: 1-847-364-9787  
TOLL FREE: 1-888-877-2669  
FAX: 1-847-427-1065

### **SEGA AMUSEMENTS EUROPE, LTD.**

Suite 3a, Oaks House 12-22, West Street, Epsom, Surrey, KT18 7RG, United Kingdom

Telephone: +44 (0) 1372 731820 Facsimile: +44 (0) 1372 731849  
e-mail: [mailbox@sega.co.uk](mailto:mailbox@sega.co.uk) <http://www.sega-amusements.co.uk>

## Definition of 'Site Maintenance Personnel or Other Qualified Individuals'

### **WARNING**

**Procedures not described in this manual or marked as 'to be carried out by site maintenance personnel or other qualified professionals' should not be carried out by personnel without the necessary skill or technology. Work carried out by unqualified persons may cause serious accidents, including electrocution.**

Parts replacement, maintenance inspections and troubleshooting should be carried out by site maintenance personnel or other qualified professionals. This manual includes directions for potentially dangerous procedures which should only be carried out by professionals with the appropriate specialized knowledge.

The site maintenance personnel or other qualified professionals mentioned in this manual are defined as follows:

#### **Site maintenance personnel:**

Individuals with experience in maintaining amusement equipment, vending machines, etc., working under the supervision of the owner/operator of this product to maintain machines within amusement facilities or similar premises by carrying out everyday procedures such as assembly, maintenance inspections, and replacement of units/expendable parts.

#### **Activities to be carried out by site maintenance personnel:**

Amusement equipment/vending machine assembly, maintenance inspection and replacement of units/expendable parts.

#### **Other qualified professionals:**

Persons employed by amusement equipment manufacturers, or involved in design, production, testing or maintenance of amusement equipment. The individual should have either graduated from technical school or hold similar qualifications in electrical/electronics/mechanical engineering.

#### **Activities to be carried out by other qualified professionals:**

Amusement equipment/vending machine assembly, repair/adjustment of electrical/electronic/mechanical parts.

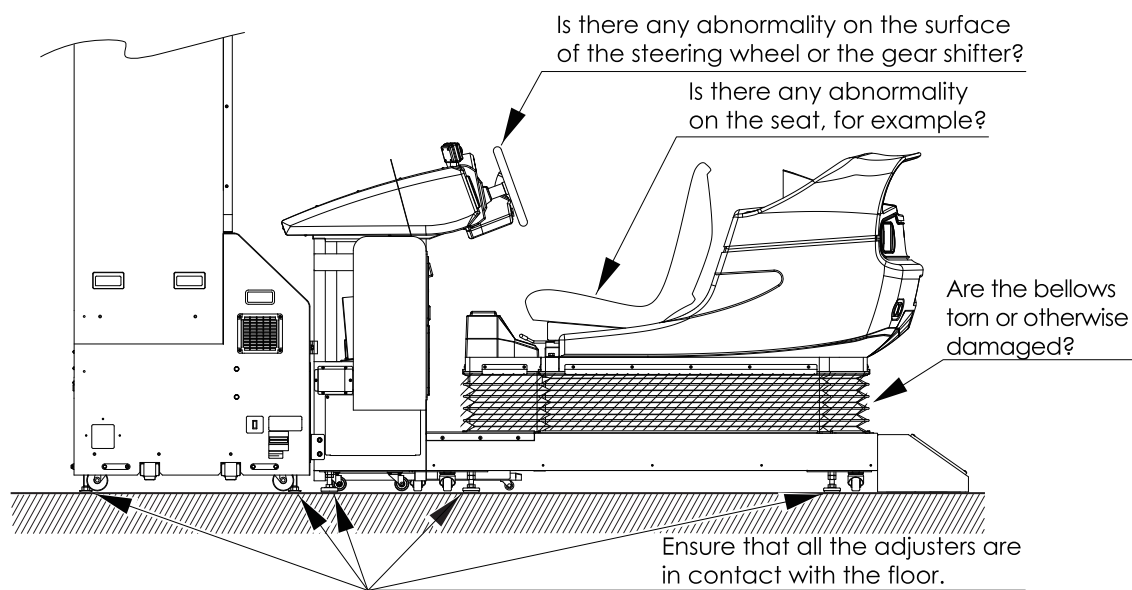
# 1 PRECAUTIONS REGARDING PRODUCT OPERATION

To avoid injury and trouble, be sure to pay attention to the behavior of visitors and players.

## 1-1 BEFORE OPERATION

### **⚠ WARNING**

- Check if all of the adjusters are in contact with the surface. If they are not, the cabinet can move and cause an accident.



- To ensure safety, carry out a trial run before starting operation, and be sure to check the safety devices. Each ride moves, so each is equipped with safety devices. Be sure to check that these safety devices function normally.
  - Can you play a game when the motion of the ride has been stopped with the motion selector switch on the control tower?
  - When ride motion has been selected, can you stop the motion of the ride with the motion selector switch on the control tower after the game has started?
  - Does the ride stop when the MOTION STOP button at the center of the control panel is pressed?
- Check each safety device and also check to see if any of the rides move abnormally. Abnormal motion may cause an accident, so do not operate the machine until the cause of the abnormality has been removed.
  - Does the ride move in the direction corresponding to the direction of operation?
  - Does the ride move smoothly?
  - Is there any undesirable looseness in the ride?
  - Is any unusual noise emitted while the ride is operating?
  - Is any unusual vibration emitted while the ride is operating?
  - Does the ride stop at an even position when the game is over?

**⚠ WARNING**

- If an abnormality occurs in the ride mechanism, immediately stop operation, turn off the power, and contact the office indicated in this manual or the point of purchase. If you continue to operate the machine while there is an abnormality in it, a serious accident such as an electric shock, short circuit, fire, or a fall may occur.
- The motion of the ride will not stop when the ride is touched by anybody other than a player. Be sure to monitor the machine during a game.
- If a part related to the actuator of the ride mechanism breaks or deforms, for example, necessitating replacement or repair of the part, request the office indicated in this manual or the point of purchase to carry out this work. Specialized knowledge, technical expertise, and tools are necessary for carrying out this work. If you attempt to carry out this work yourself, an accident may occur.
- Be sure to perform appropriate adjustment of the projector. Do not leave the machine operating with screen flickering or malfunctioning. Failure to observe this can have a bad influence upon the players' or the customers' physical condition.
- It is suggested to ensure a space for players who feel sick while playing the game to take a rest.
- Do not put any heavy items on this product. Placing heavy items on the product can cause accidents or parts damage.
- Do not climb on the product. Climbing on the product can cause accidents. To check the top portion of the product, use a stepladder.
- To avoid electric shock, check that no door & cover parts are damaged or missing.
- To avoid electric shock, short circuit and/or parts damage, do not put the following items on or in the periphery of the product.  
Flower vases, flowerpots, cups, water tanks, cosmetics, and receptacles/containers/vessels containing chemicals or water.

## CAUTION

- Inspect for the following items during a trial run. If there is any type of error, use the Test Mode, etc., to resolve the problem. If you continue use with an error, it can cause an accident or irreparable parts damage.  
Do the steering wheel and the ride move smoothly during the initialization operation? (See Chapter 7.)  
Is there any strangeness in the operability of the steering wheels or the pedals?  
Is there any abnormality in the steering wheel reaction mechanism?  
Is there any improper adjustment of the projector screen?  
Are the bellows torn or has a screw dropped out of them?
- During daily cleaning, be sure to check the surface of the steering wheel, gear shifter, and other parts that the player touches with his hands for damage, cracks, or loose screws. If a player uses the machine while it is damaged, cracked, or has a loose screw, the player may become injured.
- During daily cleaning, be sure to check the seat for any abnormality, wetness, etc. Failure to do this may result in deliberate tampering or negligence being left undetected.

## IMPORTANT

- Players directly hold the controller with their bare hands so it is recommended that wet towels (paper towels) be provided.
- Endeavor to clean the steering wheel and seat frequently.
- Provide a container or space for storing the customers' hand luggage, etc. To help prevent an accident and also protect parts, establish measures so that customers do not bring raingear, such as umbrellas, on rainy days, or juice or other beverages, into the area where the machine is installed.
- During network play, if communication is interrupted for some reason, each game will continue independently. Also, if communication is interrupted while in Customer Welcome Mode, the Test Screen will appear.
- When one cabinet connected for network play enters the Test Mode, the other cabinets will move to the Test Screen. For this reason, do not needlessly put a cabinet in the Test Mode while a customer is playing a game, even if the cabinet is not being used.
- You can make game settings and coin/credit (fee) settings individually, even for cabinets that are connected for network play. You can also change the settings of an individual cabinet to those for advanced players or beginners, for example. Normally, however, set all of the cabinets to the same settings. If you make a mistake in the fee setting, it is likely that the balance of payments and other items will be adversely affected.

## 1-2 DURING OPERATION (PAYING ATTENTION TO CUSTOMERS)

In order to prevent an accident or unnecessary trouble, the attendant or operator must endeavor to always pay attention to the behavior of the players and customer. This machine has movable rides of about the same size as an automobile. Sometimes a player or a customer may behave in an unexpected way. Be adequately aware of safety, and stop any behavior that is considered dangerous.

### WARNING

- For safety, do not allow any of the following people to play the game.
  - Those who have high blood pressure or a heart problem.
  - Those who have experienced muscle convulsion or loss of consciousness when playing video games, etc.
  - Those who have neck or spinal cord problems.
  - Those who are intoxicated or under the influence of drugs.
  - Pregnant women or those who could be pregnant.
  - Those who are not in good health.
  - Those who do not follow the attendant's instructions.
  - Those who cannot grasp the Control Unit (Gun) securely because of immobility in fingers, hands or arms.
  - Persons who disregard the product's warning displays.The game cannot be played while sitting in a wheelchair.
- For safety's sake, a person of less than 140 cm in height cannot play games on this machine. Because of the dimensions of the seat and the place where the player puts his or her feet, there is a risk that when the ride moves the player may fail to support their weight, causing the player to fall off the ride.
- Even players who have never been adversely affected by light stimulus might experience dizziness or headache depending on their physical condition when playing the game. Small children are especially likely to experience these symptoms. Caution guardians of small children to keep watch on their children during play.
- Instruct those who feel sick during play to have a medical examination.
- To avoid injury from falls and electric shocks due to spilled drinks, instruct the player not to place heavy items or drinks on the product.
- To avoid electric shocks and short circuits, do not allow customers to put hands and fingers or extraneous matter in the openings of the product or small openings in or around the doors.
- For safety's sake, warning indicators such as stickers are placed on the machine. However, a careless player will generally fail to read these warnings. The attendant must point out steps and level differences on the ride in order to prevent the occurrence of an accident.
- To avoid falls and resulting injury, immediately stop customers from leaning against or climbing on the product, etc.
- No more than 2 persons should sit on each ride of this machine. Instruct customers that 3 or more players must not sit on a ride. Failure to observe this precaution may result in players striking their bodies against each other, causing them to receive blows, fall over, or fall off the ride.
- Instruct customers not to get on or in any ride part, such as the rear of the ride or behind the back of the seat, other than the seat. Failure to observe this precaution may result in players falling over, falling off, or catching body parts in the ride.



## **WARNING**

- Entering the cabinet with a wet umbrella or wet shoes is strictly forbidden. There are electrical parts and wiring underneath the cabinet floor. If these become wet, this can cause an electric shock or short circuit. Be especially careful in managing the product on rainy days.
- Take care not to place a heavy object on a ride or seat. This may cause the object to strike the player when the ride moves.
- Instruct customers not to play a game with a child on their knees. This may cause an accident such as the child becoming caught between the control panel and the player or the child falling off the ride.
- Instruct players not to stand during a game in which the ride moves. This may result in the player falling off the ride or falling over.
- Instruct persons other than players to keep away from the machine while a game is in progress. If a person touches the moving ride, this may result in an accident such as the person falling over or getting his or her fingers caught in the bellows.
- An infant is unable to recognize danger, so instruct the guardian of the infant to be attentive and ensure that the infant does not approach the machine.

## **CAUTION**

- Immediately stop such violent acts as hitting and kicking the product. Such violent acts can cause parts damage or cause the cabinet to fall over, resulting in injury.
- Items such as large finger rings can cause injury to the fingers while playing. Instruct players to remove all accessories that could cause an accident before playing.
- Take care to ensure that two persons do not attempt to play a game by grasping a single steering wheel. Failure to heed this precaution may result in a minor or a major collision.
- Explain that the MOTION STOP Button can be pressed to stop play whenever the player feels ill.
- Explain that the attendant will stop the game if he or she judges that a situation is dangerous.
- Take care to ensure that other customers do not touch operating devices during a game. Failure to heed this precaution may result in an accident or cause trouble between customers.
- There are steps and level differences on each ride, so instruct players to be careful when getting on or off the ride.
- Do not allow players to extend their hands or feet out from the ride during play. Otherwise there could be bruises, sprains or other accidental injuries.
- Instruct the player to adjust the seat in the front-rear direction to match his or her body size. If a player plays a game in an unreasonable posture, he or she may sustain an injury or incur discomfort.

**STOP** **IMPORTANT**

- The load limit on one ride of the machine is 300 kg. If you allow a person or persons weighing more than the load limit to get on a ride and operate it, the ride may break down or wear considerably.
- If a player carries hand luggage or other items onto a ride, objects may fall off or roll over, for example, when the ride moves, resulting in injury or damage. Also, instruct players not to take breakable items, etc., onto the ride.
- After the end of a game, check to ensure that the player has not forgotten or dropped any belongings.

## 1-3 PRECAUTIONS FOR TICKET OPERATION

### WARNING

- To ensure safe operation, the attendant must pay attention to the behavior of the players and also the performance of the ride and other machine parts. The points to which the attendant must pay particular attention are as follows.
  - Ensuring that the player watches his or her step when getting on or off the ride
  - Paying attention to any belongings that the player takes onto the ride
  - Checking the number of persons
  - Explaining the precautions to be observed for preventing accidents
  - Watching the players during a game
  - Stopping the motion of the ride if an abnormality or accident occurs
  - Prohibiting access by customers other than players
  - Guiding the players off the ride at the end of the game
  - Checking for forgotten or dropped items
  - Checking the seat, steering wheel, gear shifter, etc.
  - Guiding evacuation in the event of a fire or an earthquake
- To prevent the possibility of an accident, the following persons must play without any ride motion. In order to prevent unnecessary trouble, explain this to the players before the start of the game.
  - Persons susceptible to motion sickness.
  - Those who require supporting devices, etc., to walk.
  - Those who cannot bend their knees because of illness, etc.
  - Those who have fractures or other bone abnormalities anywhere in the body.
- Before leaving the control tower, the attendant must lock the cover of the service panel. This is to prevent the possibility of a serious accident resulting from somebody tampering with the controls.

### IMPORTANT

- To operate the machine through ticket operation, unify the settings in the Test Mode of the four cabinets by entering the GAME ASSIGNMENT MENU and selecting TICKET1 (or TICKET2) for the OPERATION MODE.
- Set the main switch on the service panel of the control tower to ON. If it is not in the ON position, the control tower cannot be operated.
- For the TICKET1 or TICKET2 setting, use a ticket, token, etc. A coin cannot be used.

**[Operational Procedures Example]**

This section explains general ticket operation procedures to be conducted by the person responsible for the attraction (attendant, operator, staff member).

While using below as a reference, establish a system that is safe, suitable for the facility, and easy to operate.

Below is just one example. Since the conditions will vary depending on the environment and location in which the product is placed and its presentation, etc., bear in mind that this is only an example. Operation should not be limited to these procedures.

The various points of caution during operation are the same as found in 1-1 of this document.

**Start Standby (Reception, Guidance)**

- 1** Inform customers of the usage restrictions and confirm that they understand them. Thoroughly explain to those customers who do not meet the height requirements or physical condition requirements that they will be playing in a mode where the ride does not move.
- 2** Confirm the number of people and group them.
- 3** If running a ticket operation, collect the tickets or cards. Beginning from the F50 (red) cabinet, lead customers from cabinet 1 to 4, and have them be seated. If playing alone, have the player sit on the left side so they can more easily be recorded by the CCD camera.

**[Player Guidance Example]**

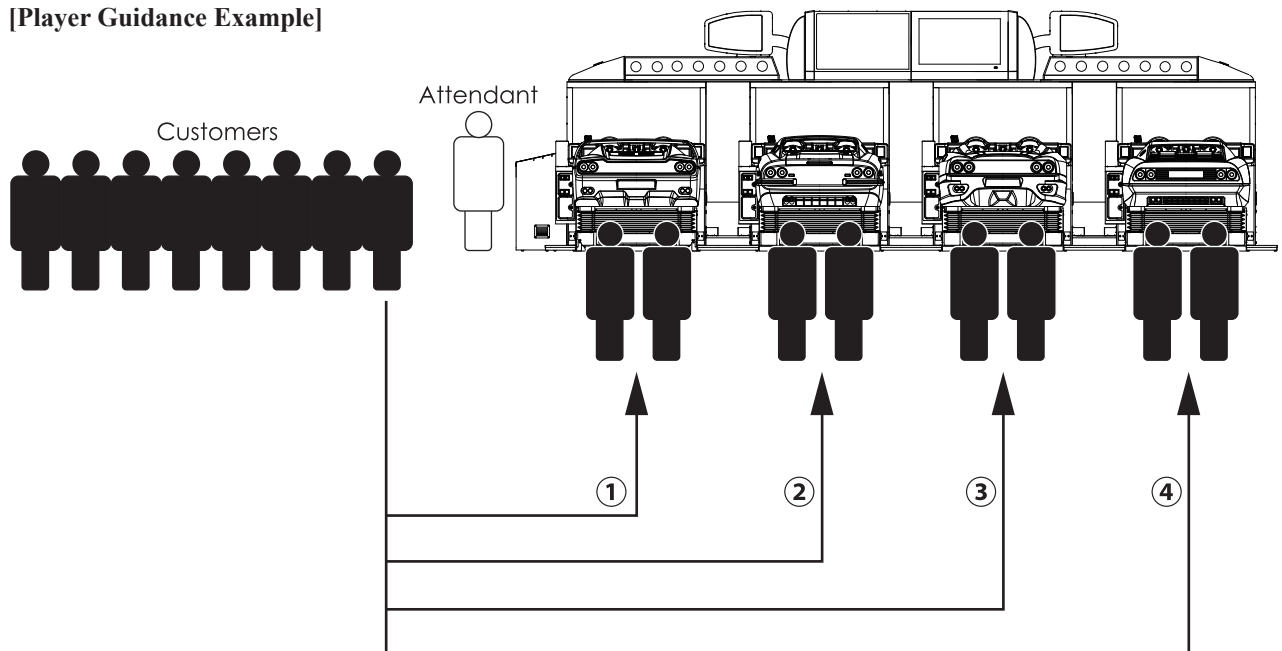


FIG. 1-2a

**Game Start Preparations**

- 1** Lead customers to each ride, and have them take a seat. There is a step between the rides. Be sure to warn customers to watch their step.
- 2** After customers take their seats, have them use the lever on the right side underneath the seat to adjust the seat position.
- 3** Explain the MOTION STOP button, game rules (driver changing), and so on.

## Game Start

- 1 Confirm that the control tower motion selector switch on the service panel is set to NORMAL (or STOP for customers that do not meet the height or physical condition requirements), and confirm that the error lamp is extinguished.
- 2 Press the respective ENTRY button one time for the rides where customers are sitting. Pressing the ENTRY button twice will cancel the entry, but pressing it again allows entry once again.
- 3 After completing the entries for rides with network play, press the START button. The customers' game screens will change to the Setup Screens.
- 4 When deciding on the number of players at the Selection of Number of Drivers Screen, the screen will pause and the attendant's input is required. If the player count is acceptable, press the ENTRY button once. If the driver count is wrong, hold down the ENTRY button for at least three seconds. Driver count selection will be cancelled, and the game will return to the Selection of Number of Drivers Screen.  
(Only in OPERATION MODE: TICKET1)

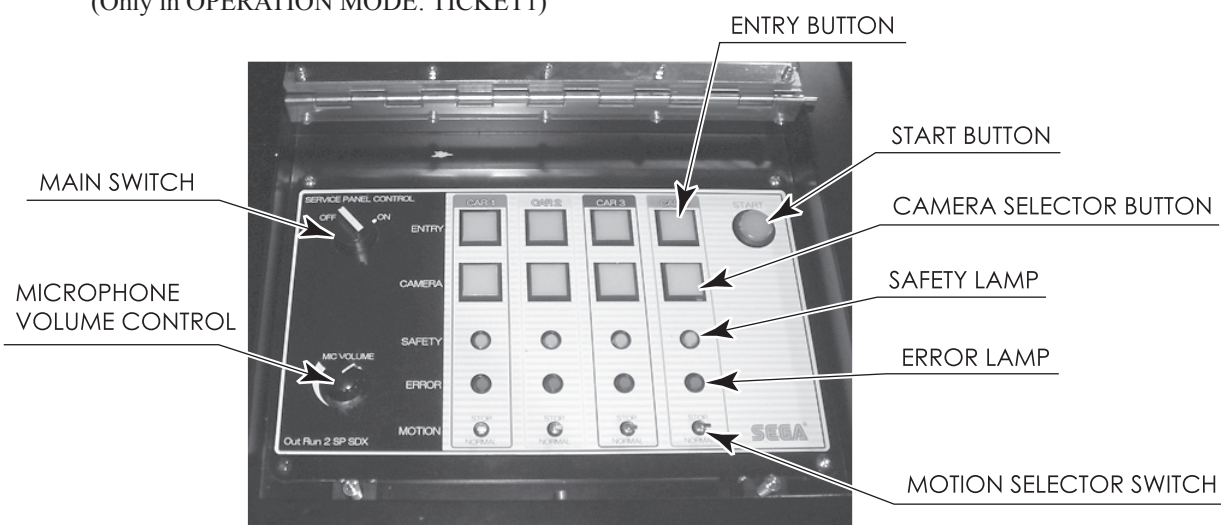


FIG. 1-2b SERVICE PANEL

### (1) Main switch

This switch allows the service panel to be operated. If it is not set to ON, the service panel cannot be used.

### (2) ENTRY button

These buttons enable any desired cabinet to be entered into a game. When the button flashes, the corresponding cabinet is in an entered status. It is possible to cancel the entered status by pressing the same button once again.

### (3) START button

This button finalizes the entries of the cabinets into the game and starts the game. During the game, the ENTRY buttons will glow until the game has completed.

#### NOTE:

When the OPERATION MODE is set to COIN, pressing the START button with one or more cabinets entered while they are at the "Waiting for entries." screen will result in the countdown being cancelled (FIG. 1-2c Waiting for entries.) and the waiting time extended. Pressing the START button once again will immediately start the game with the cabinets that have entered.



FIG. 1-2c

**(4) CAMERA selector button**

These buttons enable any desired CCD camera image to be selected. The CCD camera video from the illuminated button's corresponding seat is displayed on the billboard's LCD screen. The video of the ride whose video you want to be displayed on the LCD screen will be displayed on the LCD screen while the seat's corresponding button is pressed.

**(5) SAFETY lamp**

While this lamp is lit, the motion operation of the ride is enabled. When the lamp is out, the ride is in a stopped condition.

Lit: Motion takes place normally.

Out: The motion selector switch on the tower side is in the STOP position.

Blinking: The motion stop switch on the ride side has been pressed.

**(6) ERROR lamp**

Starts blinking when an error has occurred. The error status will be shown by the button's illumination.

Out: Communicating normally.

Blinking: There is an abnormality in the communications of the tower control board and actuator control board.

**(7) MOTION selector switch**

This switch allows changing between STOP and NORMAL for the in-game motion. However, the ride will not move until the game is over if the switch is set to STOP when the game starts.

**(8) Microphone volume control (MIC VOLUME)**

This is for adjusting the volume of the microphone used by the attendant for announcements.

**● OPERATION MODE Settings**

Attendant operation of the control tower is affected by each setting as shown below.

**TABLE 1-2**

| OPERATION MODE | Operation of control tower  | Work procedure   |  |  |
|----------------|---|--|--|--|
|                |   | Operation 1 Entry method   | Operation 2 Game start method  | Operation 3 Selection of number of drivers   |
| TICKET 1       | Yes:<br>Entry and game start operations can be performed from the control tower, and any incorrect input, which was made when deciding the number of drivers, can be canceled, and a selection made once again. | Press the ENTRY button corresponding to the cabinets that you wish to enter into a game. | Upon completion of the entry, press the START button.  | Once the players have determined the number of drivers, the screen pauses temporarily, and the machine waits for input from the attendant. Provided that there is no problem with the selection, the attendant should briefly press the ENTRY button of the desired cabinets. Then, the next selection screen appears.<br>If a mistake was made in the selection of the number of drivers, pressing the ENTRY button of the desired cabinets for an extended period (at least 3 seconds) will cause the previous screen to reappear. |
| TICKET 2       | Yes:<br>Entry and game start operations can be performed from the control tower.  | Press the ENTRY button corresponding to the cabinets that you wish to enter into a game. | Upon completion of entry, press the START button.<br><br>This completes the work of the attendant. | No   |
| COIN           | No  | No   | No   | No   |

**5** After selecting the number of drivers, players will advance through the versus stage, transmission, and BGM Selector Screens. Once all rides have completed their selections, the race will start.

**< Attendant Announcement Examples >**

Attendant: “Choose a course for this race. Please choose your preferred stage. Course selection is based on a majority rule. The course that gets the most votes will be the course for this game.”



FIG. 1-2d

Attendant: “AT (Automatic) will automatically shift speeds. In MT (Manual) you use the gear shifter in the center to change speeds. Highlight your choice with the steering wheel, and select it by stepping on the gas pedal.”

*NOTE:*  
Since the countdown is short, quickly introduce only the major points.

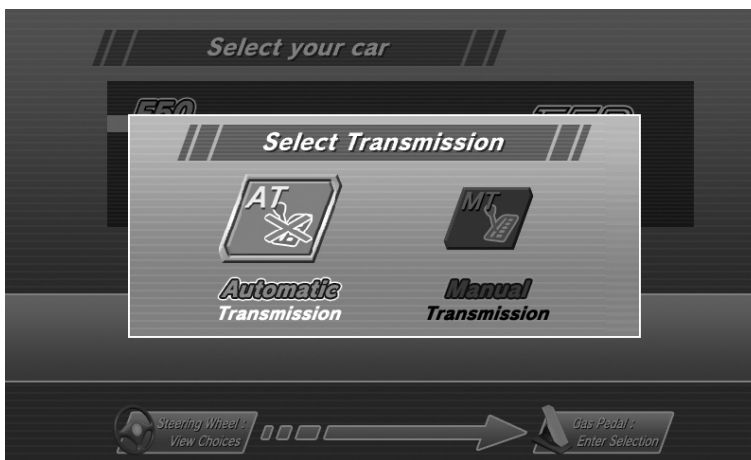


FIG. 1-2e

Attendant: “Finally, choose the music (BGM) that will play during the game. You can choose different music (BGM) by pressing the VIEW CHANGE button. Highlight your choice with the steering wheel, and select it by stepping on the gas pedal.”



FIG. 1-2f

Selection Process Completed  
 After the following screen is displayed, the race starts.



FIG. 1-2g

**During the Race**

- 1 Operate the ride while confirming that customers are safely playing the game.
- 2 Stop motion if necessary when watching over the customers.
- 3 The ride ENTRY buttons will glow during the race.
- 4 Add excitement to the race with narration via the microphone as you watch the billboard display and game screens.

< Attendant Announcement Examples >

- **Points about Drifting**  
 Attendant: "Customer in the red car, showing off awesome drifting skills on the corners!"  
  
 Attendant: "If you hit another car or a wall while you're drifting, the drivers will change... so if you're not driving right now, be ready!"



FIG. 1-2h



○ **Fork in the Road**

Attendant: “There’s a fork coming up soon! The course on the left has a lower difficulty. If you’re confident in your abilities, you can go right and try to get in the lead!”

Attendant: “There is a driver change after the fork! Get ready!”



FIG. 1-2i

○ **Crash**

Attendant: “Oooh, the red car that broke away is now flipping over!”

Attendant: “Looks like the silver car went off course while battling doggedly for second place!! They’re not out of it yet, though!”



FIG. 1-2j

○ **Finish Line**

Attendant: “Take the last corner... the finish line is close! Who’s going to reach the checkered flag first!?”

Attendant: “Finish!! The blue 360 Spider comes in 1st place! The red F50 in 2nd! And 3rd place??!!”



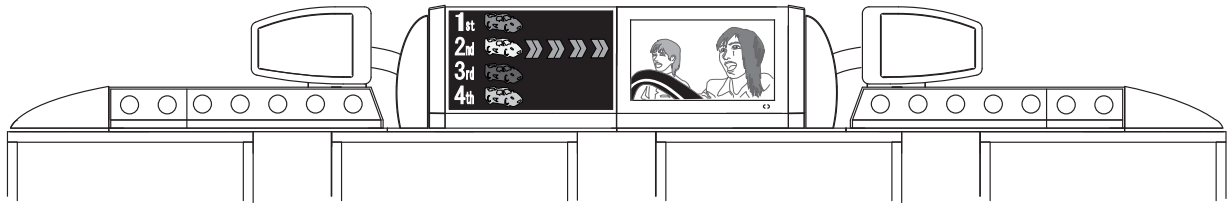
FIG. 1-2k

● **Billboard**

You can view the players' rank and faces during the game by looking at the billboard and LCD monitor. They are good tools to use when utilizing the microphone.

The colors of the cars on the rank display LED match the colors of the cabinets. Also, the car with arrows next to it represents the car whose camera video feed is currently being displayed.

In the figure below, the F50 (red) is in first place, the Dino246 (yellow) is in second place, and the same car's video feed is currently being displayed.



**FIG. 1-21 BILLBOARD**

**Game Completion**

- 1** At the end of the game, the ENTRY buttons of the rides who participated in the race will extinguish.

---

- 2** Before players get off of the rides after play is complete, explain that you will help them down from the rides and guide them away from the attraction.

---

- 3** Inform customers that the game is complete and show the route away from the attraction.

---

- 4** Have them get out of the rides.

---

- 5** Request that they remember their belongings and watch their step as they exit the attraction.

---

- 6** Lead them to the exit.

---

- 7** Prepare for welcoming the next group of customers.

## 1-4 SWITCHING OFF THE POWER

If the power is turned off when the actuator that moves the ride is in an elongated condition, noise will be emitted when the ride contracts.

Although there is no concern about wear or overloading, this occurrence is likely to cause apprehension. The following is an explanation of how to turn the power off quietly by adhering to a certain set of steps.

Note, however, that this power off procedure cannot be conducted while a game is in progress.

- 1** Turn off the main switch on the service panel of the control tower. (See Fig. 1-2b.)
- 2** When you wish to turn off the power switches of the four cabinets, press the START button on the service panel for an extended period. Press the START button continuously for at least 3 seconds until the rides start to move.
- 3** Each ride will move to its bottommost point and then stop.
- 4** Turn off the power switch on the control tower. This switch is behind the lid on the left side seen facing the control tower. (See owner's manual FIG. 4c.)

If you turn off the power without carrying out the above procedure, the ride will descend a little at a time while emitting a noise. This is the noise of the elongated actuator contracting.

Although the actuator will not wear due to this operation, you should carry out the above procedure before turning off the power.

- 5** Before carrying out maintenance on a particular cabinet and cockpit, turn off the power switch on the side of the DLP base of the target cabinet. (See owner's manual FIG. 4b.)

To turn off only the target cabinet, press the ENTRY button for the target cabinet on the service panel for an extended period.

Press the button continuously for at least 3 seconds until the ride starts to move.

Only the ride of the target cabinet will move to its bottommost point and then stop.

## 2 GAME DESCRIPTION

The following explanations apply when the product is functioning satisfactorily. Should there be any operations different from the following contents, some sort of abnormality may have occurred. Immediately look into the cause of the fault and eliminate the cause thereof to ensure satisfactory operation.

The billboard halogen lamps will constantly blink when it has power, and the rear fluorescent light will glow.

The billboard ranking board has random displays.

The billboard LCD monitor has random displays.

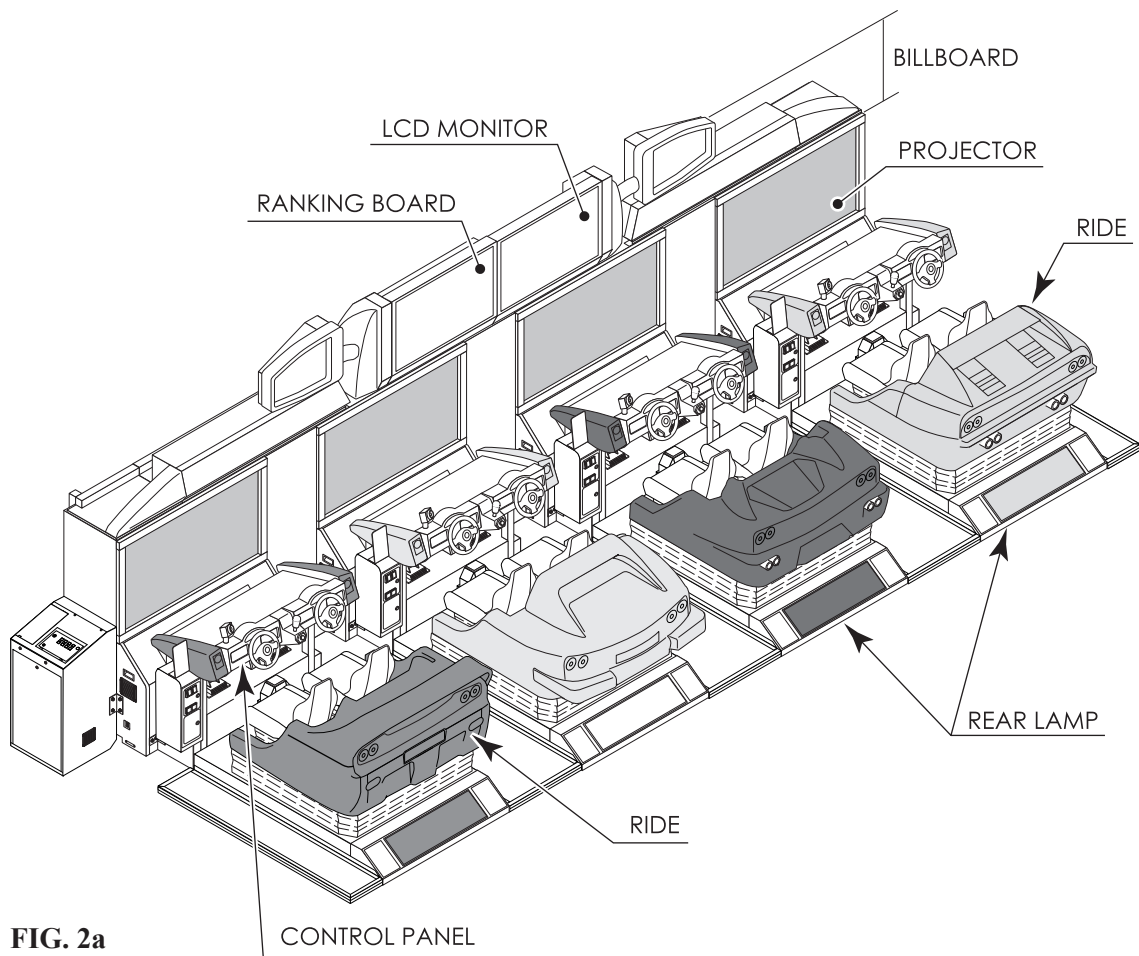
The projector screen is showing the demo video or rankings.

There is sound output from the left and right speakers of the control panel.

Also, you can choose if sound will be output during Customer Welcome Mode via the settings in Test Mode.

The START button and the VIEW CHANGE button on the control panel are integrated with a lamp.

### 2 GAME DESCRIPTION



## 2-1 BASIC CONTROLS

This product can be operated by either coins or tickets.

If using ticket operation, an attendant (operator) will continuously operate the ride.

### [Starting the Game]

- Insert a coin and press the START button. (when coin-based)
- At the Selector Screens, choose the number of drivers, cars to be used in the game, game mode, BGM, and so on. Players highlight selections with the steering wheel, and make choices with the gas pedal or START button.

### [Game Controls]

- Control the car with the steering wheel, advance the car with the gas pedal, and stop the car with the brake pedal.
- When using manual transmission, use the gear shifter to shift gears up and down.
- Switch between the three viewpoints using the VIEW CHANGE button.
- Stop the ride (car body) from moving with the MOTION STOP button. The ride will not move again for the duration of the game.

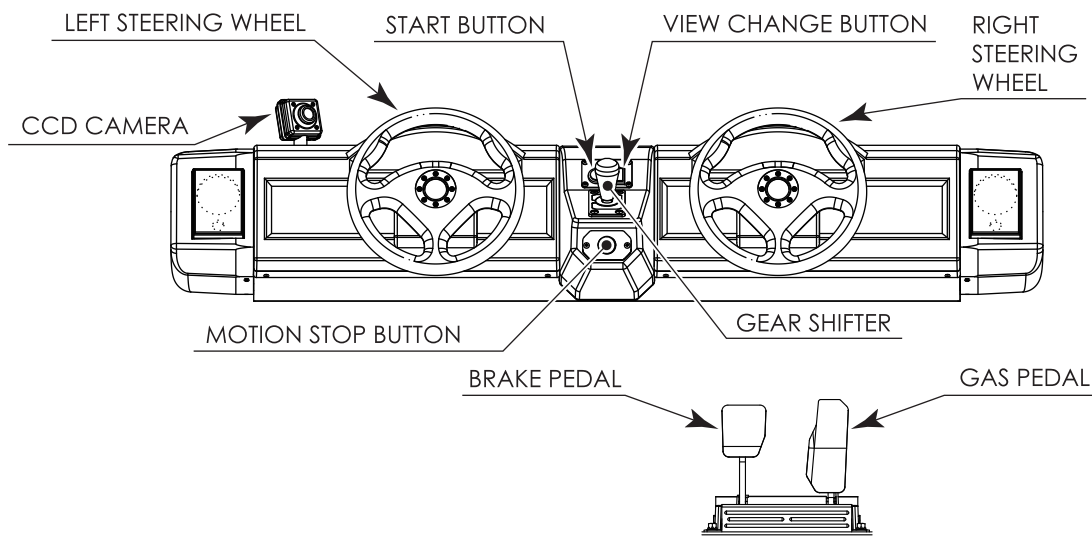


FIG. 2b

## 2-2 GAME OUTLINE

This product is a driving game with moving rides.

One or two people ride in one ride, and play the game.

When 2 people are driving, they ride in the left and right driver seats, and if their car collides with another car, hits a wall, or reaches a fork in the road, control of the car will switch to the other driver.

Players race to reach the finish line within the time limit.

The time limit is extended at each checkpoint.

The game ends when the player runs out of time or reaches the goal.

Each game stage ends with a fork in the road where the player must decide the route using the car during the race. The left-hand routes lead to less difficult stages.

A single course consists of 15 stages, with five separate goal areas. The game has two courses, the OutRun2SP course and the OutRun2 course.

The three single player game modes are OutRun Mode, Heart Attack Mode, and Time Attack Mode.

Versus Play allows up to four cabinets (8 people) to participate.

### Route Guide with stage names

#### OutRun2SP Courses

|     |             |               |             |            |             |               |                |
|-----|-------------|---------------|-------------|------------|-------------|---------------|----------------|
|     |             |               |             |            | 5A:         | Giant Statues |                |
|     |             |               |             | 4A:        | Lost City   |               |                |
|     |             | 3A:           | Water Falls |            | 5B:         | Legend        |                |
|     | 2A:         | Bay Area      |             | 4B:        | Casino Town |               |                |
| 1A: | Sunny Beach |               | 3B:         | Big Forest |             | 5C:           | Floral Village |
|     | 2B:         | National park |             | 4C:        | Ice Scape   |               |                |
|     |             | 3C:           | Canyon      |            | 5D:         | Milky Way     |                |
|     |             |               |             | 4D:        | Jungle      |               |                |
|     |             |               |             |            | 5E:         | Skyscrapers   |                |

#### OutRun2 Courses

|     |            |           |             |                   |                    |                 |               |
|-----|------------|-----------|-------------|-------------------|--------------------|-----------------|---------------|
|     |            |           |             |                   | 5A:                | Tulip Garden    |               |
|     |            |           |             | 4A:               | Cloudy Highland    |                 |               |
|     |            | 3A:       | Castle Wall |                   | 5B:                | Metropolis      |               |
|     | 2A:        | Deep Lake |             | 4B:               | Industrial Complex |                 |               |
| 1A: | Palm Beach |           | 3B:         | Coniferous Forest |                    | 5C:             | Ancient Ruins |
|     | 2B:        | Alpine    |             | 4C:               | Snow Mountain      |                 |               |
|     |            | 3C:       | Desert      |                   | 5D:                | Imperial Avenue |               |
|     |            |           |             | 4D:               | Ghost Forest       |                 |               |
|     |            |           |             |                   | 5E:                | Cape Way        |               |

## 2-3 SETUP SCREEN ORDER AND CONTENTS

This section explains the available options and controls for the setup screens.

### 1. Versus Mode Entry

If several machines are linked together (when the ride is coin-based), inserting a coin and pressing the START button on one machine will result in the message “Entry has been closed. Please stand by.” to be displayed on the screen, following which opposing players have the chance to enter the race on other machines.



Selector Screen 01

Any linked machines that players can race on display the message, “Waiting for entries.” Other players can join the race by inserting a coin and pressing the START button.

*NOTE: See the later section “ 3. Versus Play Setup” for details of game flow after all players have joined the race.*



Selector Screen 02

### Closing Versus Mode Entry

To close Versus Mode entry, press the VIEW CHANGE button and the brake pedal at the same time before other players join. (Press the brake pedal while holding down the VIEW CHANGE button.)

Versus Mode entry time can also be run down to “0” by holding the START button, thus closing Versus Mode entry.

By closing Versus Mode entry in either of the above ways, the Single Player Mode will commence, provided no players have already joined.

*NOTE: See the later section “ 2. Single Player Setup” for details of game flow after a single player race has been selected.*

## 2. Single Player Setup

### (1) Choose Main Driver

#### Controls:

In the left or right seat, press the gas pedal to choose that side as the Main Driver (the person who will play first).

After the Main Driver has been decided, the control panel on the Main Driver's side will light up green. After Main Driver selection, the Selector Screens can only be operated with the steering wheel and pedals on the Main Driver side.



Selector Screen 03

### (2) Selection of Number of Drivers

#### Controls:

From the Main Driver side, highlight the desired player count – “1 Driver” or “2 Drivers” – with the steering wheel, and confirm the choice with the gas pedal.

When playing in “1 Driver,” “OutRun Mode,” “Heart Attack Mode,” and “Time Attack Mode” can be chosen, but only “OutRun Mode” can be chosen when using “2 Drivers.”

Under coin operation, a message telling players to add credits will be displayed on top of the 2 Drivers icon. Inserting the designated amount of credits (coins) will allow the 2 Drivers icon to be selected.



Selector Screen 04



### (3) Player's Car Selection

#### Controls (Main Driver Side):

[Steering Wheel: View Choices],  
 [Gas Pedal: Enter Selection],  
 ["Brake Pedal" + "Shift": Color Change]

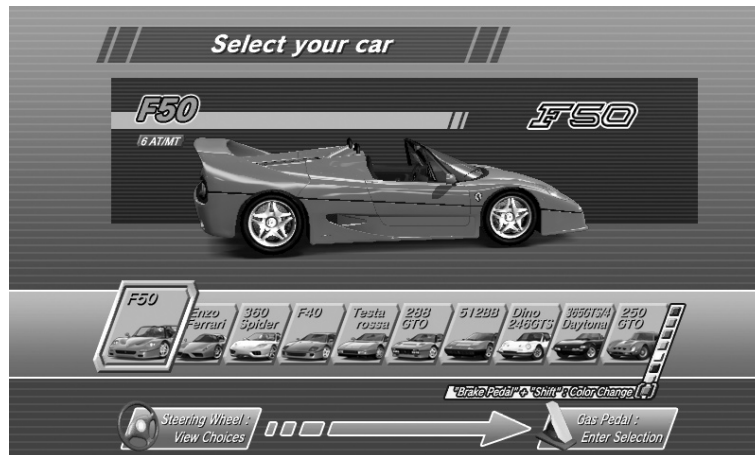
The player can select one of the following 10 cars:  
 "F50", "Enzo Ferrari", "360 Spider", "F40",  
 "Testarossa", "288 GTO", "512 BB", "Dino  
 246 GTS", "365 GTS/4, Daytona", "250  
 GTO"



Selector Screen 05

#### Changing the Car Color

Pressing the brake pedal on the Main Driver side displays the available colors for the player's car at the bottom-right of the screen. A color can be selected by moving the gear shifter up or down. In accordance with the selected color, the color of the car displayed on the screen also changes.



Selector Screen 06

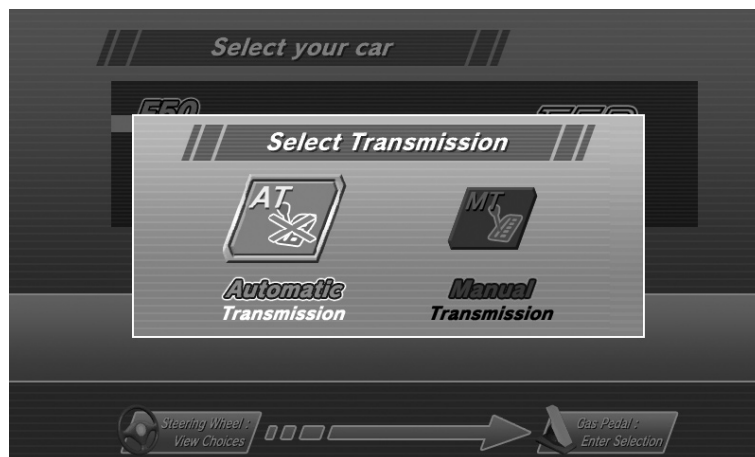
### (4) Transmission Selection

#### Controls (Main Driver Side):

[Steering Wheel: View Choices],  
 [Gas Pedal: Enter Selection]

After the player has selected a car, they can then choose the type of transmission.

- Automatic Transmission:  
 Shifting gears up and down is performed automatically (the player does not use the gear shifter).
- Manual Transmission:  
 The player shifts gears up and down using the gear shifter.



Selector Screen 07

For Manual Transmission, the number of gears depends on the model of the car.

6-Speed : F50, Enzo Ferrari, 360 Spider

5-Speed : F40, Testarossa, 288 GTO, 512 BB, Dino 246 GTS, 365 GTS/4 Daytona, 250 GTO

## (5) Game Mode Selection



Selector Screen 08

**Controls (Main Driver Side):**

[Steering Wheel: View Choices], [Gas Pedal: Enter Selection], [View Change Button: OutRun2/OutRun2SP]  
The player selects which game mode they will play.

- **OutRun Mode:**  
<Try to reach the goal with your girlfriend.>  
Earn points by overtaking enemy or rival cars on your way to the finish line.
- **Heart Attack Mode:**  
<Try to get as many “HEARTS” as possible by meeting your girlfriend’s demands.>  
Carry out the various requests your girlfriend makes and try to accumulate hearts.
- **Time Attack Mode:**  
<Drive against the Ghost Car and challenge for the course record!!>  
Compete against the fastest time achieved by another player on the machine (the ghost car) to set a new record.

*NOTE: See the section “ 2-4 Game Instructions ” for further details of each mode.*

Pressing the VIEW CHANGE button allows the player to select the course OutRun2.  
Pressing the VIEW CHANGE button again allows the player to select the OutRun2SP course.



Selector Screen 09

## (6) Game Mode Selection (15-Continuous Course Mode)

When the 15-Continuous Course Mode is available, two icons for that mode are added to the Game Mode Selection Screen.

*NOTE: See the section "Test Mode" for information on how to setup 15-Continuous Course Mode.*



Selector Screen 10

Points about the additional 15-Continuous Course Mode:

- **OutRun 15-Continuous Course Mode:**  
This allows the player to race 15 consecutive stages in OutRun Mode.
- **Time Attack 15-Continuous Course Mode:**  
This allows the player to race 15 consecutive stages in Time Attack Mode.

If the player has insufficient credits to play the 15-Continuous Course Mode, the outstanding required credits are displayed above the course icons. In this state, it is not possible to select that mode.



Selector Screen 11

Pressing the VIEW CHANGE button enables the selection of courses OutRun2. It is possible to select a 15-Continuous Course from OutRun2.



Selector Screen 12

**(7) Settings Selection (Time Attack Mode only)**

In Time Attack Mode, the player proceeds to the Car Settings Screen after selecting the game mode.



Selector Screen 13

**Controls (Main Driver Side):**

[Steering Wheel: View Choices], [Gas Pedal: Enter Selection]

The following settings are available:

- Normal: Emphasis on handling, with a top speed of 293 km/h.
- Tuned: Emphasis on speed, reaching 300 km/h maximum.

*NOTE: The Tuned setting is aimed at experienced players as handling is made more difficult.*

**(8) BGM Selection**



**Selector Screen 14**

**Controls (Main Driver Side):**

[Steering Wheel: View Choices], [Gas Pedal: Enter Selection], [View Change Button: Music Change], [Brake Pedal + Shift: Sound Balance Change]

The in-game background music can be chosen from a total of 14 different tunes. By selecting the RANDOM icon on the far right, the music will be selected at random.

The list of selectable music can be changed by pressing the VIEW CHANGE button.

**BGM List: First Screen**

- SPLASH WAVE
- MAGICAL SOUND SHOWER
- PASSING BREEZE
- Risky Ride
- Shiny World
- Night Flight (Includes lyrics)
- Life was a bore (Includes lyrics)

**BGM List: Second Screen**

- SPLASH WAVE -1986-
- MAGICAL SOUND SHOWER -1986-
- PASSING BREEZE -1986-
- Shake the Street -1989
- Rush a Difficulty -1989-
- Who are you -1989-
- Keep Your Heart -1989-



**Selector Screen 15**

### Sound Balance Adjustment

Pressing the brake pedal brings up the sound balance window at the bottom right of the screen. The sound balance can be adjusted by moving the gear shifter up or down.

Depending on the chosen sound balance, the relative volume of the BGM and engine noise varies.



Selector Screen 16

### 3. Versus Play Setup

#### (1) Versus Stage Selection



Selector Screen 17

#### Controls (Main Driver Side):

[Steering Wheel: View Choices], [Gas Pedal: Enter Selection]

The player selects which stages the race will contain.

- Special: A course specially designed for versus races.  
This course combines stages from both OutRun2SP and OutRun2.
- OutRun2SP: The OutRun2SP course.
- OutRun2: The OutRun2 course.

## (2) Versus Stage Selection (15-Continuous Course Mode)

When the 15-Continuous Course Mode is available, two icons for that mode are added to the Versus Stage Selection Screen.

*NOTE: See the section "Test Mode" for information on how to setup 15-Continuous Course Mode.*



Selector Screen 18

Points about the additional 15-Continuous Course Mode:

- **OutRun2SP 15-Continuous Course Mode:**  
This allows the player to race 15 consecutive stages in OutRun2SP Mode.
- **OutRun2 15-Continuous Course Mode:**  
This allows the player to race 15 consecutive stages in OutRun2 Mode.

*NOTE: See the "2-4 Game Instructions" section for details of the 15-Continuous Course Mode.*

If the player has insufficient credits to play the 15-Continuous Course Mode, the outstanding required credits are displayed above the course icons. In this state, it is not possible to select that mode.



Selector Screen 19

*NOTE: It is only possible to play the 15-Continuous Course Mode if all drivers participating in the race select it.*

**(3) Player's Car Selection**

This is only possible when VS CAR SELECT is set to SELECTABLE. (See 3-3G.)



**Selector Screen 20**

**Controls (Main Driver Side):**

[Steering Wheel: View Choices], [Gas Pedal: Enter Selection], [Brake Pedal + Shift: Player Only Mode "PO" Entry], ([View Change + Shift: No Handicap "NH" Entry])

As with Single Player Mode, there are 10 cars to choose from.

In Versus Play, car colors are fixed - Player 1: Red, Player 2: Yellow, Player 3: White or Silver (depending on the car model), Player 4: Black.

**No Handicap Setup**

When a player is in 2nd position or below during Versus Play, they are compensated to help them catch the lead driver more easily.

No Handicap is a mode without this compensation.

Pressing [View Change + Shift] (moving the gear shifter while pressing the VIEW CHANGE button) displays the "NH" icon on the left edge of the screen.

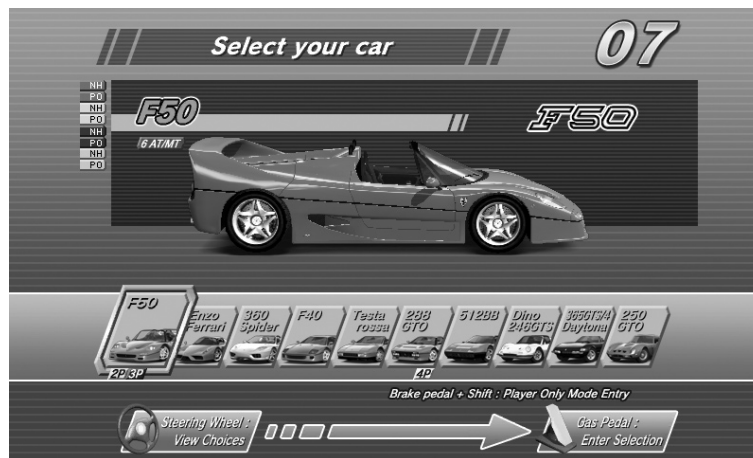
If all players participating in the race perform this operation, the race will take place in No Handicap Mode.

**Player Only Setup**

In Player Only Mode, no cars appear during the race other than the player's own car.

Pressing [Brake Pedal + Shift] (moving the gear shifter while pressing the brake pedal) displays the "PO" icon on the left edge of the screen.

If all players participating in the race perform this operation, the race will take place in Player Only Mode.



**Selector Screen 21**



#### (4) Transmission Selection

This operation is carried out in the same way as described in the section “2. Single Player Setup”.

#### (5) BGM Selection

This operation is carried out in the same way as described in the section “2. Single Player Setup”.

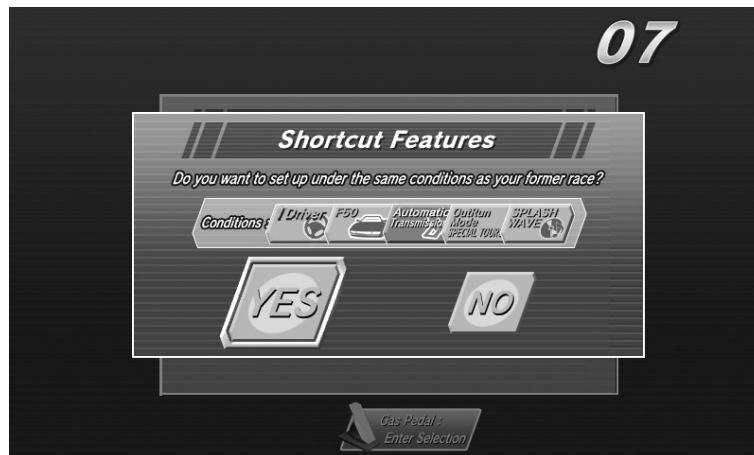
### 4. Special Controls

#### Shortcut

During setup, the player can choose to start with the same settings as the previous game by performing the following operation:

[Brake Pedal + View Change + Shift Up (putting the gear shifter in the down position while pressing the brake pedal and the VIEW CHANGE button)].

This combination of controls opens the shortcut window on the screen.



**Selector Screen 22**

By turning the steering wheel to highlight “YES” and selecting it with the gas pedal, play starts with the same settings as the previous game.

If “NO” is selected, the window closes and the player is returned to the setup screen.

*NOTE: If the previous game was in 2 Player Mode, Versus Play Mode, or 15-Continuous Course Mode, this shortcut cannot be chosen.*

## 2-4 GAME INSTRUCTIONS

### 1. Common Features in All Modes

#### Display Breakdown (All Modes)



Game Screen 01

The time counter is displayed at the top-center of the screen.

- If the time counter reaches zero, the game is over.
- Extra time is added when a checkpoint is passed.
- When playing in 2 Player Mode, the “Driver Symbol” will display on the side of the driver’s seat which can control the vehicle.
- When slipstreaming, “Slipstream” is displayed underneath the time counter.

At the top-left of the screen the total time (in Single Player Mode), position (in Versus Play Mode) and route map are displayed.

- The total time shows how much time has passed since the start of the game (in Single Player Mode).
- The position display shows the position the player is currently in, between the start and the finish line (in Versus Play Mode).
- The route map shows the route the player has taken up to this point.  
(An icon is displayed to the side of this at forks indicating the next stage.)

At the bottom-left of the screen the speed meter and tacho meter are displayed, as well as the shift and shift-up indicators.

- The speed meter shows the player’s current speed.  
(When slipstreaming, the color of the number changes to blue.)
- The tacho meter shows the speed the engine is currently revving at.
- The shift indicator shows the currently engaged gear.
- The shift-up indicator lets the player know the correct time to move up a gear.  
(It flashes red when it is time to shift up a gear.)

*NOTE: The shift-up indicator is not displayed if the player has selected Automatic Transmission.*

## Game Controls (All Modes)

### How to Drift



Game Screen 02

**1** After letting go off the gas pedal, immediately press the brake pedal.

**2** Turn the steering wheel hard and fast in the direction of a corner and press the gas pedal.

OR

When using Manual Transmission, drop down a gear shifter just before a corner and turn the steering wheel hard in the direction of the corner.

### Slipstreaming



Game Screen 03

By driving behind an enemy car or the car of another player, it is possible to pick up a slipstream. When slipstreaming, the player experiences enhanced acceleration and can drive faster than the car's specified top speed.

The following changes are seen when slipstreaming:

- "Slipstream" appears below the time counter.
- The color of the speed meter display turns blue.
- The engine noise becomes slightly louder.

## 2. Single Player: OutRun Mode

### Display Breakdown



Game Screen 04

The score is displayed at the top-right of the screen, underneath this is an animated display of any points received for passing enemy cars.

### Game Instructions

Put simply, this is a mode where you enjoy taking a drive with a girl. Choose either the left or right road when you come to a fork and aim to reach the finish line within the time limit. There are different endings depending on which finish line you cross.

Your score goes up each time you overtake a faster enemy car.

### Hints for attaining a high score

Among the enemy cars there is a rival car which is marked with the word “RIVAL” above it. The rival car is fast and difficult to pass, but there is a large point bonus if you do manage to.

The score you get for passing enemy cars varies depending on how you take them. Try to find the highest scoring method for overtaking.

### 3. Single Player: Heart Attack Mode

#### Display Breakdown



Game Screen 05

The number of hearts collected is displayed at the top-right of the screen.

At the bottom-right of the screen, the total number of hearts collected and a girl's silhouette is displayed. As the total number of hearts collected increases, the girl's silhouette is filled out with color.

#### Game Instructions

In this mode, you impress a beautiful girl by doing everything she asks.

You must collect hearts which give an indication of how impressed the girl is with you.

You have to carry out the girl's requests in the interval between "START" and "END" being displayed.

You collect hearts in accordance with how well you carry out the various requests your girl asks of you.

The girl rates your performance in the following levels:

[AAA, AA, A, B, C, D, E]

#### Hints for picking up a lot of hearts

Crashing or bumping into enemy cars reduces the number of hearts you can get, so drive carefully.

If you continually achieve good ratings you may be given a "Special Request". That's your chance to really impress her and get a triple-A score!

#### 4. Single Player: Time Attack Mode

##### Display Breakdown



Game Screen 06

At the top-right of the screen, the lap time for each stage is displayed.  
(If the time is faster than the ghost car, it is displayed in green.)

At the bottom-right of the screen, the time for each sector of the stage is displayed.

When each sector is completed, ghost car information is displayed on the center left and right of the screen.  
[On the left is data for the ghost car that took the left-hand road at the fork.]  
[On the right is data for the ghost car that took the right-hand road at the fork.]

The data is displayed in the following order:

- The ghost car icon (model and color), and the ghost car driver's name.
- Ghost: The ghost car's sector completion time.
- Player: The player's sector completion time.
- Diff: The time difference between the ghost car and player's completion times.  
(In green if the player is faster than the ghost car or red if the player is slower.)

The car's setup and transmission are shown at the bottom-left of the screen.

##### Game Instructions

In this mode you compete against the ghost car's time.

You aim to overtake the ghost car on each course and record your own fastest time to become the ghost car.

The ghost car represents the fastest recorded time on each stage.

If you drive faster than the ghost car, your player data will be recorded as the ghost car data, and any subsequent plays of the same stage will operate with your car as the ghost car.

If you enter your name on the name entry screen you can also add that to the ghost car data.

Even if you quit the game part way through, if you have recorded a faster time than the ghost car, you will have the opportunity to enter your name.

Each stage has data for two ghost cars; one which took the left-hand road at the fork and one which took the right-hand road.

The fifth stage has no fork so there is only data for one ghost car.

The fastest player on each course is saved separately as the top ghost car.

If you enter the fifth stage within 1 second of the fastest player, the top ghost car appears in addition to the normal ghost car. ("TOP" is shown above the car.)

If you beat the top ghost car, you become the fastest player for that course.

Pressing the START button toggles the display of the ghost car on and off.

## 5. Versus Play

### Display Breakdown



Game Screen 07

Opponent data is displayed at the top-right of the screen.

Each player's information is indicated with a face icon, and their current status is shown by the expressions on the faces and with speech.

The order of the faces changes to reflect the race order.

### Game Instructions

The starting grid order is determined by the order of entry into the game.

The first player to reach a fork can decide whether the race will continue down the left-hand or right-hand road.

It is possible to set No Handicap Mode, which eliminates compensation for trailing drivers, or Player Only Mode, where enemy cars are not displayed.

*NOTE: See the previous section "3. Versus Play Setup" for details.*

As soon as one of the competing players passes the finish line, the time counter display shows "Extra Time".

The game is over for players who do not manage to finish within the "Extra Time" period.



Game Screen 08

## 6. 15-Continuous Course Mode

When 15-Continuous Course Mode is enabled, the following game modes are available:

- “OutRun 15-Continuous Course Mode” (Single Player)
- “Time Attack 15-Continuous Course Mode” (Single Player)
- “OutRun2SP 15-Continue Course Mode” (Versus Play)
- “OutRun2 15-Continuous Course Mode” (Versus Play)

### Display Breakdown



Game Screen 09

The 15-Continuous Course Mode differs from the normal game in the following ways:

- The route map changes to the 15-Continuous Course map.
- In Versus Play, the position display is modified.

### Game Instructions

The 15-Continuous Course is a course combining all 15 stages.

The stages are interconnected in the following order:

[1A→2A→2B→3A→3B→3C→4A→4B→4C→4D→5A→5B→5C→5D→5E]

At the end of each stage, both branches of the left-right fork lead to the same stage that follows.



## 7. Game Pause

The game can be paused with the following combination of controls (in Single Player Mode only):

With the car stopped, press [Brake Pedal + View Change + Shift Up (Put the gear shifter in the down position while pressing the brake pedal and VIEW CHANGE button down)]

This combination of controls opens the pause window on the screen.



**Game Pause Screen**

By turning the steering wheel to highlight “YES” and selecting it with the gas pedal, the game comes to an end.

If “NO” is selected game play resumes.

(After “NO” has been selected once, it is no longer possible to use the game pause command again.)

The game pause command will not work in the following circumstances:

- When the player is in the vicinity of the start area.
- When the remaining time is 8 seconds or less.
- When the game has already been paused once before, and “NO” was selected.

## 2-5 NAME ENTRY AND INTERNET RANKING

### 1. Name Entry



Name Entry Screen

#### Controls:

[Steering Wheel: View Choices], [Gas Pedal: Enter Selection], [Brake Pedal: Delete], [Start Button: END] (Moving the gear shifter up and down selects letters.)

This game has a function that can register all Single Player results with an Internet ranking system. After finishing a game in Single Player Mode, the player enters their name for Internet ranking purposes, even if they have not achieved a rank on the actual machines they are playing on.

If the player gets into the ranking on the machine they are using, the name they enter will be used in that machine's advertising demo display.

If the player makes a new ghost car record, their name is displayed with the new ghost car data.

## 2. Internet Ranking



Internet Ranking Screen

After the player has entered their name, an Internet ranking password is displayed.

Pressing the VIEW CHANGE button switches to the game's in-depth data display.

Visit the following URL for Internet ranking registration and listings:

<http://outrun.jp/>

The Internet ranking is calculated separately for the following game modes and courses:

### OutRun2SP Courses

- OutRun Mode: Each course (A – E) + the 15-Continuous Course
- Heart Attack Mode: Each course (A – E)
- Time Attack Mode [Normal, AT]: Each course (A – E) + the 15-Continuous Course
- Time Attack Mode [Normal, MT]: Each course (A – E) + the 15-Continuous Course
- Time Attack Mode [Tuned, AT]: Each course (A – E) + the 15-Continuous Course
- Time Attack Mode [Tuned, MT]: Each course (A – E) + the 15-Continuous Course

### OutRun2 Courses

- OutRun Mode: Each course (A – E) + the 15-Continuous Course
- Heart Attack Mode: Each course (A – E)
- Time Attack Mode [Normal, AT]: Each course (A – E) + the 15-Continuous Course
- Time Attack Mode [Normal, MT]: Each course (A – E) + the 15-Continuous Course
- Time Attack Mode [Tuned, AT]: Each course (A – E) + the 15-Continuous Course
- Time Attack Mode [Tuned, MT]: Each course (A – E) + the 15-Continuous Course

### 3 EXPLANATION OF TEST AND DATA DISPLAY

#### WARNING

- Do not touch any parts that are not specified in these directions. Touching unspecified locations may lead to electric shock or cause short circuits.
- In Test Mode, the ride (car body) will move in accordance with the controls. Be sure that persons other than the conductor of the test are not near the product while the Test Mode procedures are in progress. Failing to follow this precaution could result in major or minor collisions or falls.
- Be careful when riding on the ride while operating Game Test Mode. Improper operation can result in falling. To ensure safety, stand at the bottom of the base while conducting the ride movement tests.
- Upon exiting Test Mode, the ride will go through the same initialization operation as when power is turned on. Be careful because the ride will move. There is a risk of collisions, falls, and fingers being caught.

#### CAUTION

- Because of the position of the switch unit, you must assume an unnatural posture to operate Test Mode. This can cause pain in the shoulder, waist, etc. You could also get caught by parts in the coin chute door, for instance, and suffer abrasions. Have a flashlight on hand and operate Test Mode very carefully. The door interior is dark and narrow and you could easily make mistakes in operation.
- Be careful that a finger or hand does not get caught when opening/closing the coin chute door.

#### IMPORTANT

- When you enter the Test Mode, fractional coin and bonus adder data is erased.
- Adjust the sound to the optimum volume, taking into consideration the environmental requirements of the installation location.
- Removing the coin meter circuitry renders the game inoperable.

Perform tests and data checks periodically by manipulating the TEST Button and SERVICE Button in the cabinet. Follow the instructions in this chapter to conduct checks when the game machine is first installed, when money is being collected, or when the game machine does not operate properly.

Shown below are the tests and screens to be used for different problems.

This product uses a LINDBERGH game board and a DVD DRIVE. In the system, a different game can be played by putting a different DVD ROM in the DVD DRIVE.

For this reason, the product's Test Mode consists of two modes: a System Test Mode for systems in which coin settings, for instance, are made for products that use the same system, and a Game Test Mode for setting of difficulty level, etc., and for input/output test of operational units used exclusively with this product.

*NOTE : "S/M" in the table denotes LINDBERGH service manual, which is provided separately.*

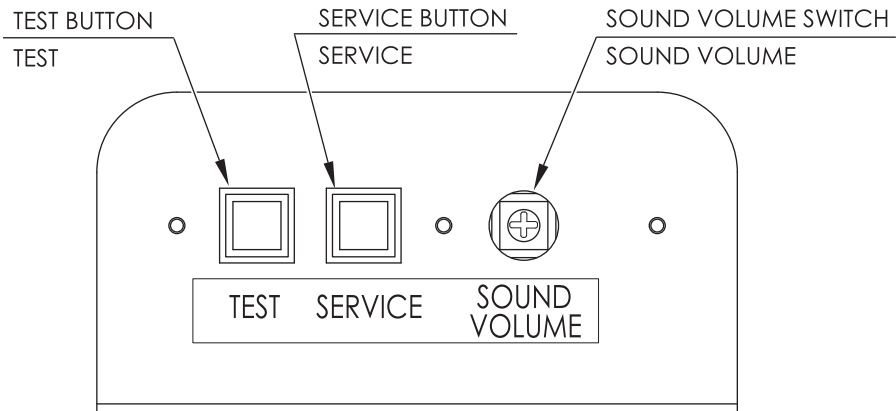
**TABLE 9**

| ITEMS                     | DESCRIPTION  | REFERENCE SECTIONS                            |
|---------------------------|--|---|
| Game machine installation | 1. Confirm that the information display screen appears in normal fashion.                        | "S/M" Chapter 4                               |
|                           | 2. Investigate each input device on the Input Test Screen.                                       | "S/M" Chapter 4, 3-3 A, F                     |
|                           | 3. Investigate each output device on the Output Test Screen.                                     | "S/M" Chapter 4, 3-3 B, C, D, E               |
| Periodic maintenance      | 1. Check settings.   | "S/M" Chapter 4, 3-3 E, G                     |
|                           | 2. Test each input device on the Input Test Screen.  | "S/M" Chapter 4, 3-3 A, F                     |
|                           | 3. Test each output device on the Output Test Screen.  | "S/M" Chapter 4, 3-3 B, C, D, E               |
| Control problem           | 1. Investigate each input device on the Input Test Screen.                                       | "S/M" Chapter 4, 3-3 A, F                     |
|                           | 2. Adjust or replace each input device.  | Owner's Manual Chapters 11, 12, 13            |
|                           | 3. If the problem persists, examine the mechanical components of each input device.              | Owner's Manual Chapters 10, 11, 12            |
| Monitor problem           | On the monitor adjustment check screen, check to be sure the monitor has been adjusted properly. | "S/M" Chapter 4, Owner's Manual Chapters 8, 9 |
| IC board problem          | 1. Information Display Screen  | "S/M" Chapter 4                               |
|                           | 2. Speaker Test  | "S/M" Chapter 4                               |
| Date Check                | Check data on game play times, histograms, etc., and adjust the level of difficulty.             | 3-3H  |

## 3-1 SWITCH UNIT AND COIN METER

### Switch Unit

In Test Mode, the switch unit in the coin chute door is operated. Unlock and open the coin chute door. Inside is a switch unit.



**FIG. 3-1a Switch Unit**

#### TEST Button (TEST):

Establishes Test Mode. Becomes the button to confirm selections in Test Mode.

#### SERVICE Button (SERVICE):

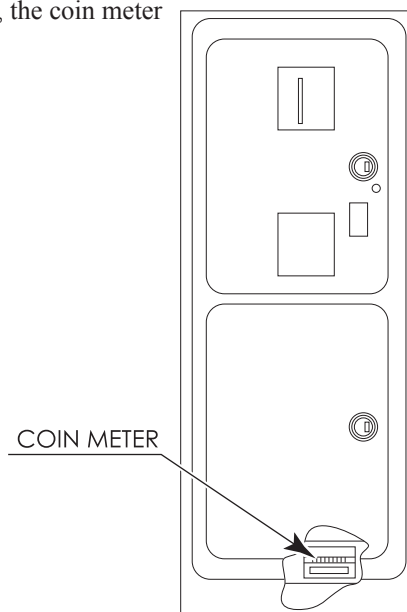
Makes it possible to enter credits for service without increasing the coin meter. Becomes the button to select items in Test Mode.

#### Sound Volume (SOUND VOLUME):

This is the volume knob for speakers at the left and right of the control panel. Turn the knob to the right to increase speaker volume.

### Coin Meter

After using a special-purpose key to unlock the cashbox door, the coin meter can be found at the bottom of the cashbox.



**FIG. 3-1b Coin Meter**

## 3-2 SYSTEM TEST MODE

### STOP IMPORTANT

- The details of changes to Test Mode settings are saved when you exit from Test Mode by selecting EXIT from the system Test Mode menu. Be careful because if the power is turned off before that point, changes to the settings will be lost.
- Use with the specified settings. If settings other than those specified are used, inappropriate operations or malfunction may occur.

In the System Test Mode, the main activities include checking LINDBERGH information and actions and the setting of coin/credit. Also, a screen appears for checking screen adjustments. For details, see the LINDBERGH service manual, which is provided separately.

Use the following settings with this product. If the settings are not as specified, error messages might appear and operations might not be normal.

- COIN ASSIGNMENTS  
COIN CHUTE TYPE: COMMON  
SERVICE TYPE: COMMON
- NETWORK SETTING  
NETWORK TYPE: MAIN  
MAIN NETWORK: SETTING NOT REQUIRED

- 1 When the TEST Button is pressed, the System Test Menu Screen (SYSTEM TEST MENU) appears.
- 2 Use the SERVICE Button to move the cursor to the desired test item.
- 3 Press the TEST Button to confirm selection of the item.
- 4 When testing and checking are completed, select EXIT and press the TEST Button. The System Test Menu Screen reappears.
- 5 When all tests are completed, select EXIT and press the TEST Button. The game screen reappears.

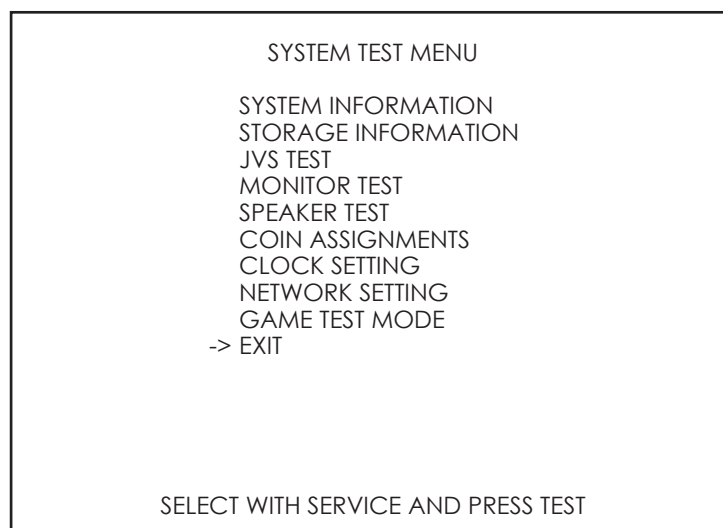


FIG. 3-2 System Test Menu Screen

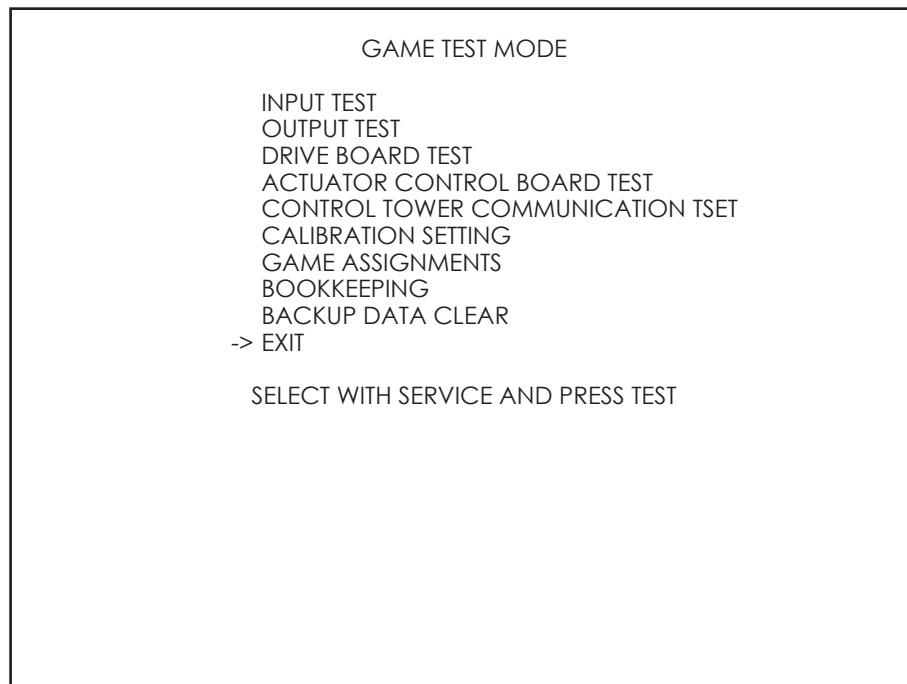
### 3-3 GAME TEST MODE

#### **STOP** IMPORTANT

To change settings in the Game Test Mode, simply making changes on the setting screen will not be effective. Complete the Test Mode in normal fashion.

Select GAME TEST MODE from the System Test Menu Screen to display the Game Test Mode Screen as follows.

Use the SERVICE Button (VIEW CHANGE button) to move the cursor to the desired test item. Press the TEST Button (START button) to enter the selected item.



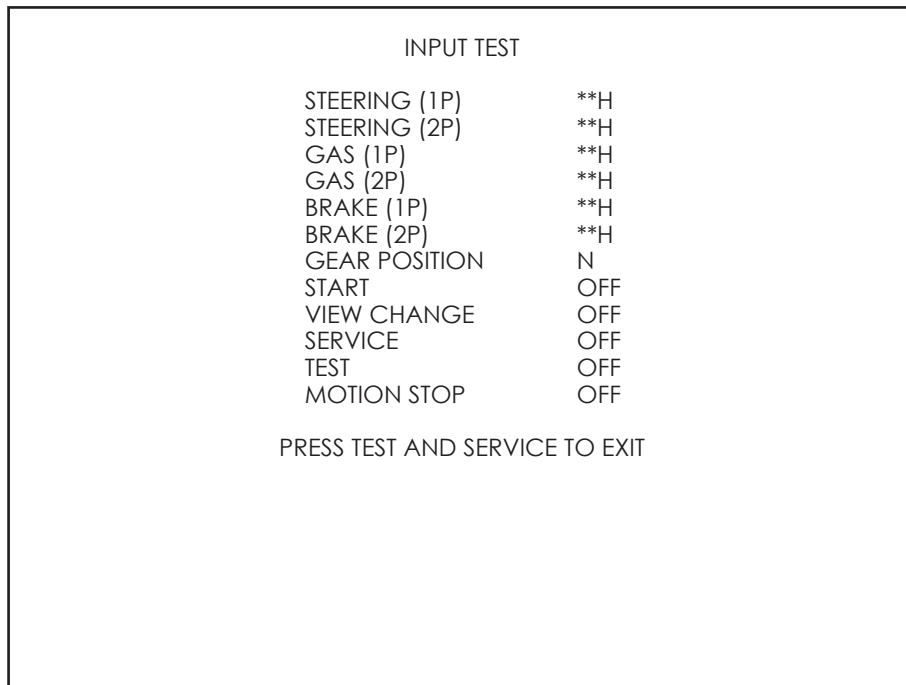
**FIG. 3-3 Game Test Mode Screen**

After the test is complete, move the cursor to EXIT and press the TEST Button to return to the System Test Menu Screen.



**A. INPUT TEST**

Select INPUT TEST to display the following screen and check the status of input devices. This test should be used periodically to check that each input device is functioning correctly.

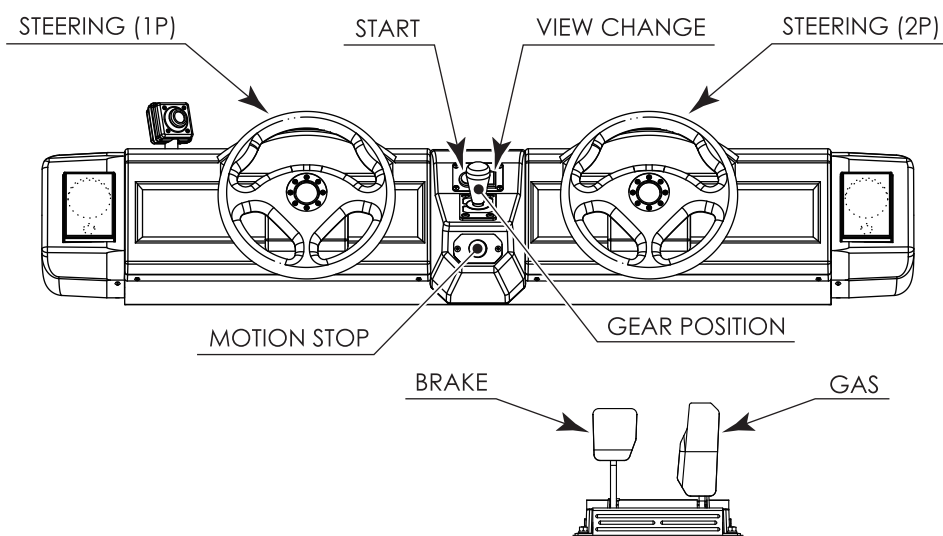


**FIG. 3-3aa Input Test Screen**

Test the STEERING, GAS, and BRAKE controls to ensure that they are functioning properly and that the parameters change smoothly as each input device is operated.

Display N, UP and DOWN using the GEAR POSITION. N displays that there is no control input. Verify that both UP and DOWN display in sync with the position of the gear shifter.

Press the START, VIEW CHANGE, MOTION STOP, SERVICE and TEST Buttons. If functioning correctly, each indicator will switch from OFF to ON.

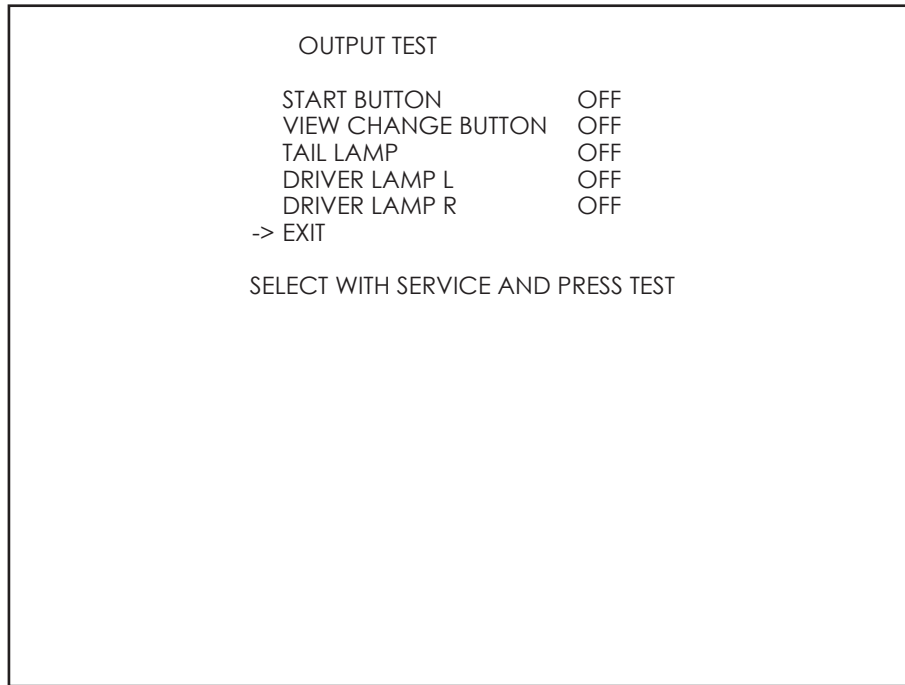


**FIG. 3-3ab**

Press the SERVICE and TEST Buttons simultaneously to return to the Game Test Mode Screen.

### B. OUTPUT TEST

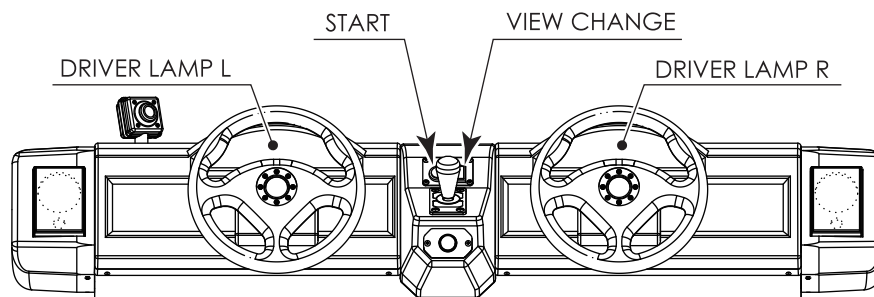
Select OUTPUT TEST to display the following screen and check the status of each lamp. Move the cursor with the SERVICE Button, and use the TEST Button to illuminate the lamp indicated by the cursor. This test should be used periodically to check that the lamps are functioning correctly.



**FIG. 3-3ba Output Test Screen**

- START BUTTON:** Lights up the START button.
- VIEW CHANGE BUTTON:** Lights up the VIEW CHANGE button.
- TAIL LAMP:** Lights up the tail lamp. (Illuminates slightly with ON, illuminates fully with ALL ON.)
- DRIVER LAMP L:** Lights up the driver lamp (left).
- DRIVER LAMP R:** Lights up the driver lamp (right).

Move the cursor to EXIT and press the TEST Button to return to the Game Test Mode Screen.



**FIG. 3-3bb**

### C. DRIVE BOARD TEST

This test allows you to check the drive board that controls the steering wheel motor and the motor. Periodically use this screen to confirm the proper operation of the drive board and motors.

Choosing and executing DRIVE BOARD TEST from the menu screen will initialize the (1) left and (2) right steering wheel motors. Until initialization is complete, do not touch the steering wheels.

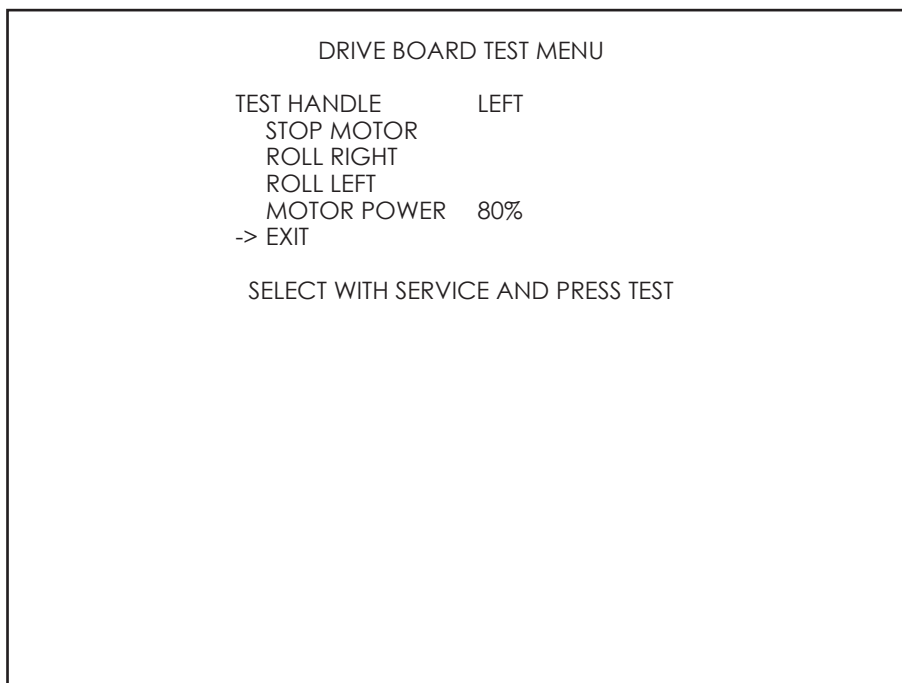
Initialization takes roughly 15 seconds to complete.



**FIG. 3-3ca Undergoing Initialization Screen**

When initialization is complete, the screen below will display, allowing for confirmation of the steering wheel motor status. Figure 3-3cb shows the test screen for the left seat.

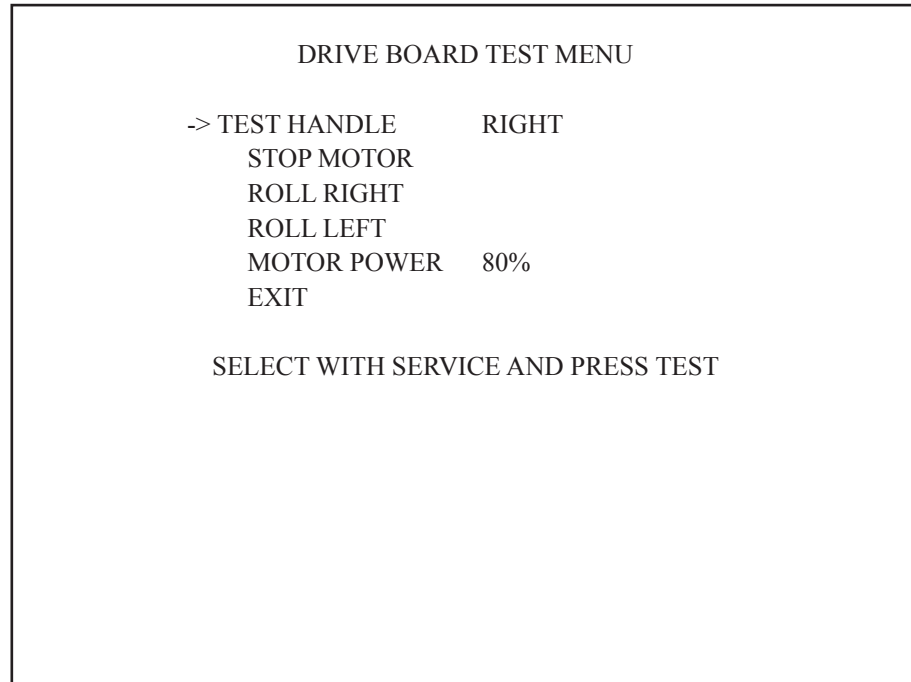
Press the SERVICE Button, move the cursor to the desired testing items, and use the TEST Button to conduct the test.



**FIG. 3-3cb Drive Board Test Menu Screen**

To test the right seat, move the cursor to TEST HANDLE and press the TEST Button. The indicator will change from “LEFT” to “RIGHT.”

In the same way, move the cursor to STOP MOTOR, ROLL RIGHT, ROLL LEFT, and MOTOR POWER, then press the Test Button to conduct the tests.



**FIG. 3-3cc Drive Board Test Menu Screen**

- TEST HANDLE:** Move the cursor to TEST HANDLE, and press the TEST Button to switch between LEFT and RIGHT.
- STOP MOTOR:** Move the cursor to STOP MOTOR, and press the TEST Button to halt the operation of the motor.
- ROLL RIGHT:** Move the cursor to ROLL RIGHT, and press the TEST Button to have the motor turn the steering wheel completely to the right.
- ROLL LEFT:** Move the cursor to ROLL LEFT, and press the TEST Button to have the motor turn the steering wheel completely to the left.
- MOTOR POWER:** Move the cursor to MOTOR POWER, and adjust the resistance setting of the steering wheel using the TEST Button. There are four levels to choose from: 100% (high resistance), 90%, 80%, and 60% (low resistance).

Move the cursor to EXIT and press the TEST Button to return to the Game Test Mode Screen.

## D. ACTUATOR CONTROL BOARD TEST

### WARNING

If a limit switch requires adjustment, request the work be done by the office listed in this manual or the point of purchase. Attempting to perform the work without specialized techniques or knowledge can result in accidents. Making improper adjustments can cause accidents during operation.

The status of each actuator and limit switch can be confirmed. Periodically use this screen to confirm the proper operation of the actuators.

However, status cannot be confirmed in the event of an “L SERVO AMP ERROR” or “R SERVO AMP ERROR”.

```
ACTUATOR CONTROL BOARD TEST

L CW LIMIT SWITCH      OFF
L CCW LIMIT SWITCH    OFF
R CW LIMIT SWITCH      OFF
R CCW LIMIT SWITCH    OFF
L ACTUATOR             ***mm
R ACTUATOR             ***mm
INITIALIZE
L ACT CW MOVE
L ACT CCW MOVE
R ACT CW MOVE
R ACT CCW MOVE
LR ACT CW MOVE
LR ACT CCW MOVE
L ACT CW R ACT CCW MOVE
L ACT CCW R ACT CW MOVE
ACTUATOR MOVE SPEED   LOW (MID /HIGH)
-> EXIT

SELECT WITH SERVICE AND PRESS TEST
```

**FIG. 3-3da Actuator Control Board Test Screen**

L represents left side, R represents right side, CW represents downward, and CCW represents upward.

## (1) Acuator Status

### L CW LIMIT SWITCH:

This displays the status of the limit switch of the actuator on the lower left side.

OFF: The limit switch is off.

ON: The limit switch is on.

It will show ON when the actuator is operated and the L actuator is at its lowest position.

### L CCW LIMIT SWITCH:

This displays the status of the limit switch of the actuator on the upper left side.

OFF: The limit switch is off.

ON: The limit switch is on.

It will show ON when the actuator is operated and the L actuator is at its highest position.

### R CW LIMIT SWITCH:

This displays the status of the limit switch of the actuator on the lower right side.

OFF: The limit switch is off.

ON: The limit switch is on.

It will show ON when the actuator is operated and the L actuator is at its lowest position.

### R CCW LIMIT SWITCH:

This displays the status of the limit switch of the actuator on the upper right side.

OFF: The limit switch is off.

ON: The limit switch is on.

It will show ON when the actuator is operated and the L actuator is at its highest position.

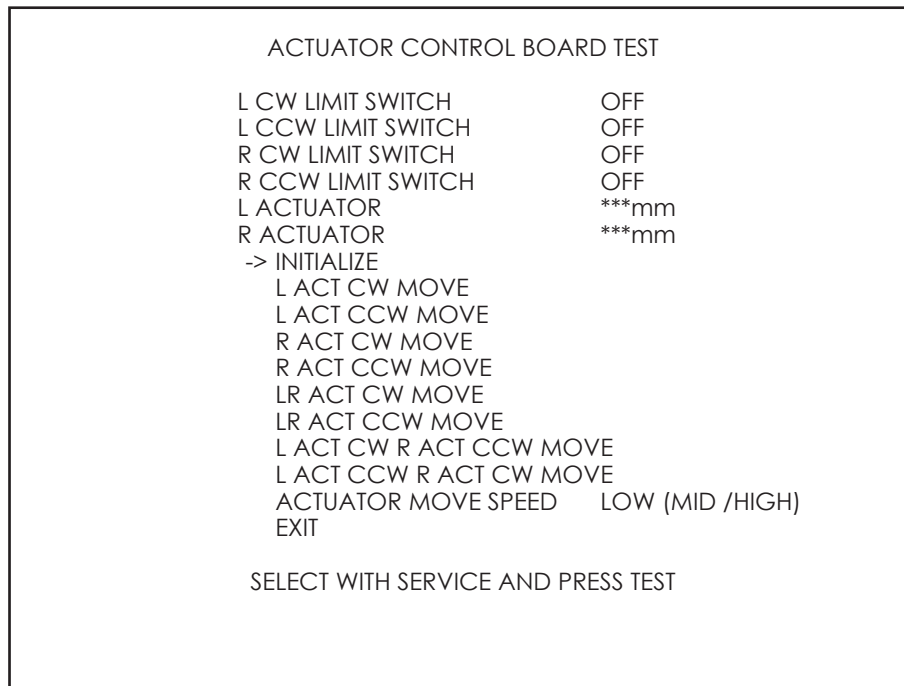
**L ACTUATOR:** Displays the current position of the left actuator.

**R ACTUATOR:** Displays the current position of the right actuator.

The tolerance zone is from 0 to 160mm. This is the distance from the detector for the CCW direction limit switch. When outside of this tolerance zone, adjustment of the limit switch is required. Also, because the value displayed is an electronic position reading, the ride's actual position and inclination could vary. Therefore, the limit switch may require adjustment even if the value displayed is within the tolerance zone.

If for example both left and right sides display 100mm, but the ride is tilted anyway, there is most likely some abnormality responsible.

If limit switch adjustment is required, request the work be done by the office listed in this manual or by the point of purchase.



**FIG. 3-3db Actuator Control Board Test Screen**

## (2) Actuator Test Operations

Once starting a procedure, the actuator will operate until it detects the limit switch. If the limit switch is not detected, the actuator will emit a very loud sound. Press the MOTION STOP button to stop the ride. Also, there may be cases where the ride is stopped due to an overload error.

When the limit switch cannot be detected, the limit switch requires adjustment. Request the work by done by the office listed in this manual or by the point of purchase.

Before the below operations are conducted, the seats return to their level position.

### INITIALIZE :

The rear of the ride will move up and down, initializing the actuator. (Time: about 20 seconds)

### L ACT CW MOVE :

The left side of the ride will go down, and the actuator's limit switch will be detected. When the limit switch is detected, the L CW LIMIT SWITCH display will show "ON," and the actuator will stop at that position.

### L ACT CCW MOVE :

The left side of the ride will go up, and the actuator's limit switch will be detected. When the limit switch is detected, the L CCW LIMIT SWITCH display will show "ON," and the actuator will stop at that position.

### R ACT CW MOVE :

The right side of the ride will go down, and the actuator's limit switch will be detected. When the limit switch is detected, the R CW LIMIT SWITCH display will show "ON," and the actuator will stop at that position.

### R ACT CCW MOVE :

The right side of the ride will go up, and the actuator's limit switch will be detected. When the limit switch is detected, the R CCW LIMIT SWITCH display will show "ON," and the actuator will stop at that position.

### LR ACT CW MOVE :

The left and right sides of the ride will go down, and the actuators' limit switches will be detected. When the limit switches are detected, the L CW LIMIT SWITCH and R CW LIMIT SWITCH displays will show "ON," and the actuators will stop at that position.

**LR ACT CCW MOVE :**

The left and right sides of the ride will go up, and the actuators' limit switches will be detected. When the limit switches are detected, the L CCW LIMIT SWITCH and R CCW LIMIT SWITCH displays will show "ON," and the actuators will stop at that position.

**L ACT CW R ACT CCW MOVE :**

The left side of the ride will go down, the right side will go up, and the actuators will detect the limit switches. When the limit switches are detected, the L CW LIMIT SWITCH and R CCW LIMIT SWITCH displays will show "ON," and the actuators will stop at that position.

**L ACT CCW R ACT CW MOVE :**

The left side of the ride will go up, the right side will go down, and the actuators will detect the limit switches. When the limit switches are detected, the L CCW LIMIT SWITCH and R CW LIMIT SWITCH displays will show "ON," and the actuators will stop at that position.

**ACTUATOR MOVE SPEED :**

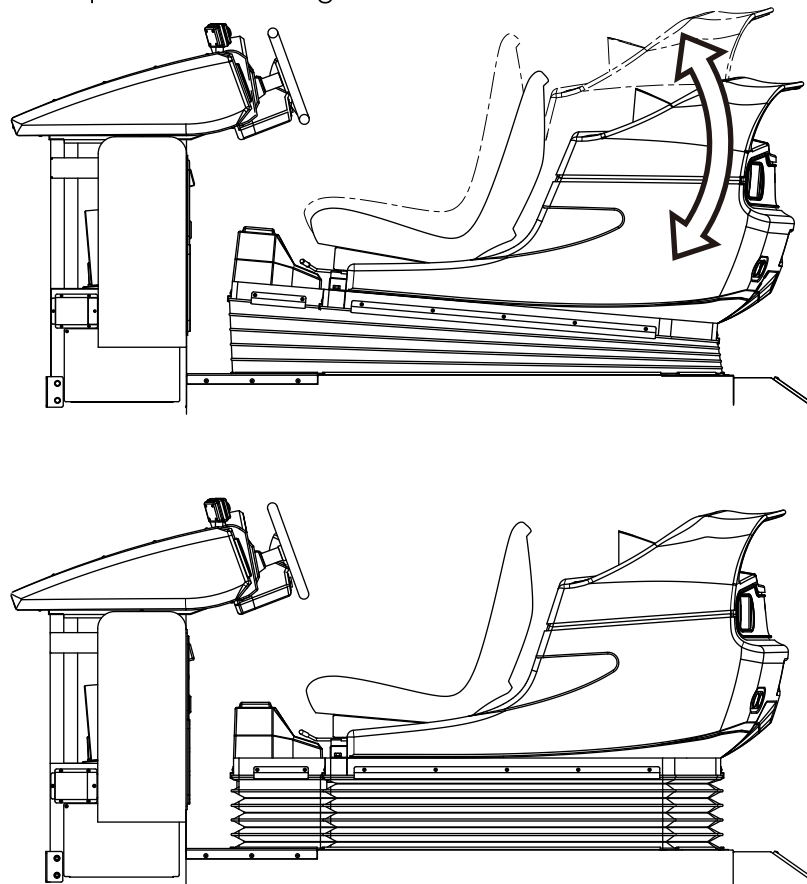
The speed of the actuators that move during testing can be set to three different levels: LOW, MID, and HIGH.

Selecting EXIT and pressing the TEST Button will return you to the Game Test Mode Screen.

If the ride is tilted because of a test, return to the Game Test Mode Screen with the ride still tilted. The ride will go through initialization operation upon exiting Test Mode, and return to a level position.

**INITIALIZE:**

The rear of the ride will move up and down to be level on the left and right, and, with the seat at a level position, the front and back of the bellows will stop at the same height.

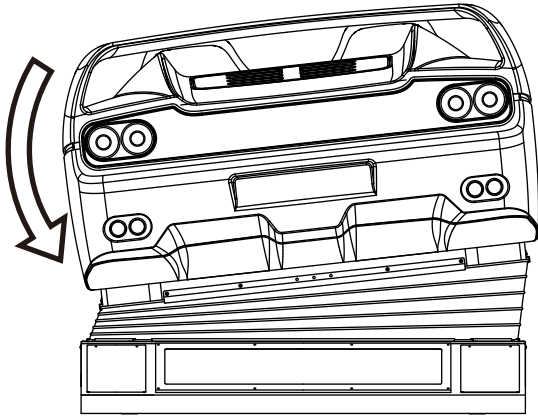


**FIG. 3-3dc01**



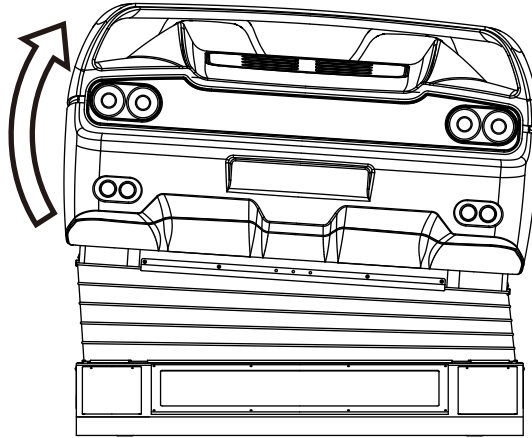
**L ACT CW MOVE:**

The left side of the ride goes down.



**L ACT CCW MOVE:**

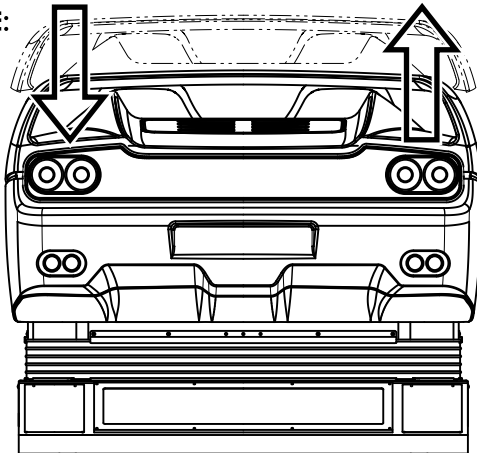
The left side of the ride goes up.



**FIG. 3-3dc02**

**LR ACT CW MOVE:**

The rear of the ride goes down.



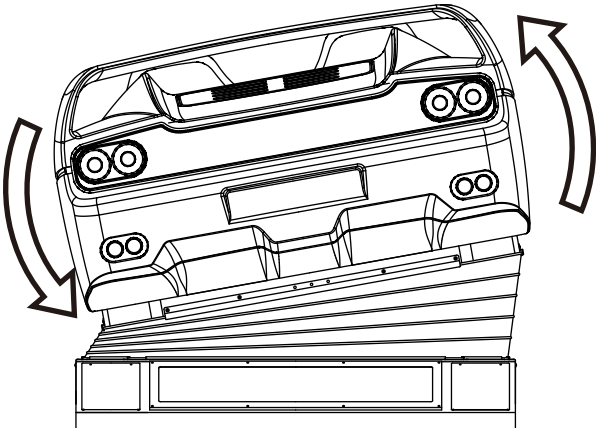
**LR ACT CCW MOVE:**

The rear of the ride goes up.

**FIG. 3-3dc03**

**L ACT CW R ACT CCW MOVE:**

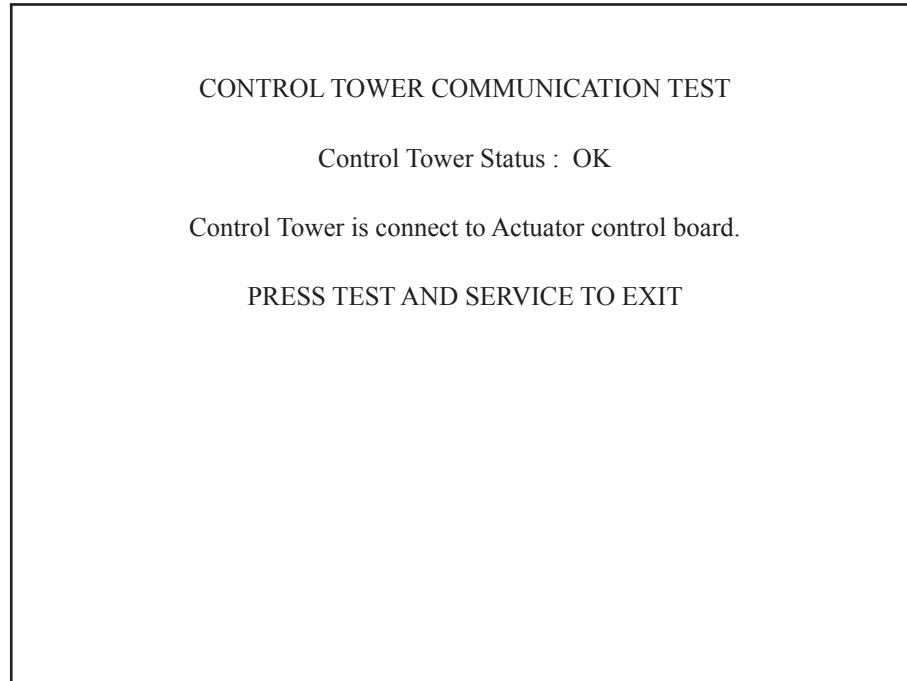
The left side of the right goes down, and the right side goes up.



**FIG. 3-3dc04**

### E. CONTROL TOWER COMMUNICATION TEST

This test allows you to confirm the status of communications with the control tower. Periodically use this screen to verify the proper operation of the control tower.



**FIG. 3-3e Control Tower Communication Test Screen**

If Control Tower Status shows “OK,” there are no abnormalities in the communications with the control tower. If “NG” is showed, please confirm the following items:

- Is the power of the tower control board turned on?
- Is the tower control board’s DIP SW set to Test Mode?  
If so, set it to standard mode.
- Is the DIP SW, which corresponds to a cockpit displaying “NG” due to the tower control board DIP SW, set to “ON”?  
If so, set the corresponding DIP SW to OFF.
- Is the wiring from the cockpit, which displays “NG”, to the control tower properly connected?  
(Confirm proper connection of the DLP coupling box connector.) (Confirm proper connection of the control tower connector.)

Press the SERVICE and TEST Buttons simultaneously to return to the Game Test Mode Screen.

## F. CALIBRATION SETTING

The screen allows you to adjust and confirm the status of the left/right steering wheels, left/right gas pedals, and left/right brake pedals. Periodically use this screen to confirm that each setting is appropriate. Also, when replacing the volume, use this screen to make adjustments.

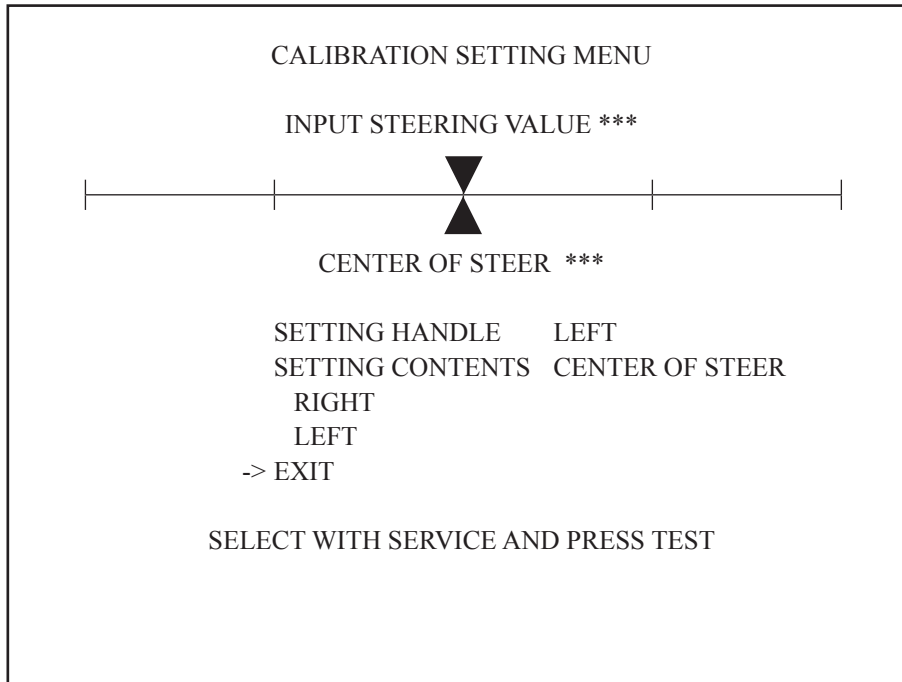


FIG. 3-3fa Calibration Setting Menu Screen

### SETTING HANDLE:

Choose LEFT or RIGHT to select the seat for calibrations by side of the ride.

### SETTING CONTENTS:

- CENTER OF STEER (Steering center value)
- MINIMUM GAS (Gas pedal lowest value)
- MAXIMUM GAS (Gas pedal highest value)
- MINIMUM BRAKE (Brake pedal lowest value)
- MAXIMUM BRAKE (Brake pedal highest value)

Can be chosen.

The above screen allows the left and right steering wheels to be adjusted.

Move the cursor to SETTING HANDLE, and switch between LEFT and RIGHT with the TEST Button. This allows you to select which side you would like to adjust.

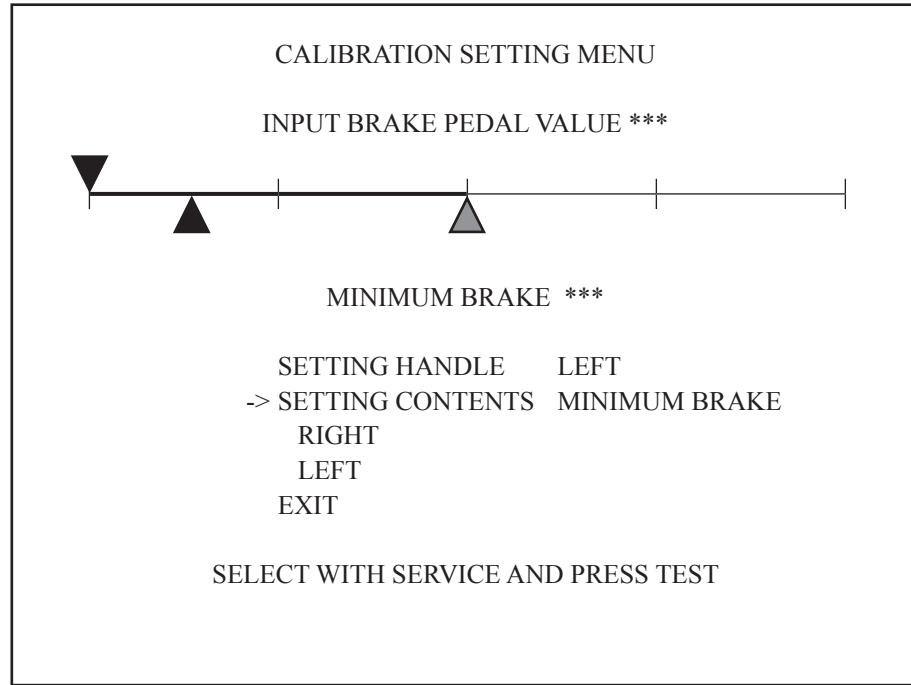
### INPUT STEERING VALUE:

Turning the steering wheel causes the ▼ to move left and right, displaying the actual steering input value (000 to 255). You can decide on a position that matches the steering wheel being in the center.

### CENTER OF STEER:

This item decides on a center position for the steering wheel. Visually align the steering wheel so it is centered.

Next, move the ▲ so it lines up with the ▼ by moving the cursor to RIGHT or LEFT and pressing the TEST Button. Decide on a center value for the steering by moving to the right with RIGHT, or LEFT with left. The settings will be applied when you move to a different item.



**FIG. 3-3fb Calibration Setting Menu Minimum Brake Screen**

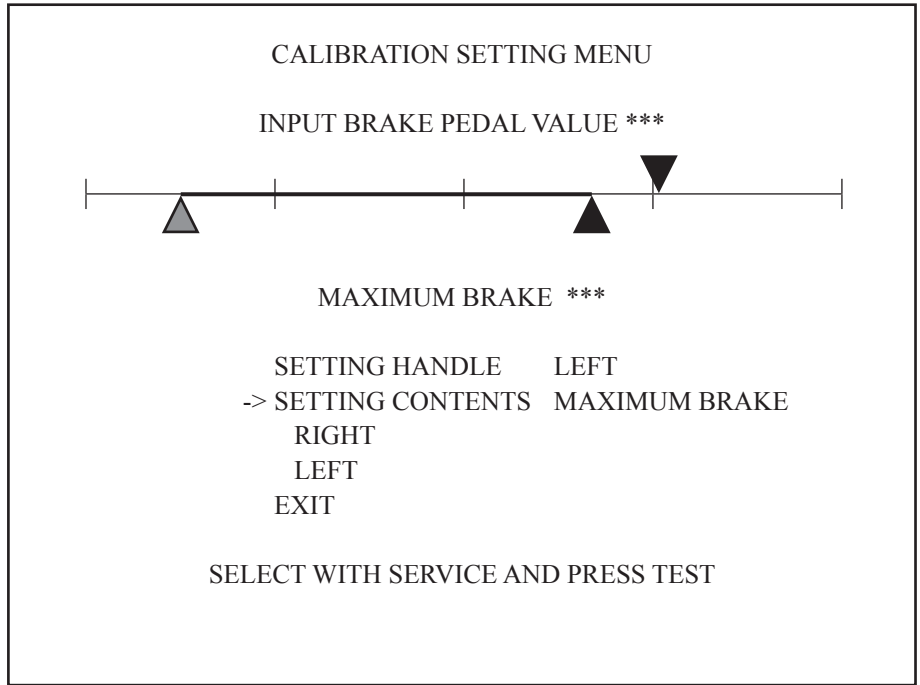
This screen allows you to adjust the minimum values for the left and right brake pedals. Move the cursor to SETTING CONTENTS, and use the TEST Button to select MINIMUM BRAKE.

**INPUT BRAKE PEDAL VALUE:**

Stepping on the brake pedal will move the ▼ to the left or right, displaying the actual brake pedal input value.

**MINIMUM BRAKE:**

As shown on the screen, set the ▲ to the right of the ▼, which represents the point when pressure is no longer applied to the brake pedal. The leftmost ▲ represents the value where the brake will actually begin functioning. The leftmost ▲ can be moved to the right or left with RIGHT or LEFT.



**FIG. 3-3fc Calibration Setting Menu Maximum Brake Screen**

This screen allows you to adjust the maximum values for the left and right brake pedals. Move the cursor to SETTING CONTENTS, and select MAXIMUM BRAKE with the TEST Button.

**INPUT BRAKE PEDAL VALUE:**

Stepping on the brake pedal will move the ▼ to the left or right, displaying the actual brake pedal input value.

**MAXIMUM BRAKE:**

As shown on the screen, set the ▲ to the left of the ▼, which represents the maximum pressure applied to the brake pedal. The leftmost ▲ represents the value where the brake will actually begin functioning. The area between the leftmost ▲ and rightmost ▲ represents the area and value where the brake functions, and therefore, the width between the ▲ and ▲ should be set within the width of ▼. The rightmost ▲ can be moved to the right or left with RIGHT or LEFT.

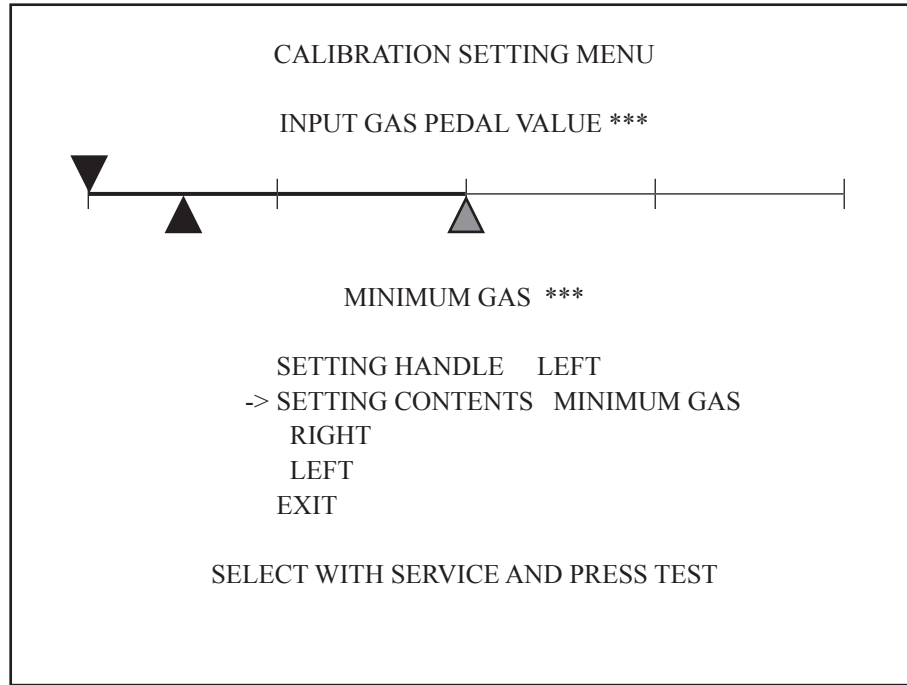


FIG. 3-3fd Calibration Setting Menu Minimum Gas Screen

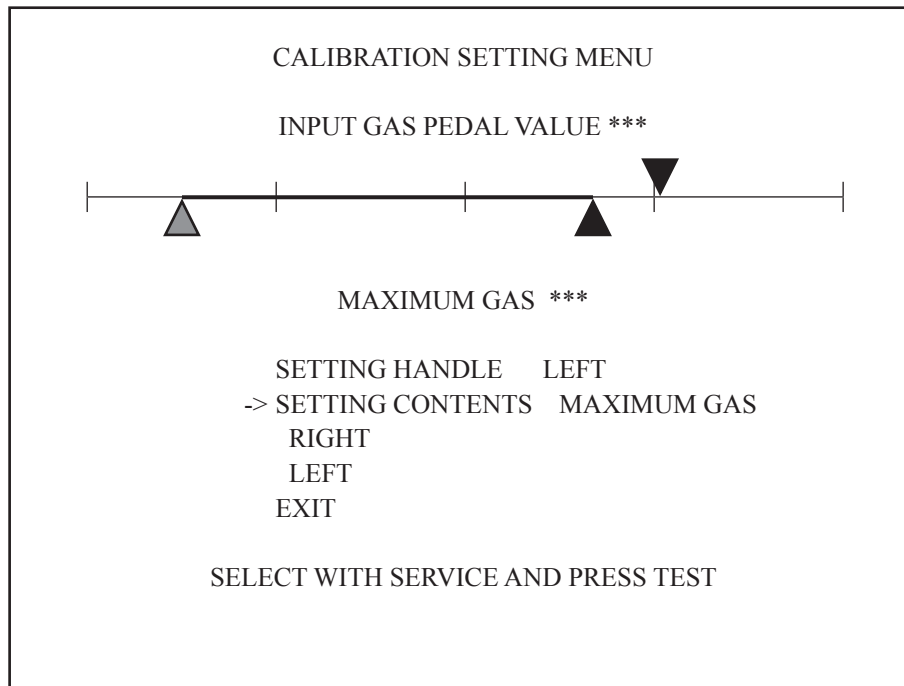
This screen allows you to adjust the minimum values for the left and right gas pedals. Move the cursor to SETTING CONTENTS, and select MINIMUM GAS with the TEST Button.

**INPUT GAS PEDAL VALUE:**

Stepping on the gas pedal will move the ▼ to the left or right, displaying the actual gas pedal input value.

**MINIMUM GAS:**

As shown on the screen, set the ▲ to the right of the ▼, which represents the point when pressure is no longer applied to the gas pedal. The leftmost ▲ represents the value where the gas will actually begin functioning. The leftmost ▲ can be moved to the right or left with RIGHT or LEFT.



**FIG. 3-3fe Calibration Setting Menu Maximum Gas Screen**

This screen allows you to adjust the maximum values for the left and right gas pedals. Move the cursor to SETTING CONTENTS, and select MAXIMUM GAS with the TEST Button.

**INPUT GAS PEDAL VALUE:**

Stepping on the gas pedal will move the ▼ to the left or right, displaying the actual gas pedal input value.

**MAXIMUM GAS:**

As shown on the screen, set the ▲ to the left of the ▼, which represents the maximum pressure applied to the gas pedal. The leftmost ▲ represents the value where the gas pedal will actually begin functioning. The area between the leftmost ▲ and rightmost ▲ represents the value and area where the gas pedal functions, and therefore, the width between the ▲ and ▲ should be set within the width of ▼.

The rightmost ▲ can be moved to the right or left with RIGHT or LEFT.

After changing the settings, select EXIT and press the TEST Button to return to the Game Test Mode Screen.

### G. GAME ASSIGNMENTS

This screen allows you to set game difficulty and network play settings, etc. Settings will not be applied until EXIT is chosen on the Game Test Mode Screen. If these settings are changed, be sure to exit Game Test Mode.

Press the SERVICE Button to move the cursor to the item that you want to change, and use the TEST Button to select the item to be changed.

When adjusting settings for network play (DIFFICULTY, ADVERTISE SOUND, SPEED METER, QUICKSTART, and 15 COURSE MODE), settings will correspond to the settings of the cabinets whose LINK\_ID is "1." Just because the in-game displays and settings change, the test settings themselves will not necessarily change.

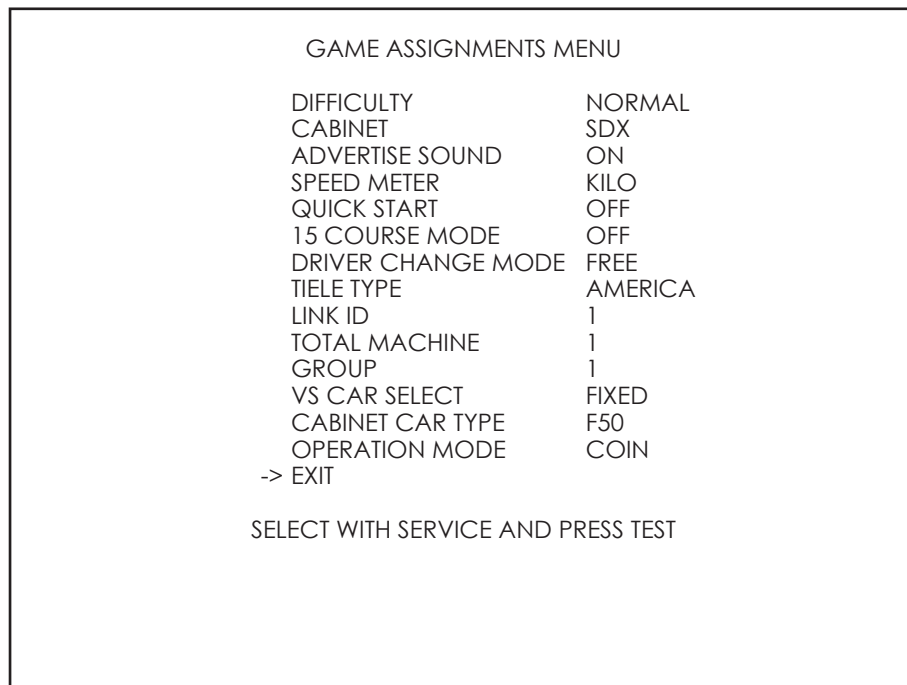


FIG. 3-3ga Game Assignments Menu Screen



|                            |  |
|----------------------------|--|
| <b>DIFFICULTY:</b>         | The game difficulty setting. There are 5 difficulty levels with VERY EASY being the easiest setting and VERY HARD being the most difficult setting.  |
| <b>CABINET:</b>            | The cabinet type setting. SDX and DX can be chosen. This product, with four cars for network play, is set to SDX.  |
| <b>ADVERTISE SOUND:</b>    | The setting to turn the advertising sound ON/OFF.  |
| <b>SPEED METER:</b>        | The speed display setting. During game play, KILO will be displayed as “km/h”, and MILE as “mph”.  |
| <b>QUICK START:</b>        | Choosing ON will cause the game to advance to the Selector Screens as soon as the credits necessary for starting are inserted.   |
| <b>15 COURSE MODE:</b>     | The setting for 15-Continuous Course Mode. Compared with the standard game mode, the play time is longer.<br>If set to OFF, 15-Continuous Course Mode cannot be played.<br>With ON CHARGE, 15-Continuous Course Mode can be played. Setup for additional credits can be found in System Test Mode’s COIN ASSIGNMENTS under GAME COST SETTING.<br>With ON FREE, 15-Continuous Course Mode can be played without additional credits. (See LINDBERGH service manual.) |
| <b>DRIVER CHANGE MODE:</b> | Choose FREE or CHARGE.<br>FREE allows selection without additional credits.<br>CHARGE requires additional credits. Setup for additional credits can be found in System Test Mode’s COIN ASSIGNMENTS under GAME COST SETTING.   |
| <b>TITLE TYPE:</b>         | The setting for the Title Screen type. AMERICA shows the American flag, and CLOUD shows clouds.  |
| <b>LINK_ID:</b>            | The setting for the cabinet player numbers. Set a different number for each unit within the group. Do not set the same numbers within a group. If using network play, LINK_ID, TOTAL MACHINE, and GROUP must be set on each cabinet independently.   |
| <b>TOTAL MACHINE:</b>      | The number of network connected game cabinets. Sets the number of competing cabinets in Versus Mode. Setting this to “1” limits possible play modes to Single Player Mode only.  |
| <b>GROUP:</b>              | Used for dividing networked cabinets into groups. For example, to split up a group of four networked machines into two groups of two cabinets, set two cabinets to “1” and the other two cabinets to “2”.  |

**[SDX Network Play Setup Example]**

There are four cabinets: A, B, C, and D. They are all connected with network cables.

Four car network play (Recommended setting: Use these settings during normal operation.)

|               |                                |                  |                  |                |
|---------------|--------------------------------|------------------|------------------|----------------|
| CABINET       | F50 (red)                      | Dino246 (yellow) | 360Spider (blue) | 512BB (silver) |
| LINK ID       | 1                              | 2                | 3                | 4              |
| TOTAL MACHINE | 4                              | 4                | 4                | 4              |
| GROUP         | 1                              | 1                | 1                | 1              |
| Status        | Four car network play possible |                  |                  |                |

Three car network play (When one cabinet has broken down)

|               |                        |                                 |                  |                |
|---------------|------------------------|---------------------------------|------------------|----------------|
| CABINET       | F50 (red)              | Dino246 (yellow)                | 360Spider (blue) | 512BB (silver) |
| LINK ID       | 1                      | 1                               | 2                | 3              |
| TOTAL MACHINE | 1                      | 3                               | 3                | 3              |
| GROUP         | 1                      | 2                               | 2                | 2              |
| Status        | Single Player Mode car | Three car network play possible |                  |                |

Two car network play (When two cabinets have broken down)

|               |                               |                  |                               |                |
|---------------|-------------------------------|------------------|-------------------------------|----------------|
| CABINET       | F50 (red)                     | Dino246 (yellow) | 360Spider (blue)              | 512BB (silver) |
| LINK ID       | 1                             | 2                | 1                             | 2              |
| TOTAL MACHINE | 2                             | 2                | 2                             | 2              |
| GROUP         | 1                             | 1                | 2                             | 2              |
| Status        | Two car network play possible |                  | Two car network play possible |                |

No network play (All cabinets operate independently)

|               |                        |                        |                        |                        |
|---------------|------------------------|------------------------|------------------------|------------------------|
| CABINET       | F50 (red)              | Dino246 (yellow)       | 360Spider (blue)       | 512BB (silver)         |
| LINK ID       | 1                      | 1                      | 1                      | 1                      |
| TOTAL MACHINE | 1                      | 1                      | 1                      | 1                      |
| GROUP         | 1                      | 1                      | 1                      | 1                      |
| Status        | Single Player Mode car | Single Player Mode car | Single Player Mode car | Single Player Mode car |

**VS CAR SELECT:**

FIXED allows the CABINET CAR TYPE listed in the menu below to be selected, and sets that car as the player's car to be used during network play. (E.g.: F50 (1P) can only use the F50.) With SELECTABLE, the player cars can be chosen at will. However, the color cannot be chosen.

**CABINET CAR TYPE:**

This setting can only be changed when VS CAR SELECT is set to FIXED. It allows you to set the player car used by each cabinet.

**OPERATION MODE:**

TICKET1, TICKET2, and COIN can be selected.  
 With TICKET 1 and TICKET 2, game is operated by an attendant from the control tower. CREDIT will not be displayed. For the differences between TICKET1 and TICKET2, see TABLE 1-2.  
 With the COIN setting, players insert coins to play the game, like a normal video game.

**STOP IMPORTANT**

Operate this product using the four car network play setup shown below. Only when there is a problem preventing the usage of a cabinet should the settings be changed to those described above.

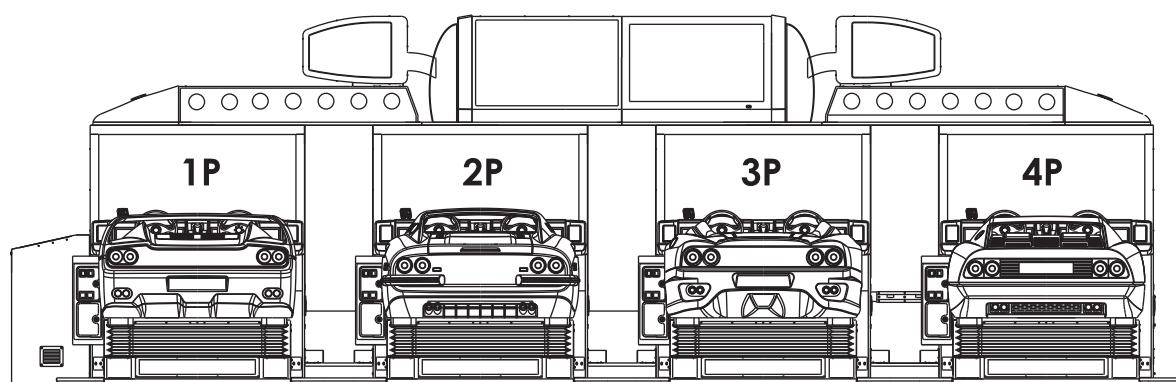


FIG. 3-3gb Cabinet Setup

| CABINET CARS       | F50 (red) | DINO246 (yellow) | 360SPIDER (blue) | 512BB (silver) |
|--------------------|-----------|------------------|------------------|----------------|
| DIFFICULTY         | NORMAL    | NORMAL           | NORMAL           | NORMAL         |
| CABINET            | SDX       | SDX              | SDX              | SDX            |
| ADVERTISE SOUND    | ON        | ON               | ON               | ON             |
| SPEED METER        | KILO      | KILO             | KILO             | KILO           |
| QUICK START        | OFF       | OFF              | OFF              | OFF            |
| 15 COURSE MODE     | OFF       | OFF              | OFF              | OFF            |
| DRIVER CHANGE MODE | CHARGE*1  | CHARGE           | CHARGE           | CHARGE         |
| TITLE TYPE         | AMERICA   | AMERICA          | AMERICA          | AMERICA        |
| LINK_ID            | 1         | 2                | 3                | 4              |
| TOTAL MACHINE      | 4         | 4                | 4                | 4              |
| GROUP              | 1         | 1                | 1                | 1              |
| VS CAR SELECT      | FIXED     | FIXED            | FIXED            | FIXED          |
| CABINET CAR TYPE   | F50       | Dino246          | 360 SPIDER       | 512BB          |
| OPRERATION MODE    | COIN      | COIN             | COIN             | COIN           |

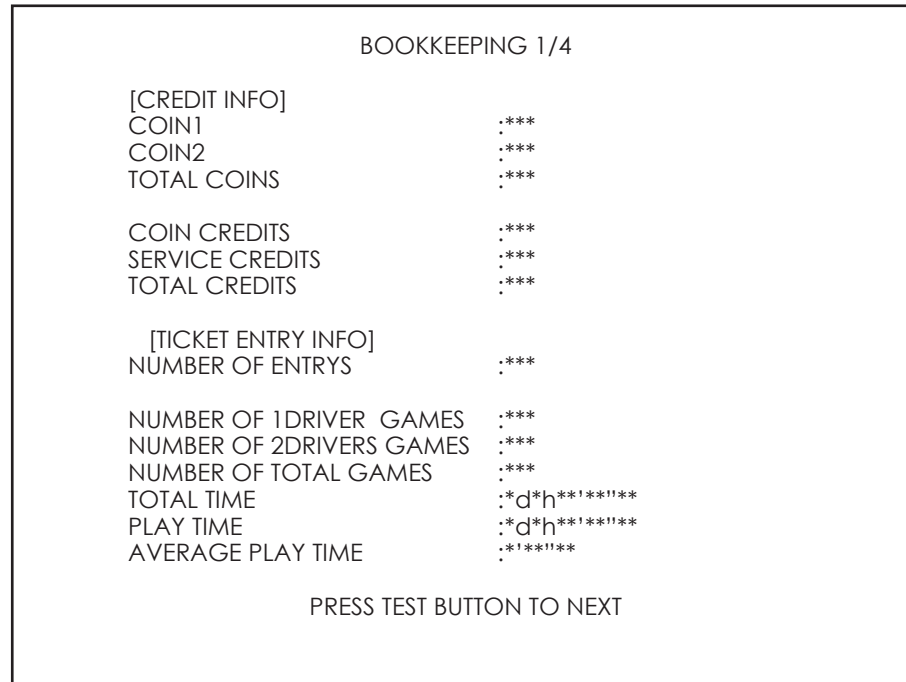
\*1: Setup for additional credits can be found in System Test Mode's COIN ASSIGNMENTS under GAME COST SETTING. (See LINDBERGH service manual.)

Select EXIT and press the TEST Button to return to the Game Test Mode Screen.

## H. BOOKKEEPING

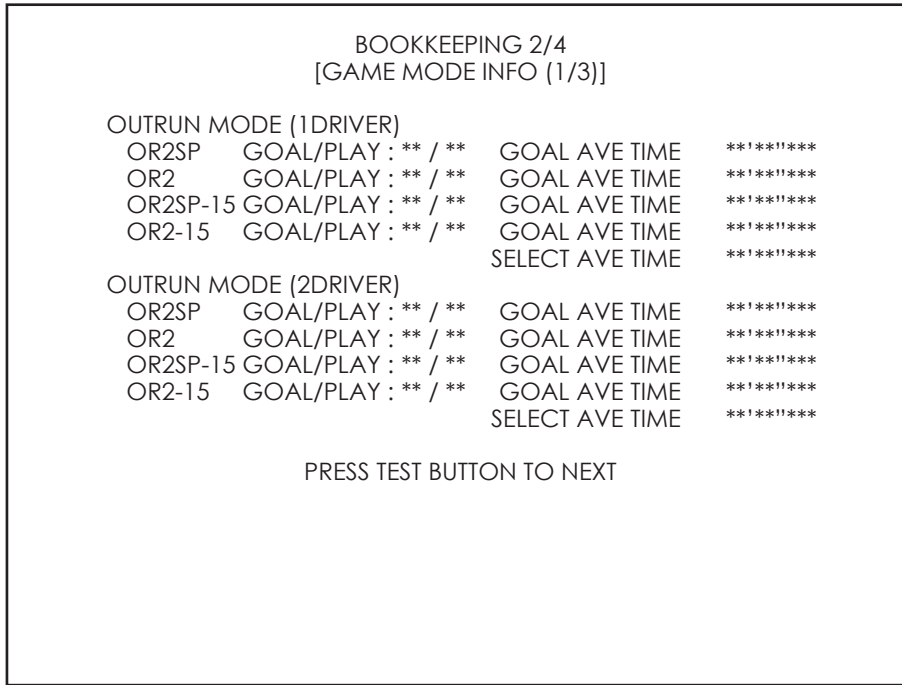
Four screens show the operational data up until the present.

Press the TEST Button to advance to the next screen. Pressing the TEST Button while on the fourth screen will return you to the Game Test Mode Screen.



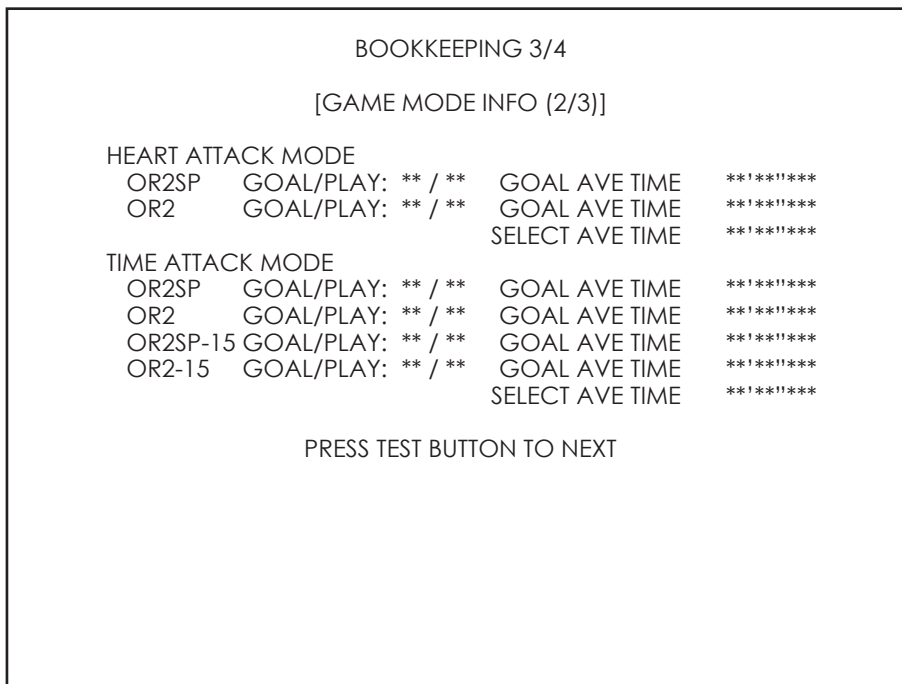
**FIG. 3-3ha Bookkeeping (1/4) Screen**

|                                  |  |
|----------------------------------|--|
| <b>COIN1:</b>                    | The number of coins inserted into coin slot 1.               |
| <b>COIN2:</b>                    | The number of coins inserted into coin slot 2.               |
| <b>TOTAL COINS:</b>              | The total number of coins inserted into the coin slots.      |
| <b>COIN CREDITS:</b>             | The number of credits for the coins inserted.                |
| <b>SERVICE CREDITS:</b>          | The number of credits input by the SERVICE Button.           |
| <b>TOTAL CREDITS:</b>            | Total credits from coins and the SERVICE Button.             |
| <b>NUMBER OF ENTRYS:</b>         | The number of ticket entries input at the control tower.     |
| <b>NUMBER OF 1DRIVER GAMES:</b>  | The number of games played using “1 Driver.”                 |
| <b>NUMBER OF 2DRIVERS GAMES:</b> | The number of games played using “2 Drivers.”                |
| <b>NUMBER OF TOTAL GAMES:</b>    | The combined number of “1 Driver” and “2 Drivers” games.     |
| <b>TOTAL TIME:</b>               | The amount of time the unit has been in operation.           |
| <b>PLAY TIME:</b>                | Total playing time.  |
| <b>AVERAGE PLAY TIME:</b>        | Total play time divided by the total number of games played. |



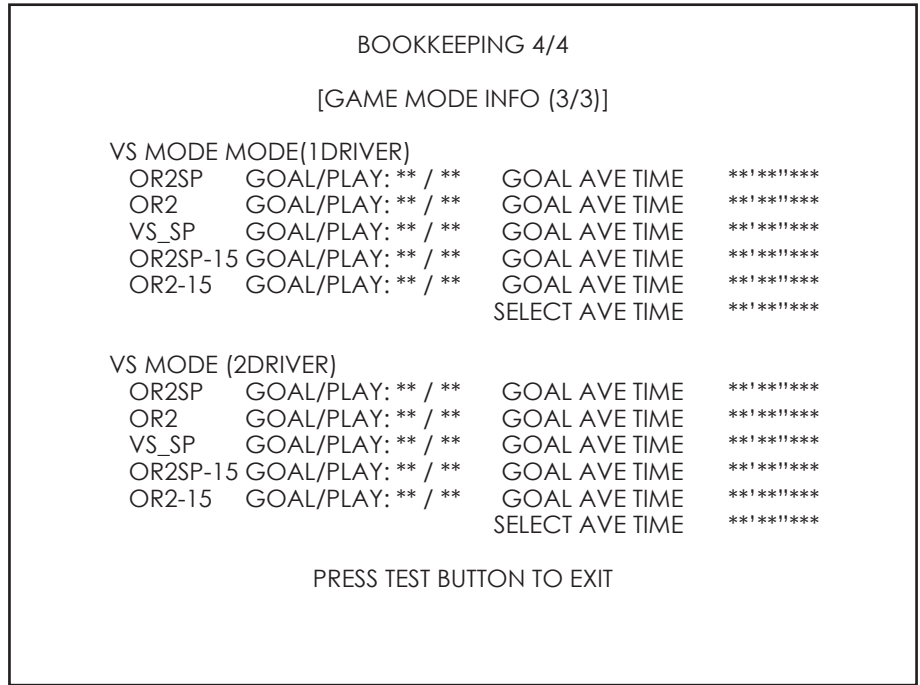
**FIG. 3-3hb Bookkeeping (2/4) Screen**

This screen shows “1 Driver” and “2 Drivers” goal counts, play counts, and average goal time by course for OutRun Mode. Use these as a guideline for the difficulty settings.



**FIG. 3-3hc Bookkeeping (3/4) Screen**

This screen shows goal counts, play counts, and average goal time by course in Heart Attack Mode and Time Attack Mode. Use these as a guideline for the difficulty settings.



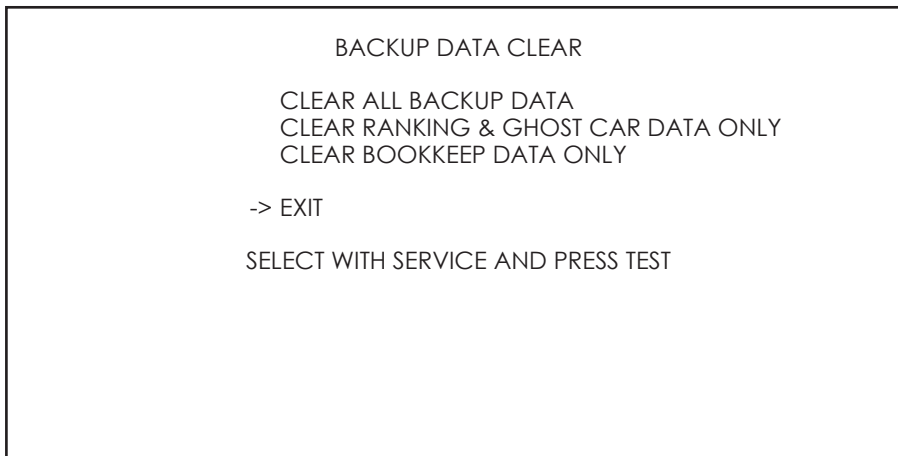
**FIG. 3-3hd Bookkeeping (4/4) Screen**

This screen shows “1 Driver” and “2 Drivers” goal counts, play counts, and average goal time by course in Versus Mode. Use these as an approximation for the difficulty settings.

Press the TEST Button to return to the Game Test Mode Screen.

## I. BACKUP DATA CLEAR

Select BACKUP DATA CLEAR to display the following screen, and you can clear the bookkeeping data, top score ranking data, or coin/credit related data.



**FIG. 3-3ia Backup Data Clear Screen**

Select the data to clear.

### **CLEAR ALL BACKUP DATA:**

Initializes all of the data.

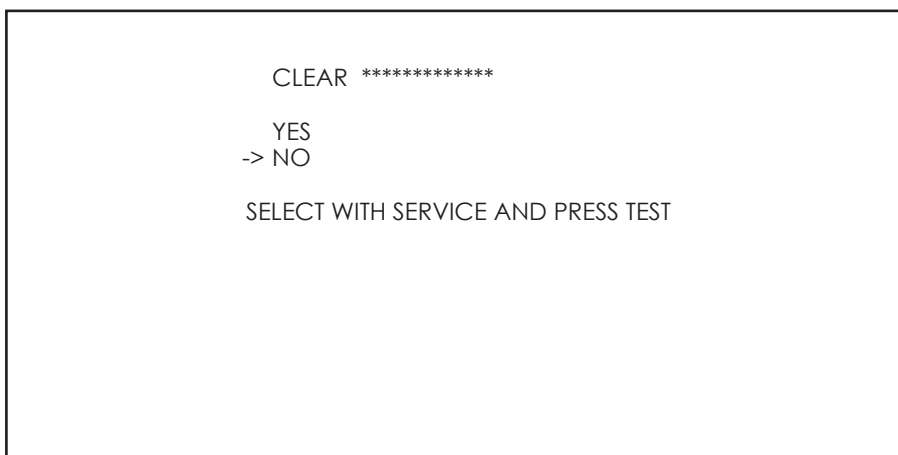
### **CLEAR RANKING & GHOST CAR DATA ONLY:**

Only initializes the ranking and ghost car data.

### **CLEAR BOOKKEEP DATA ONLY:**

Only initializes the bookkeeping data.

Use the SERVICE Button to move the cursor to the item corresponding to the data to clear, then press the TEST Button. The following confirmation screen is displayed.



**FIG. 3-3ib Backup Data Clear Confirmation Screen**

To clear data, use the SERVICE Button to move the cursor to YES (CLEAR) and then press the TEST Button. When the data has been cleared, the message "COMPLETED" will be displayed.

Press the TEST Button again to return to the Game Test Mode Screen.

Move the cursor to NO (CANCEL) and press the TEST Button to return to the Game Test Mode Screen without clearing the data.

Using the functions of this screen to clear backup data will not clear GAME ASSIGNMENTS settings. Press the TEST Button to return to the Game Test Mode Screen.

## 4 TOWER AND BILLBOARD TEST MODE

### 4-1 TOWER CONTROL BOARD

#### **⚠ WARNING**

- When changing the settings of the DIP SWs, always turn off the power before flipping the DIP SWs. Failure to follow this precaution can result in electric shocks and short circuits.
- When restoring power after flipping the DIP SWs, confirm that there are no persons in the area of the ride. When power is restored, the ride will go through initialization operation. Failure to follow this precaution can result in major or minor collisions or falls.

#### **⚠ CAUTION**

- Be careful not to get fingers caught when removing or attaching the front door.
- The tower control board is inside the tower. Be careful not to get injured by any of the components inside the tower.

#### **STOP IMPORTANT**

- After flipping the DIP SWs, the settings will take effect when power is restored. Flipping the DIP SWs while the power is still on will have no effect.
- Prepare auxiliary lighting such as a flashlight when flipping the DIP SWs. The tower control board is inside the tower, and, because the DIP SWs are small, errors can easily be made.

The tower control board is found at the top right inside the front of the control tower, if the front door is open.

- 1 Turn off the power. (See 1-3.)
- 2 Remove the two truss screws that fasten the front door.

TRUSS SCREW (2), black  
M4×8



FIG. 4-1a

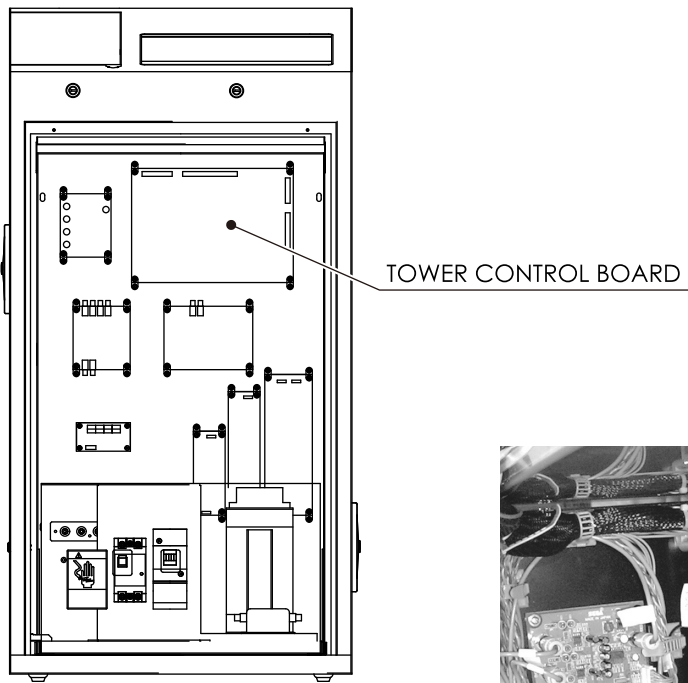


**3** Unlock the front door with the master key, and remove it.

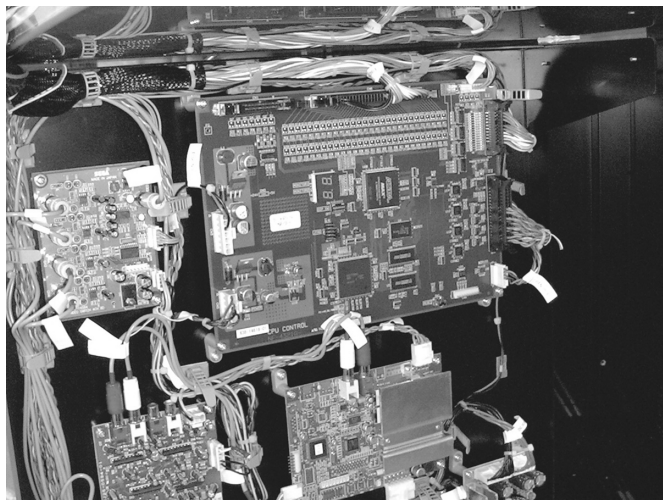


**FIG. 4-1b**

**4** The tower control board is at the top right inside the front of the control tower.



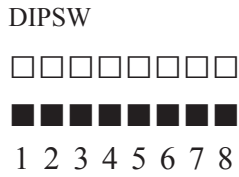
**FIG. 4-1c Control Board**



**FIG. 4-1d**

**[Tower Control Board DIP SW]**

The tower control board has DIP SWs.  
Normally, all are set to OFF.



**FIG. 4-1e**

DIP SW Number Table:

- 1: Mode Switch (Normally not needed. Set it to OFF.)
- 2: Mode Switch (Used for Tower and Billboard Test Mode.)
- 3: Mode Switch (Normally not needed. Set it to OFF.)
- 4: Mode Switch (Normally not needed. Set it to OFF.)
- 5: Cockpit 1P (Recognized as active when OFF.)
- 6: Cockpit 2P (Recognized as active when OFF.)
- 7: Cockpit 3P (Recognized as active when OFF.)
- 8: Cockpit 4P (Recognized as active when OFF.)

**[When operating with 3 or less cockpits]**

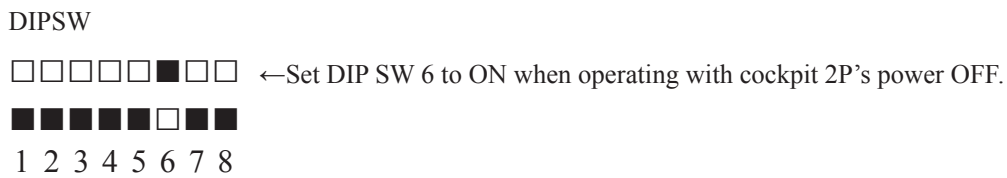
In the event that a cockpit (cabinet) cannot operate due to some sort of problem, use the tower control board to setup operation for 3 cockpits.

DIP SW 5 through 8 correspond to cockpits 1P through 4P.

If, for example, cockpit 2P is unable to operate, turn off the power to cockpit 2P, and, if operating using the three remaining units, set the DIP SW as shown below.

Flip the number 6 DIP SW to ON, and turn on the power to the control tower. This enables the remaining three units to operate.

The billboard will display for the remaining 3 units.

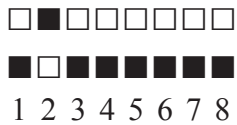


**FIG. 4-1f**

## 4-2 TOWER AND BILLBOARD TEST MODE

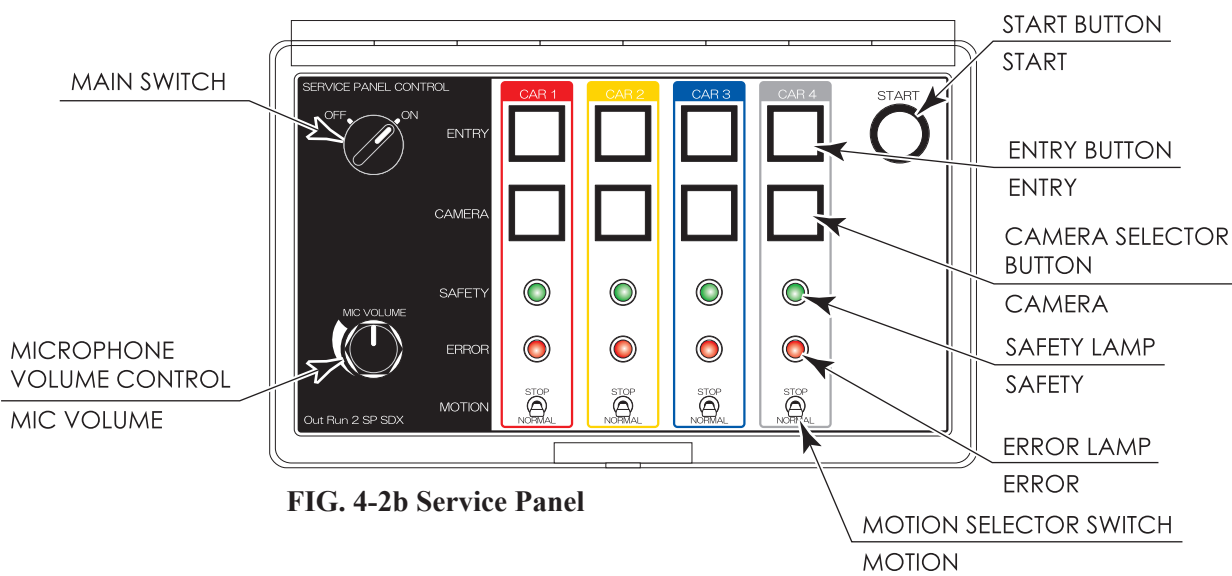
By turning the tower control board's DIP SW 2 to ON, you can conduct tests of the control tower and billboard when turning on product's power.

DIPSW



**FIG. 4-2a**

Flipping the switch on the control tower's service panel allows you to conduct the checks below.



**FIG. 4-2b Service Panel**

● **Main switch**

When OFF, any input from the switches is cancelled, so nothing will happen even if other switches are pressed. Check that this is ON when in Test Mode.

● **ENTRY button**

Each ENTRY button will illuminate when pressed. The ranking board's LED display on the billboard will change to match the ENTRY button that has been pressed. The color of the car display on the ranking board will change whenever the button is pressed, and, finally, the LED display that responded will extinguish.

**Ranking Board**

- 1st Car Picture Arrow ← Will illuminate when ENTRY button 1 is pressed.
- 2nd Car Picture Arrow ← Will illuminate when ENTRY button 2 is pressed.
- 3rd Car Picture Arrow ← Will illuminate when ENTRY button 3 is pressed.
- 4th Car Picture Arrow ← Will illuminate when ENTRY button 4 is pressed.

● **CAMERA selector button**

The CAMERA selector buttons will illuminate while pressed. The CCD camera video feed corresponding to the cabinet number whose button was pressed will be displayed on the LCD monitor.

● **MOTION selector switch**

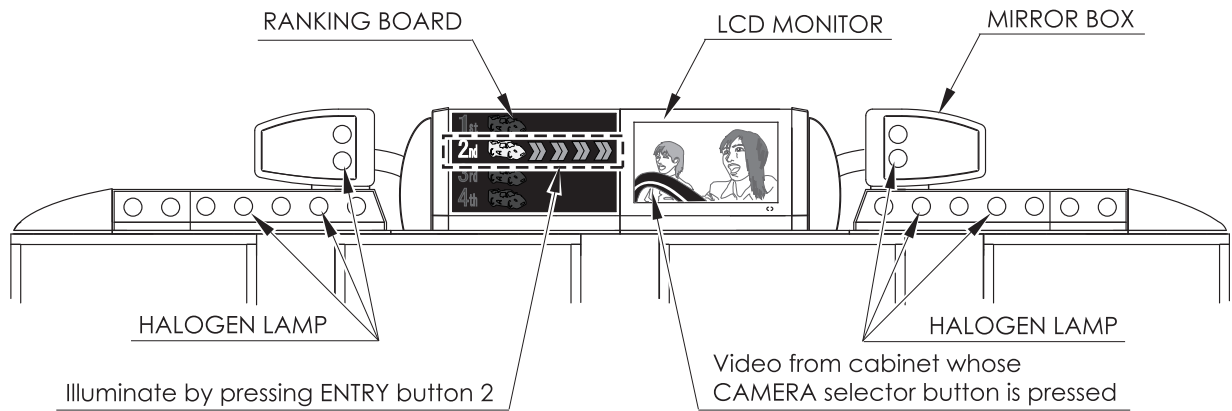
The corresponding safety lamp will illuminate when each switch is set to STOP (up), and the corresponding error lamp will illuminate when each switch is set to MOVE (down).

- **START button**

The START button will illuminate while pressed.

All of the halogen lamps on the billboard will illuminate when the START button is pressed.

The halogen lamps will extinguish when the button is pressed again.



**FIG. 4-2c Billboard**

## 4-3 SETTINGS FOR WHEN 1 OR MORE UNITS HAVE BROKEN DOWN

This section explains the settings to use when a cabinet cannot be used because of some sort of malfunction. The following procedure explains how to change the settings from 4-unit network play to 3-unit network play, for situations where 1 unit has broken down.

- 1** Turn off all power (control tower power). (See 1-3.)
- 2** Turn off the power switch of the cabinet with the malfunction. The switch is on the left side of the DLP base.
- 3** Change the DIP SW settings on the tower control board inside the control tower. The DIP SWs numbered 5, 6, 7, and 8 correspond to 1P, 2P, 3P, and 4P, respectively. Flip the DIP SW of the malfunctioning cabinet to ON. Ordinarily, it is set to OFF.
- 4** Turn on the control tower's power. Restore power to cabinets without malfunctions. Because the units are configured for 4-unit network play, but 1 unit does not have power, the network check message will continue to display on the screens after initialization operation.
- 5** Put the cabinets that have power into Test Mode.
- 6** Adjust settings for 3-unit network play at the Game Setting Screen.  
Set TOTAL MACHINE to 3.  
Set the LINK ID of the cabinets, from the left, to 1, 2, and 3.
- 7** Exit Test Mode. After initialization operation and network check, the 3 units will display the Customer Welcome Screen, indicating that setup is complete.

## 5 ERROR DISPLAY

### WARNING

- If there is an error display, search out the cause immediately and take corrective action. If the product is operated while the error is ignored, there could be an accident. There could also be permanent damage to parts, etc.
- If an error is displayed, have the site maintenance personnel or other qualified individuals resolve it. If someone without specialized or technical knowledge attempts to rectify the problem, electric shock, short circuits or fire may result. If there is no site maintenance personnel or other qualified individuals available, turn the power off immediately, and contact your retailer or the office listed in this manual.
- If a problem not described in this manual and the LINDBERGH service manual occurs, or the resolution to a problem described in this manual is not effective, do not make further attempts to resolve the problem yourself. Immediately turn off the power and contact your retailer or the office listed in this manual. Any unguided attempts to solve such problems may lead to a serious accident.
- If countermeasures given in this manual have been taken and there are still no improvements, contact the point of purchase or the office indicated in these instructions.
- In the event that parts related to the ride mechanisms (actuators, limit switches, etc.) are damaged or break down, or when parts replacement or repairs are needed, request work be done by the point of purchase or the office listed in this manual. Such procedures require specialized knowledge, techniques, and tools. Improperly performed procedures can result in accidents.

To respond to various problems, error messages appear on the screen whenever an error has occurred. If an error message is displayed, the game cannot be played.

Errors are grouped into the following two categories.

(1) Error 01~52: These are errors on the LINDBERGH. For details, read the LINDBERGH service manual.

(2) Message Display: These errors are unique to this product.

#### **Drive board is not connected to main board.**

The driver board could not be detected.

Check the wiring between the drive board and LINDBERGH, and the power to the drive board.

#### **Drive board : Original point error**

Initialization of the steering wheel motor failed.

If the error again occurs ever after restarting the power, check the wiring to the steering wheel motor.

If there is something obstructing the movement of the steering wheel, remove it.

#### **Drive board : Centering error**

Initialization of the steering wheel motor failed.

If the error again occurs even after restarting the power, check the wiring to the steering wheel motor.

If there is something obstructing the movement of the steering wheel, remove it.

Also, confirm the the steering wheel volume value changes appropriately.

#### **DRIVE BOARD FAULT DETECTED ENCODER ALARM**

There is an abnormality with the motor encoder data.

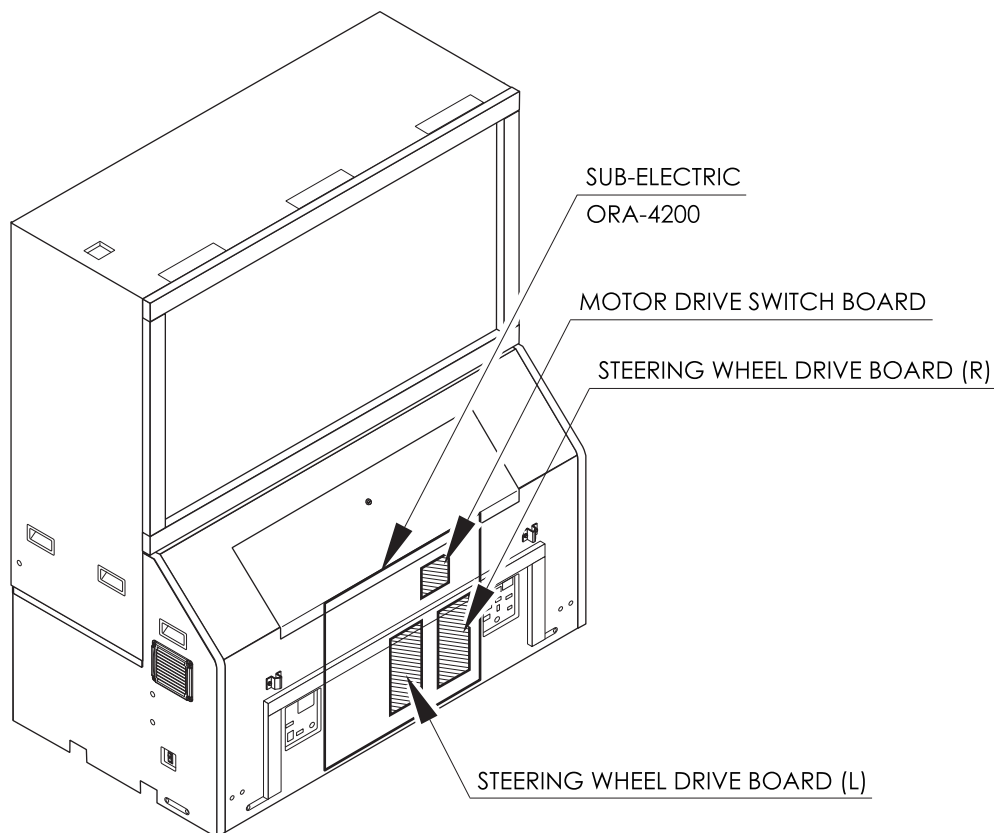
Confirm that there are no abnormalities with the wiring to the motor.

### DRIVE BOARD FAULT DETECTED OVERCURRENT ALARM

Excess current was sent to the motor.  
Confirm that there are no abnormalities with the wiring to the motor.

### DRIVE BOARD FAULT DETECTED OVERHEAT/OVERLOAD ALARM

The motor's thermal indicator was activated.  
Confirm that the motor has proper cooling.



**FIG. 5a Drive Board inside the DLP Base**

#### [Test Mode and Communications Errors]

##### **ERROR OCCURRED CONNECTION TIMEOUT**

The communications check did not succeed within 3 minutes.  
Check the connection of the network cables.  
Confirm that all of the cabinets to connect to network play are displaying the network check screen.  
Confirm that number of TOTAL MACHINE in Game Test Mode matches the number of cabinets to connect to network play.  
Confirm that the LINK\_ID of each cabinet within the same group has a consecutive number, starting from 1.  
Confirm that there are no units with the same LINK\_ID within the same group

##### **ERROR OCCURRED REGION IS NOT COHERENT**

The TOTAL MACHINE setting in Game Test Mode is wrong.  
Confirm that the number of connected cabinets matches the number of TOTAL MACHINE.

##### **ERROR OCCURRED LINK ID ERROR**

An incorrect LINK\_ID was specified.  
Using Game Test Mode, confirm that the LINK\_ID is not higher than the number specified by TOTAL MACHINE.

##### **ERROR OCCURRED VERSION ID IS NOT COHERENT**

The game software versions of connected cabinets do not match.  
Confirm that the software version installed on each connected cabinet is the same.

**ERROR OCCURRED GAME ID IS NOT COHERENT**

The Game IDs of the connected cabinets do not match.  
Confirm that the connected cabinets are OUTRUN2 SP SDX.

**ERROR OCCURRED REGION CODE IS NOT COHERENT**

The country settings of the connected cabinets do not match.  
Confirm that the connected cabinets use the same country specifications.

**ERROR OCCURRED PACKET SIZE ERROR**

An incorrect packet size was specified.  
This is not a normal occurrence. If the problem occurs even after the power is restarted, replace the LINDBERGH.  
Alternatively, contact the point of purchase.

**ERROR OCCURRED OVER %d NODES**

An incorrect TOTAL MACHINE value was specified.  
This is not a normal occurrence. If the problem occurs even after the power is restarted, replace the LINDBERGH.  
Alternatively, contact the point of purchase.

**[Actuator Errors]****L SERVO AMP ERROR**

The left servo amplifier has been stopped because of an overloading error.  
Temporarily cut the power, wait about 30 seconds, and turn the power on again.  
If the error occurs again even after restarting the power, remove the cause of the overload. The servo amplifier may also require replacement.

**R SERVO AMP ERROR**

The right servo amplifier has been stopped because of an overloading error.  
Temporarily cut the power, wait about 30 seconds, and turn the power on again.  
If the error occurs again even after restarting the power, remove the cause of the overload. The servo amplifier may also require replacement.

**ACTUATOR LIMIT SW ERROR**

The limit switch has broken down, or the limit switch's wiring has been disconnected.  
Confirm that there are no problems with the wiring to the limit switch.  
If there are no problems with the wiring, replace the limit switch.

**ACTUATOR L CW LIMIT OVER**

The left actuator's lower limit switch has not been properly installed or has broken down.  
An error will occur when the limit switch was not turned ON.  
Adjust or replace the limit switch.

**ACTUATOR R CW LIMIT OVER**

The right actuator's lower limit switch has not been properly installed or has broken down.  
An error will occur when the limit switch was not turned ON.  
Adjust or replace the limit switch.

**ACTUATOR L CCW LIMIT OVER**

The left actuator's upper limit switch has not been properly installed or has broken down.  
An error will occur when the limit switch was not turned ON.  
Adjust or replace the limit switch.

**ACTUATOR R CCW LIMIT OVER**

The right actuator's upper limit switch has not been properly installed or has broken down.  
An error will occur when the limit switch was not turned ON.  
Adjust or replace the limit switch.



### **ACTUATOR LR CW LIMIT OVER**

The left and right sides' actuators' lower limit switches have not been properly installed or have broken down. An error will occur when the limit switches are not turned ON. Adjust or replace the limit switches.

### **ACTUATOR LR CCW LIMIT OVER**

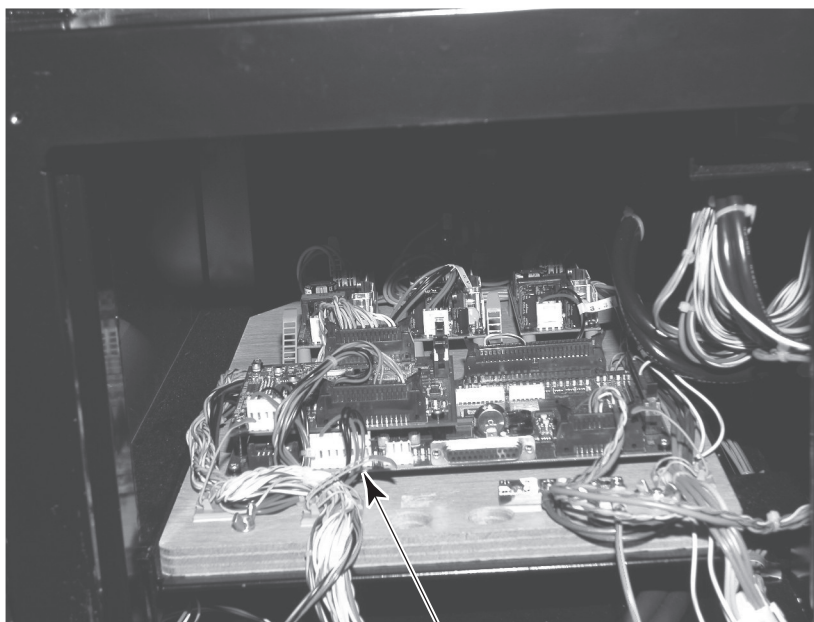
The left and right sides' actuators' upper limit switches have not been properly installed or have broken down. An error will occur when the limit switches are not turned ON. Adjust or replace the limit switches.

### **ACTUATOR TIME OUT ERROR**

Ride initialization did not properly complete or did not occur.

Check the wiring connections from the LINDBERGH to the actuator control board, and from the actuator control board to the servo amplifier.

Confirm that there is power to the actuator control board and to the servo amplifier.



**FIG. 5b Actuator Control Board**

ACTUATOR CONTROL BOARD

The actuator control board is found when the motor driver door at the right side of the cockpit is removed.