

Pachislo Owner's Manual

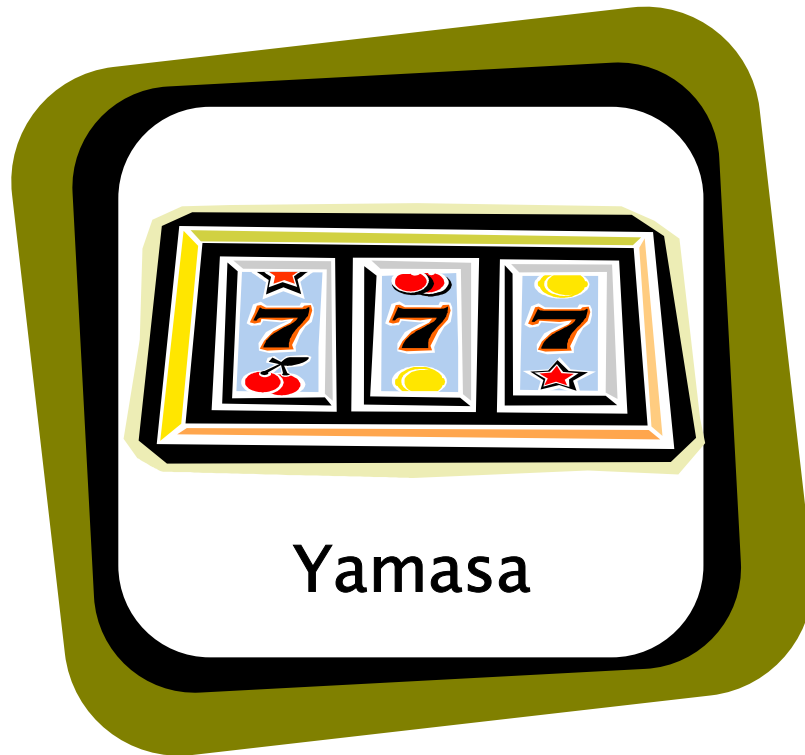

This manual is printed in black and white and includes only the basic information. To obtain a full-colored copy of this manual, please visit our www.stealthhomeamusement.com website and download from our manuals section.

Stealth Home Amusement

Version 1

REVIEW THIS MANUAL BEFORE OPENING PACHISLO

Index

Important Safeguards.....	3
Things in the package	3
Getting Started	3
Outside Description	4
Changing Payout Rates/Full Reset Procedure	4
Basic Description.....	4
Basic Description.....	5
Power box	7
Odds changing button and Odds level credit counter.....	8
Volume controller	9
Additional Information.....	10
Refilling the Hopper	10
Replacing Light Bulbs	10
Reset.....	10
Approximate Payout Odds Rate	10
Error Messages	11
Whoops! I locked my keys in the machine	12
FAQ	13
Parts and Accessories.....	14
Contact Information	14

Important Safeguards

To prevent the pachislo from falling forward when you open the front panel, we recommend attaching it with nails or screws to both a stable base and back wall.

When using an electrical product basic safety precautions should always be followed, including the following:

Warning: to reduce the risk of fire and electric shock:

- close supervision is necessary when any product is used by or near children.
- do not open the operating console or uncover the computer motherboards.
- do not use the pachislo near any other electric devices, water, or heat sources.
- do not attempt to operate the pachislo if it is damaged.

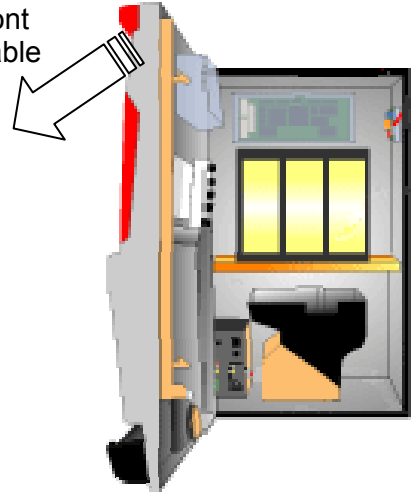

Things in the package

Unpack the pachislo from the carton and confirm the following items are included:

1. A pachislo machine
2. Tokens
3. Door and reset keys
4. Extra light bulbs (If required, many new machines are LED only)
5. Coil key chain
6. Owner's manual



Getting Started

1. Open the front door with a door key by turning the key to the right. Take out the power cable through the hole in the back and plug it in a wall socket.
2. Push the hopper all the way to the back. Put half a bag of tokens into the hopper.
3. Turn the power switch on. Close the front door. Insert tokens into the Token Slot. Make sure the Credit Counter starts counting from the fourth token you put in. Note: Many of the newer machines require 3 tokens to be inserted for game play.
4. The machine is ready to play. Press the reel spin knob. The reels will start spinning.
5. Press the skill stop buttons to stop the reels.

Outside Description

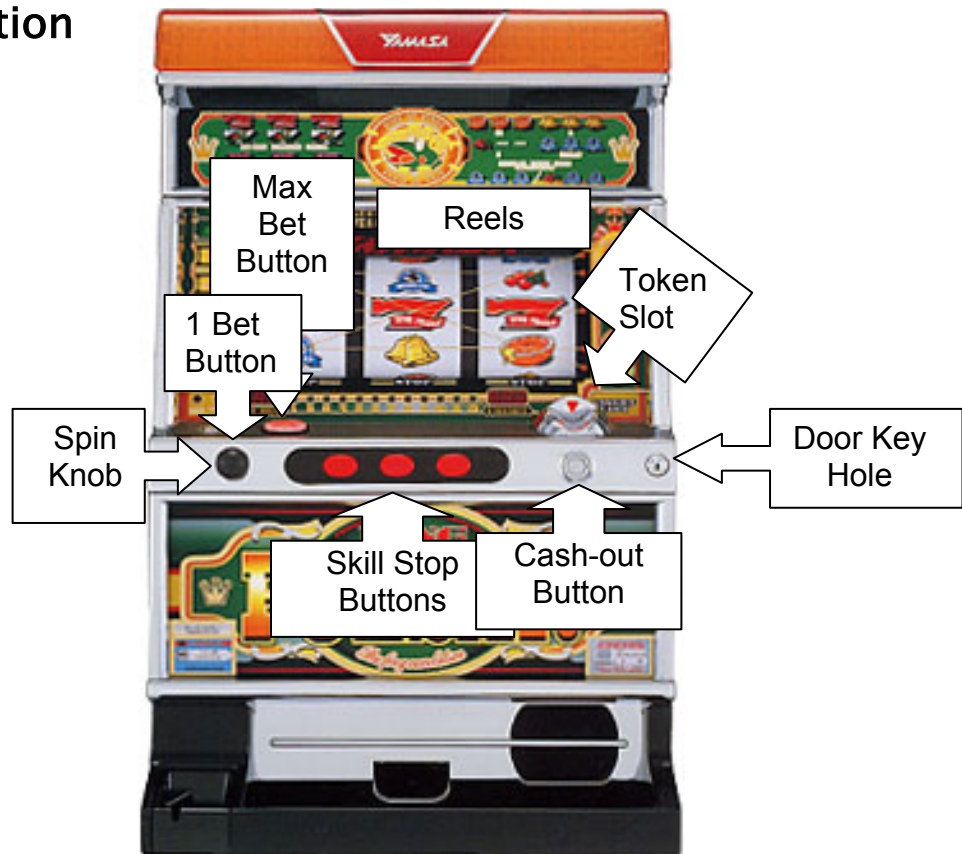

Changing Payout Rates/Full Reset Procedure

Game odds are adjustable to 6 different levels and the odds will vary slightly depending on the machine. Your Pachislo machine is set at Level 6 which is programmed at the highest payout rate (the easiest level). If you want to change your odds, follow the steps below.

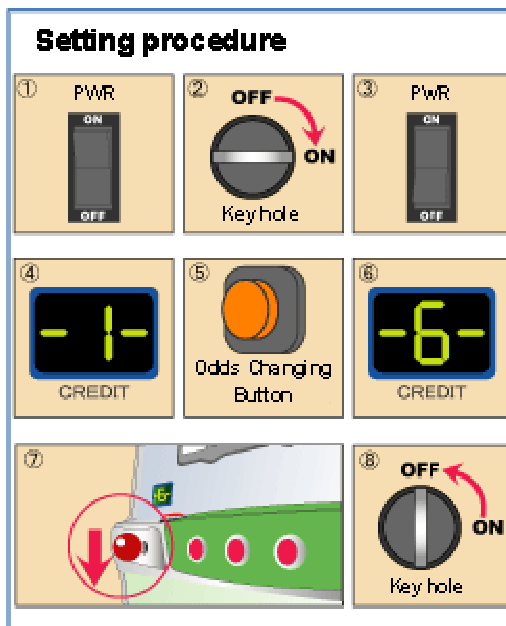

1. Turn the power switch OFF.
2. Put the setting key into the key hole on the power supply.
3. Turn the setting key to the right to the "ON" position.
4. Turn the power switch ON.
5. Make sure the credit counter inside of the front door indicates <1>--<6> *
6. Push the odds rate changing button on the power box OR next to the credit counter inside of the door.
7. Set the payout level.
8. Pull down the spin knob.
9. Turn the key back to the "OFF" (left) position.

* The above picture shows an example of how to change the odd's level from 1 to 6.

Basic Description

Size & Weight

The machines are approximately 32" high, 18" wide, and 13" deep. The dimensions may vary by an inch or so, it depends on which company made the model. They weigh anywhere from 70 to 90 lbs, depending on the model.

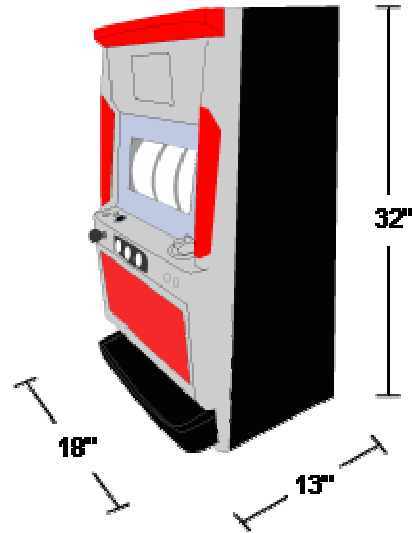

Inside

Inside of the Pachislo machine varies by the model.

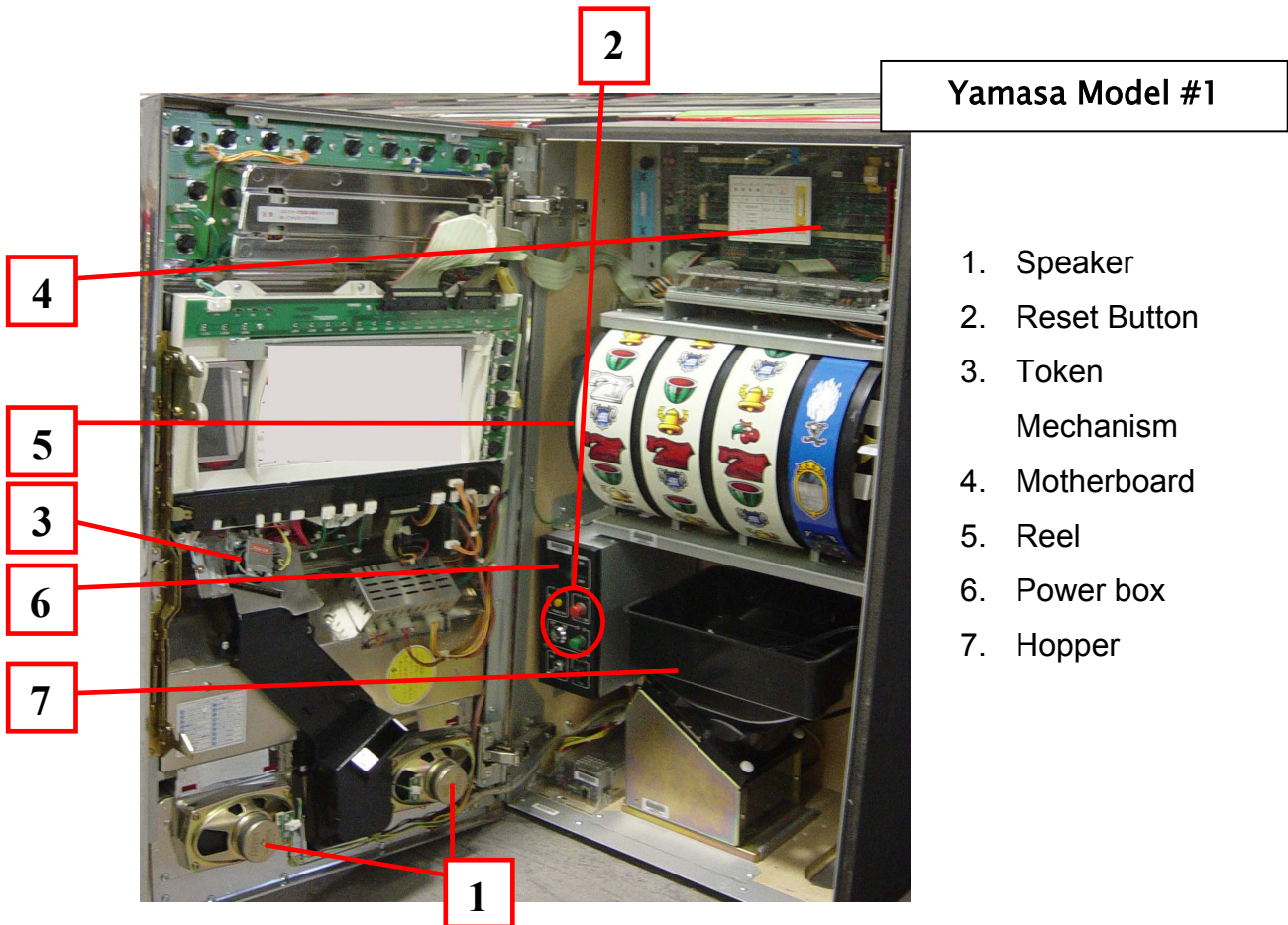

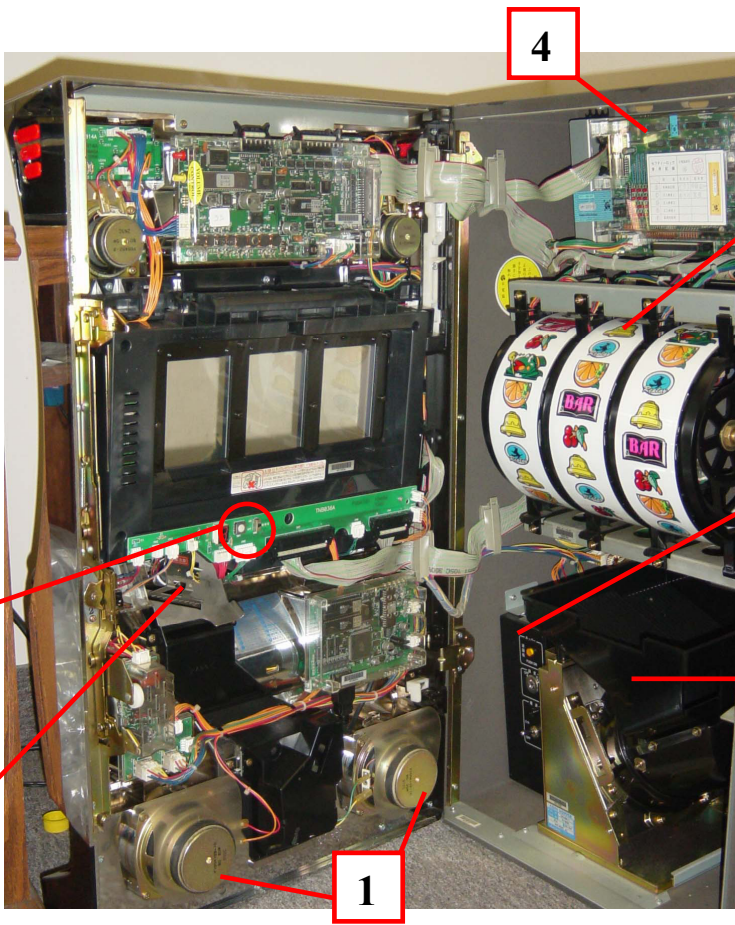

Yamasa Model #2

- 1. Speaker
- 2. Reset Button
- 3. Token Mechanism
- 4. Motherboard
- 5. Reel
- 6. Power box
- 7. Hopper

Yamasa Model #3

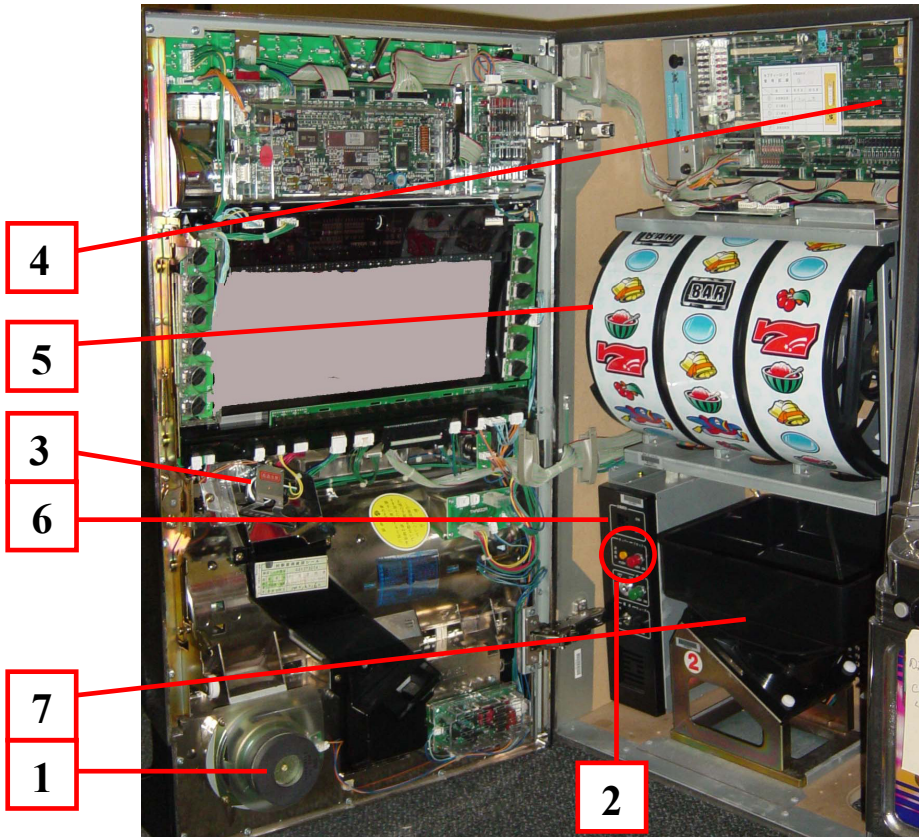

The location of the Power box, Reset button, and Volume controller inside of the pachislo machine varies by the model.

Power box

The Power box will be located in the bottom left corner of your machine. Please find the one that matches with your machine's power box (will vary depending on model).



Basic Description

① Power switch lever ② Black slide switch for auto-reset (always-OFF) ③ Setting key hole

④ Volume Controller ⑤ Reset button (Red button) **R** ⑥ Odds changing button (Green button) **G**

⑦ Hopper reverse button (Yellow button) **Y** ⑧ Fuse holder

Odds changing button and Odds level credit counter

If there isn't an Odds changing button on the Power box in your machine, the Odds changing button will be a small white button next to the Odds level credit counter.

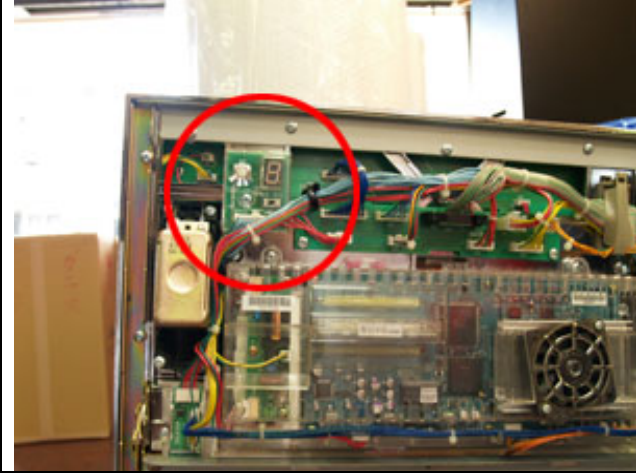

It may be located at the top left corner inside the machine's front door.

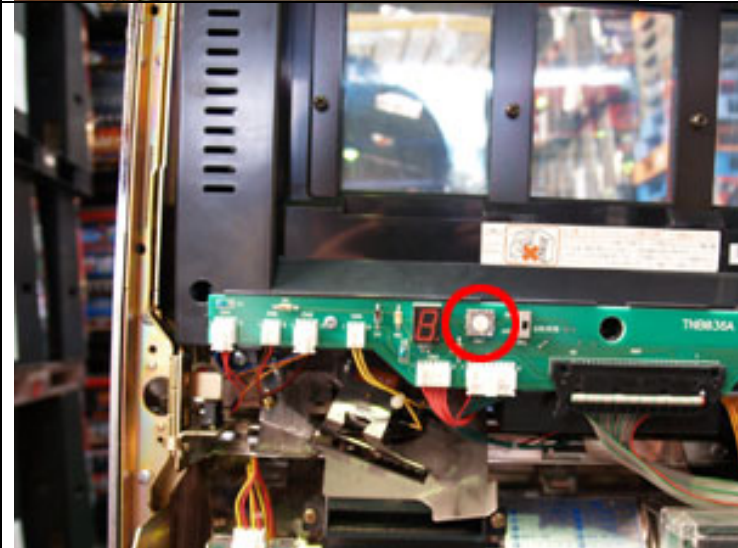

Or it may be located at the bottom of the reel window, inside the machine's front door.

Volume controller

If there isn't volume control on the Power box in your machine, the volume control will be in one of the following locations.

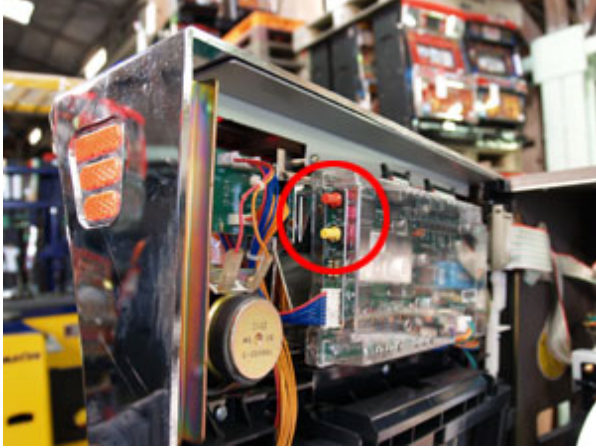

The volume controller is on the top left corner inside the machine's front door. Or the volume controller is on the left side, above the reels in the machine.

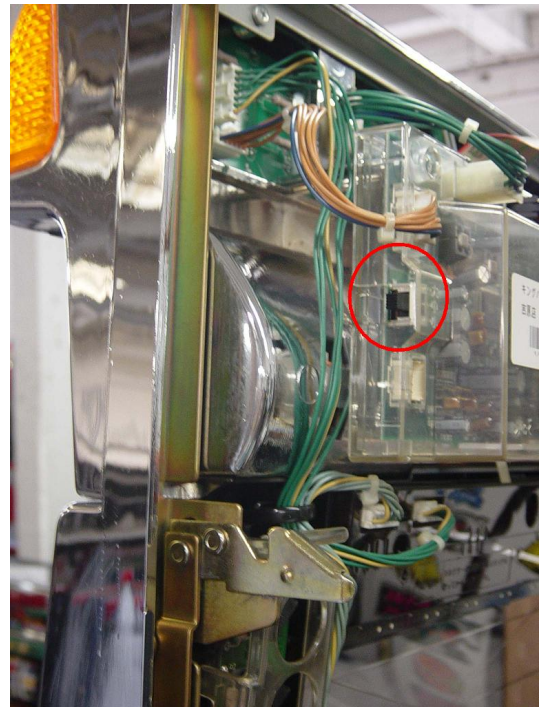
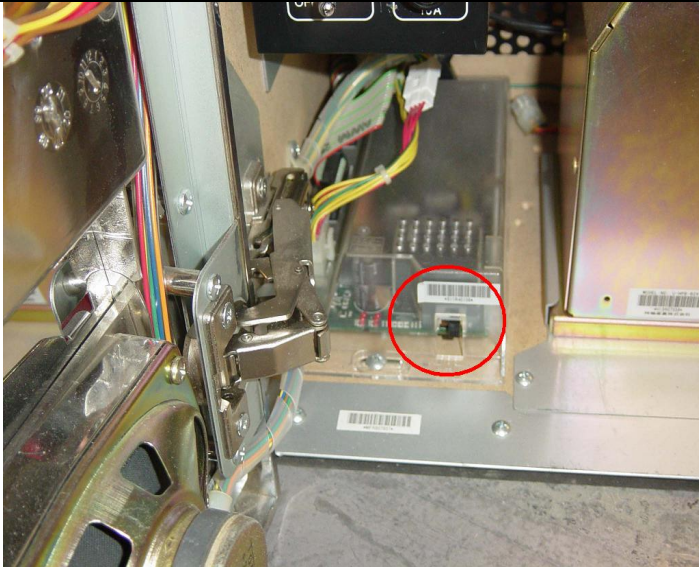

Some machines have a slide volume controller on the bottom left corner inside of machine or on the top left corner inside the machine's front door.

Additional Information

Refilling the Hopper

1. Open the front cover.
2. Put tokens in the hopper.
3. Push the reset button. (Be ready for the tokens to come out!)
4. Close the front cover.

Replacing Light Bulbs

1. Turn off the power switch.
2. Twist the plastic base off the board.
3. Pull the light bulb off the plastic base .
4. Insert a new bulb into the base.
5. Put the plastic base back on the board.



Reset

During the course of play, you may be required to reset the machine. For minor resets such as coin acceptor / hopper malfunctions or a stop after the completion of a bonus game, insert the door key into the door key hole and turn to the **LEFT**. It will reset the game or clear the error code, but not open the door. For major resets such as RAM crash, power surge / outage, or big bonus game interruption, push the reset button inside of the machine or follow the Changing Payout Rates/Full Reset Procedure process.

Approximate Payout Odds Rate

Rates for 1000 tokens invested

LEVEL	BIG BONUS	REG BONUS	PAYOUT
1	1/298	1/607	93.9 - 98.5%
2	1/298	1/607	93.9 - 98.5%
3	1/282	1/512	98.3 - 102.8%
4	1/269	1/443	102.6 - 106.4%
5	1/256	1/390	106.4 - 110.9%
6	1/241	1/364	111.9 – 116.8 %

Error Messages

When your machine has a problem, it indicates it with an error message. Error codes are the following:

E-0/ (CE/CJ)	A token slot is jammed.	Push the button at the token slot.
E-1/ (HE/ HJ)	A hopper is jammed.	Turn off your machine, remove the hopper and take out all the tokens.
E-2/ (HE/ HJ)	Hopper dysfunction.	Check the hopper.
E-3/ (HE/ HJ)	A hopper is empty.	Refill the hopper.
E-4/ (RR)	RAM error.	Push the reset button.
E-5	Reel error.	Restart the machine and push the reset button.
E-6/ (CO)	Prize error.	Push the reset button.
E-7	Hopper Overload.	Check the hopper.
E-8	Hopper disconnected.	Check the cable.
CE/ CJ/ C2	A token slot is jammed.	Need to be cleared and clean with alcohol. Then, press the reset button.

Whoops! I locked my keys in the machine

Sometimes, we all lock our keys in the machine or for some reason the locks do not turn all the way to the right so the door does not open. Here is a way to enter your machine.

- 1) Tip your machine in its left side.
- 2) In the lower right bottom of the machine, there is a hole.



- 3) Reach in the hole, and with your index finger, you will feel the bottom latch of the door towards the front of the machine.

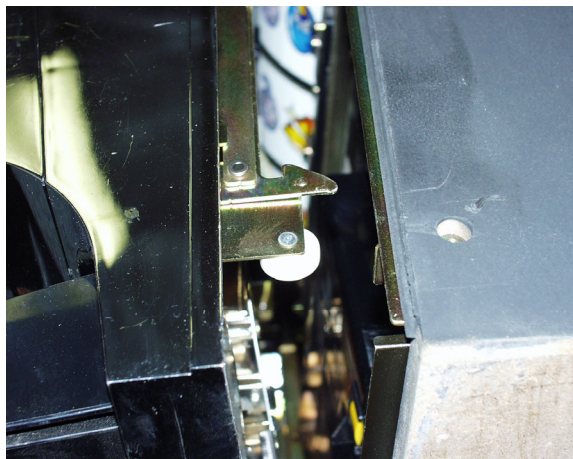

- 4) Pull down on the latch (in some cases you may need to pull up on the latch and the door will open up!)

FAQ

My machine does not power up.	
Answer	Make sure that your machine is plugged into a 120V AC outlet and the power switch is in the ON position. You may have to check fuses as well.
My machine does not accept tokens and "GAME OVER" is indicated.	
Answer	Jackpot condition may have occurred. Reset the machine.
Machine keeps paying in BONUS GAME.	
Answer	This may be normal. Keep playing until the bonus game is complete which is up to 500 tokens OR MORE payout. If you want to end the game immediately, follow the full reset process.
Reels don't spin.	
Answer	Make sure that wire harness to reel bundle is plugged in and secure. Also make sure reels spin freely. Nothing should obstruct the reels from spinning freely. Reset machine by depressing reset switch if necessary.
Reels don't stop after pressing stop buttons.	
Answer	Very common with IGT models after shipping. Check the fuse located on the 3x5 computer card which is on the back or sidewall of inside of your machine. Fuse may have to be replaced. If this is not the problem, please check the ribbon cable connections. You may need to disconnect each cable starting at the reels and reconnect them so the connections "snap" in place.
Machine doesn't switch from "CREDIT" play to "REGULAR" play mode.	
Answer	On most machines, there is a credit/cancel button on the left front of the machine. Press the button for up to 10 seconds as there is a delay on the circuit. Note: All plays go directly into the credit meter on some Yamasa brand machines.
Music is too loud or too soft.	
Answer	Adjust volume control. This switch is located on the inside of the door near the speakers. (Please check Inside part of Basic Description in this manual.) Volume control kit is also available at our website, www.stealthhomeamusement.com .

Parts and Accessories

TOKENS Pachislo Slot machine tokens for all regular pachislo slots that take .984 size tokens. .984 size is a little larger than a quarter	PACHINKO BALLS Various quantities are available. Please contact us.
VOLUME CONTROL KIT Dial volume control kits for your Pachislo slot machine.	LIGHT BULBS Various sizes are available. Please contact us.
TRANSFORMER This transformer has been designed and manufactured specifically for Stealth Home Amusement. These transformers have a push button thermal circuit breaker built in for safety. These transformers are UL recognized. The primary specification is 120v - 50/60 Hz and the secondary is 24v @ 144 VA.	AUTO STOP CHIPS An auto stop chip makes your pachislo reels stop automatically. Please contact us for more detailed information. Available for limited models.

To order:

Visit us on the Website at
<http://www.stealthhomeamusement.com>

Call us at 1-585-271-3844 (MON-FRI: 10am-6pm Est.)

Contact Information

We provide support for our customers. When you have any problems, please contact us via phone or e-mail.

info@stealthhomeamusement.com

Tel: 1-585-271-3844 (MON-FRI: 10am-6pm Est.)



Stealth Home Amusement

1150 University Ave
Rochester, NY 14607

Phone (585) 271-3844
Fax (585) 256-1529

www.stealthhomeamusement.com

Important: All images and texts in this manual are the sole property of Stealth Home Amusement Inc. You may not use them for commercial use without our written permission. Trademarks and images used on the actual Pachislo machines are owned by their respective companies.