



# *Operator's Manual*



TIME WARNER INTERACTIVE



# Operator's Manual

with Schematics

*Patents are pending on several parts of the Primal Rage game.*

## COPYRIGHT NOTICE

**Copyright © 1994 by Atari Games Corporation. All rights reserved.**

No part of this publication may be reproduced by any mechanical, photographic or electronic process, or in the form of a phonographic recording, nor may it be stored in a retrieval system, transmitted, or otherwise copied for public or private use, without permission from the publisher.

The game play, all graphic designs, this technical manual, its accompanying schematic diagrams, and the display manual are protected by the U.S. Copyright Act of 1976.

This Act provides for substantial penalties for violating federal copyright laws. Courts can impound infringing articles while legal action is pending. If infringers are convicted, courts can order destruction of the infringing articles.

In addition, the Act provides for payment of statutory damages of up to \$50,000 per infringing transaction in certain cases. Infringers may also have to pay costs and attorneys' fees and face an imprisonment of up to five years as well as fines of up to \$250,000 in the case of individuals and up to \$500,000 in the case of corporations.

Atari Games Corporation will aggressively enforce its copyrights against infringers. We will use all legal means to immediately halt any manufacture, distribution, or operation of a copy of video games made by us. Anyone who purchases such copies risks forfeiting such a game.

Published by:

Atari Games Corporation  
675 Sycamore Drive  
Milpitas, California 95035

Printed in the U.S.A. 7/94

Produced by the Atari Games Technical Publications Department.

Design, Writing and Editing:

Andrea Dencker

Cover Illustration: Jason

Leong



## NOTICE RE NON-ATARI<sup>®</sup> PARTS

### WARNING

*Use of non-Atari parts or modifications of any Atari game circuitry may adversely affect the safety of your game, and may cause injury to you and your players.*

You may void the game warranty (printed on the inside back cover of this manual) if you do any of the following:

- Substitute non-Atari parts in the game.
- Modify or alter any circuits in the game by using kits or parts *not* supplied by Atari Games Corporation.

## FCC COMPLIANCE

This equipment generates, uses, and can radiate radio frequency energy, and if not installed and used in accordance with the instruction manual, may cause interference to radio communications. It has been tested and found to comply with the limits for a Class A computing device pursuant to Subpart J of Part 15 of Federal Communications Commission (FCC) Rules, which are designed to provide reasonable protection against such interference when operated in a commercial environment. Operation of this equipment in a residential area or modification to this equipment is likely to cause interference, in which case the user, at his own expense, will be required to take whatever measures may be required to correct the interference. If you suspect interference from an Atari game at your location, check the following:

- All ground wires in the game are properly connected as shown in the game wiring diagram.
- The power cord is properly plugged into a grounded three-wire outlet.
- On games provided with an Electromagnetic Interference (EMI) ground plane, be sure that the game printed-circuit boards (PCBs) are properly installed on the EMI ground plane and that the end board is securely installed with **all** screws in place and tightened.

If you are still unable to solve the interference problem, please contact Customer Service at Atari Games Corporation. See the inside front cover of this manual for service in your area.

## S A F E T Y   S U M M A R Y

*The following safety precautions apply to all game operators and service personnel. Specific warnings and cautions will be found in this manual whenever they apply.*

### WARNING

**Properly Ground the Game.** Players may receive an electrical shock if this game is not properly grounded! To avoid electrical shock, do not plug in the game until it has been inspected and properly grounded. This game should only be plugged into a grounded three-wire outlet. If you have only a two-wire outlet, we recommend you hire a licensed electrician to install a three-wire grounded outlet.

**AC Power Connection.** Before you plug in the game, be sure that the game's power supply can accept the AC line voltage in your location. The line voltage requirements are listed in the first chapter of this manual.

**Disconnect Power During Repairs.** To avoid electrical shock, disconnect the game from the AC power before removing or repairing any part of the game. If you remove or repair the video display, be very careful to avoid electrical shock. High voltages continue to exist even after power is disconnected in the display circuitry and the cathode-ray tubes (CRTs). Do not touch the internal parts of the display with your hands or with metal objects! Always discharge the high voltage from the CRTs before servicing them. Do this after you disconnect them from the power source. First, attach one end of a large, well-insulated, 18-gauge jumper wire to ground. Then momentarily touch the free end of the grounded jumper wire to the CRT anode by sliding the wire under the anode cap. Wait two minutes and do this again.

**Use Only Atari Parts.** To maintain the safety of your Atari game, use only Atari parts when you repair it. Using non-Atari parts or modifying the game circuitry may be dangerous, and could injure you and your players.

**Handle the CRTs With Care.** If you drop a CRT and it breaks, it may implode! Shattered glass from the implosion can fly six feet or more.

**Use the Proper Fuses.** To avoid electrical shock, use replacement fuses which are specified in the parts list for this game. Replacement fuses must match those replaced in fuse type, voltage rating, and current rating. In addition, the fuse cover must be in place during game operation.

### CAUTION

**Properly Attach All Connectors.** Make sure that the connectors on each printed circuit board (PCB) are properly plugged in. The connectors are keyed to fit only one way. If they do not slip on easily, do not force them. If you reverse a connector, it may damage your game and void your warranty.

**Ensure the Proper AC Line Frequency.** Video games manufactured for operation on 60 Hz line power (used in the United States) must not be operated in countries with 50 Hz line power (used in Europe). If a 60 Hz machine operates on 50 Hz line power, the fluorescent line ballast transformer will overheat and cause a potential fire hazard. Check the product identification label on your machine for the line frequency required.

### ABOUT NOTES, CAUTIONS, AND WARNINGS

In Atari publications, notes, cautions and warnings have the following meaning:

**NOTE** — A highlighted piece of information.

**CAUTION** — Equipment and/or parts can be damaged or destroyed if instructions are not followed. You will void the warranty on Atari printed-circuit boards, parts thereon, and video displays if equipment or parts are damaged or destroyed due to failure of following instructions.

**WARNING** — Players and/or technicians can be killed or injured if instructions are not followed.

# CONTENTS

## 1 Set-Up

- How to Use This Manual . . . . . 1-1
- Operating the Game . . . . . 1-2
- Inspecting the Game . . . . . 1-2
- Control and Switch Locations . . . . . 1-2
  - Power On/Off Switch. . . . . 1-2
  - Volume Control . . . . . 1-2
  - Self-Test Switch . . . . . 1-2
  - Coin Counter . . . . . 1-2
  - Video Display Controls . . . . . 1-3
- Setting the Coin and Game Options . . . . . 1-3
- Game Play . . . . . 1-3
  - Introduction . . . . . 1-3
  - Game Play . . . . . 1-3
  - One-Player Game . . . . . 1-3
  - Two-Player Game . . . . . 1-4
  - Hidden Features . . . . . 1-4

## 2 Self-Test

- Introduction. . . . . 2-1
- Entering and Exiting the Self-Test . . . . . 2-2
- Select Test Menu . . . . . 2-2
- Adjust Volume. . . . . 2-2
- Statistics. . . . . 2-3
  - Statistics Screen . . . . . 2-3
  - More Statistics Screen . . . . . 2-3
  - Histogram Screens . . . . . 2-4
- Game Options . . . . . 2-4
- Coin Options . . . . . 2-5
- Controls Test . . . . . 2-5
- Sound Test. . . . . 2-6
- RAM (Memory) Tests . . . . . 2-6
- ROM Test . . . . . 2-6
- Video Tests . . . . . 2-6
  - Playfield Scrolling . . . . . 2-7
  - MOB (Moving Object) Checksums . . . . . 2-7
  - Alphanumerics. . . . . 2-7
- Monitor Tests . . . . . 2-7
  - Color Test . . . . . 2-7
  - Purity Test. . . . . 2-8
  - Convergence Test . . . . . 2-8

## 3 Troubleshooting and Maintenance

- Introduction. . . . . 3-1
- Maintenance Procedures. . . . . 3-2
  - Introduction . . . . . 3-2
  - Cleaning Procedure for Coin Mechanisms . . . . . 3-2
- Troubleshooting Procedures . . . . . 3-2
- Repair Procedures . . . . . 3-2
  - Introduction . . . . . 3-2
  - Speakers . . . . . 3-3
  - Attraction Panel Light Bulb . . . . . 3-3
  - Pot Joysticks . . . . . 3-3
  - System Logic Assemblies . . . . . 3-3
  - Video Display . . . . . 3-6

## 4 Parts Illustrations

Part Ordering Information . . . . . 4-1  
 For figure and page numbers, see the list of illustrations that follows.

## 5 Schematics

See the list of illustrations that follows.

## Warranty

Inside back cover



## ILLUSTRATIONS

Figure 2-1	Select Test Menu Screen.....	2-2
Figure 2-2	Adjust Volume Screen.....	2-2
Figure 2-3	Statistics Screen.....	2-3
Figure 2-4	More Statistics Screen.....	2-3
Figure 2-5	Histograms Screen.....	2-4
Figure 2-6	Game Options Screen.....	2-4
Figure 2-7	Coin Options Screen.....	2-5
Figure 2-8	Controls Test Screen.....	2-5
Figure 2-9	Sound Test Screen.....	2-6
Figure 2-10	Memory Tests Screen.....	2-6
Figure 2-11	Video Tests Screen.....	2-7
Figure 2-12	Playfield Scrolling Screen.....	2-7
Figure 2-13	MOB Checksums Screen.....	2-7
Figure 2-14	Alphanumerics Test Screen.....	2-7
Figure 2-15	Color Test Screen.....	2-8
Figure 2-16	Purity Test Screen.....	2-8
Figure 2-17	Convergence Test Screen.....	2-8
Figure 4-1	Cabinet Overview.....	4-2
Figure 4-2	Power Supply Assembly.....	4-3
Figure 4-3	Over/Under Coin Door Assembly.....	4-4
Figure 4-4	Board Stack Assembly.....	4-6
Figure 4-5	Primal Rage Game (GT) PCB Assembly.....	4-8
Figure 4-6	GT24M8 PCB Assembly.....	4-15
Figure 4-7	JAMMA Filter PCB Assembly.....	4-17

Figure 5-1	Primal Rage Game (GT) PCB Assembly Schematic Diagram.....	5-2
Figure 5-2	Coin Door Wiring Diagram.....	5-7
Figure 5-3	GT24M8 PCB Assembly Schematic Diagram.....	5-8
Figure 5-4	JAMMA Filter PCB Assembly Schematic Diagram.....	5-14
Figure 5-5	Primal Rage Game Wiring Diagram...	5-16
Figure 5-6	CH31_2 (CAGE™ Audio) Board Block Diagram.....	5-18

## TABLES

Table 1-1	Game Specifications.....	1-2
Table 2-1	Summary of All Self-Test Screens.....	2-2
Table 2-2	Game Option Settings.....	2-4
Table 2-3	Coin Option Settings.....	2-5
Table 3-1	General Troubleshooting.....	3-4
Table 3-2	ROMs and RAMs Troubleshooting.....	3-5
Table 3-3	Voltage Inputs and Test Points.....	3-6



# Set-Up

## How to Use This Manual

**T**HIS MANUAL IS written for operators and service personnel. It provides information for setting up, playing, testing, and maintaining your Primal Rage™ game.

Primal Rage is a one- or two-player head-to-head fighting game featuring fantasy creatures and state-of-the-art animation.

Chapter 1 of this manual contains set-up and game play information. ♦ Chapter 2 contains a description of the self-test procedures and option settings. The self-test is important in the Primal Rage game. You can troubleshoot the printed-circuit boards (PCBs), main circuits, and controls using the screens in the

self-test. You should regularly test the boards and controls with the self-test to keep your game in peak condition and at top earnings. ♦ Chapter 3 contains several troubleshooting tables, plus maintenance and repair procedures for the game components. If you have problems with your game, use this chapter to troubleshoot and repair it. Be sure to perform the preventive maintenance tasks to keep your game in good condition. ♦ Chapter 4 contains the illustrations and PCB parts lists. ♦ Chapter 5 contains the schematics for all the PCBs and all the wiring diagrams.

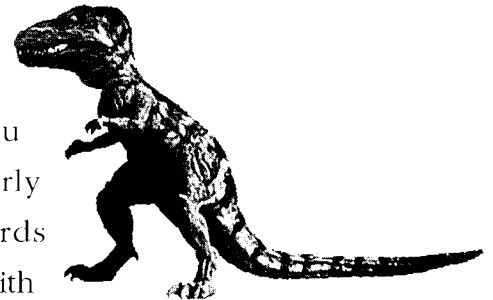

# Operating the Game

To operate your game for maximum income, you should regularly run the self-test and check the controls with the Control Test and Sound Test in the self-test. By using the self-test regularly, you can find and fix problems immediately. This lets you keep your game in top condition.

## Inspecting the Game

### WARNING

*To avoid electrical shock, do not plug in the cabinet until it has been properly inspected and set up for the line voltage in your area.*

This cabinet should be connected to a grounded three-wire outlet only. If you have only two-wire outlets, we recommend that you hire a licensed electrician to install grounded outlets. Players can receive an electrical shock if the cabinet is not properly grounded.

Make note of the power consumption when you set up this game, so that you do not overload your electrical circuit. See Table 1-1 for the power consumption and the other important specifications of this game.

Inspect your Primal Rage game carefully to ensure that the game is complete and was delivered to you in good condition. Inspect the cabinet and seat as follows:

1. Examine the exterior of the cabinet for dents, chips, or broken parts.
2. Open the lower rear access panels. Unlock and open the coin doors. Inspect the interior of the cabinet as follows:
  - a. Check that all plug-in connectors on the cabinet harnesses are firmly plugged in. Do not force connectors together. The connectors are keyed so they fit only in the proper orientation. A reversed connector can damage a printed-circuit board (PCB). This will void your warranty.
  - b. Ensure that all plug-in integrated circuits on each PCB are firmly plugged into their sockets.
  - c. Inspect the power cord for any cuts or dents in the insulation.
  - d. Inspect the power supply. Make sure that the correct fuses are installed. Check that the harness is plugged in correctly. Check that the green ground wires are connected.

Characteristic	Specification
<b>Input Current</b>	3 Amps at 120 V
<b>Line Fuse Rating</b>	3 Amps at 250 V, slow blow
<b>Line Voltage</b>	102 to 132 VAC
<b>Temperature</b>	5° to 38° C (37° to 100° F)
<b>Humidity</b>	Not to exceed 95% relative
<b>Width</b>	25.25 inches (64 cm)
<b>Depth</b>	33 inches (84 cm)
<b>Height</b>	71.75 inches (182 cm)
<b>Weight</b>	325 lbs. (148 kg)

**Table 1-1 Game Specifications**

- e. Inspect other sub-assemblies, such as the video displays, controls, printed-circuit boards, and speakers. Make sure that they are mounted securely and that the ground wires are connected.

## Control and Switch Locations

All of the controls are located on the back of the cabinet or behind the coin doors. The following describes the locations in more detail:

### Power On/Off Switch

The power on/off switch is located near the top of the cabinet lower rear panel.

### Volume Control

There is no volume adjustment knob on any PCB in this game. Instead, volume is adjusted in the self-test software. The attract-mode and game-play volumes can be adjusted separately. Refer to Chapter 2 of this manual for more information.

### Self-Test Switch

To perform the self test, open the upper coin door and activate the self-test switch mounted on a bracket located on the inside left panel of the game cabinet.

### Coin Counter

The coin counter is located below the coin box, inside the coin door.



## Video Display Controls

This game provides access to six of the most important video display controls — vertical and horizontal position, vertical hold, vertical size, black level, and contrast. To gain access to the video display controls, remove the rear panel. The control knobs are mounted on the inside of one of the side panels.

## Setting the Coin and Game Options

The Primal Rage coin and game options are set in the self-test. Refer to Chapter 2 for the recommended settings and the procedure for setting the options.

## Game Play

This section describes the features and play of the Primal Rage game.

### Introduction

Primal Rage is a head-to-head fighting game featuring state-of-the-art stop-motion animated characters. Players choose from seven different giant fantasy creatures in an attempt to dominate the new “Urth,” using fighting moves, powerful “secret” moves, masterful combo hits and graphic finishing sequences to eliminate their opponent.

Primal Rage utilizes a proprietary new stop-motion animation technique that provides realistic and life-like character motion. In addition to state-of-the-art graphics, Primal Rage features the new CAGE “Total Immersion Audio” system, providing great stereo sound that punctuates high-impact game play.

Due to their great size and special powers, each of the seven available characters in Primal Rage is worshipped as a “god” by the surviving humans of Urth. As players go through the game, they amass additional followers with every victory. Followers can also be eaten to replenish strength, if needed, but this is really a matter of personal taste.



**Total Immersion Audio**

Primal Rage features a four-button control that allows “power” hits to be mapped onto both the top and bottom button pairs.



To execute special moves, players must press and hold button combinations while moving the joystick at the same time, in a method that differs from standard fighting game controls. This allows for a diversity of regular hits while at the same time providing a new way of executing special moves. Because of this feature, Primal Rage controls allow for very fluid combination potential. Advanced players will be motivated to learn all of the moves to develop the best combinations, providing the driving force for high-level competitive action.

### Game Play

The game offers two basic types of play:

- One-player game. The player must defeat all seven opposing characters to get to the Bonus Round and Final Battle.
- Two-player game. Players battle each other for trophies, human followers, and World Domination. The winner is the player who captures the most “globes” and amasses the most followers.

### One-Player Game

The player must defeat all seven opposing characters, one at a time, in order to get to the Bonus Round and Final Battle. Each player and opponent character has a “health bar” at the top of the screen that is reduced whenever a damaging hit is made. If a player’s health bar is reduced, human followers can be eaten for bonus health. Each opponent defeated will result in a new territory being awarded.

### Finishing Moves

When an opponent character has lost all its health and is standing there dizzy, the character is in its “death throes” and is about to die. The “finishing move” is a special button combination (different with each character) that can be used to “finish off” an opponent while it is in its death throes. Using a finishing move demonstrates technique and generates excitement, but, most importantly, affects the status of opponent characters when they return during the Final Battle. Players will be motivated to master all of the finishing moves in order to play a perfect game.

### **Bonus Round and Final Battle**

After defeating all seven opponents, the player is awarded a Bonus Round, during which points and bonus health can be collected by snacking on human followers. After the Bonus Round, the player moves to the Final Battle, during which all of the player's foes must be quickly vanquished once again, only this time with a twist: the player has only one health bar plus bonus health, and each opponent character will return either as a normal character or as a ghost-like character.

Any character that the player did not eliminate using a finishing move during the regular rounds will come back as a normally healthy character. Characters on which a player successfully executed finishing moves will return as ghosts that suffer more damage per hit inflicted.

Any player who has won the Final Battle is rewarded with the story line for that character and a special graphic picture depicting that character's life after they have captured Urth. Players who lose all of their health during the Final Battle have the opportunity to continue the game by adding more coins.

### **Challenge Game**

During a 1-player game, another player can challenge the current player by inserting coins in the unused side of the game. The original player now competes against the new challenger.

### **Two-Player Game**

Players battle each other in a match decided by winning two out of three rounds. A trophy and human followers are awarded to the player who wins each round, and a new territory on the globe is awarded to the winner of the match.

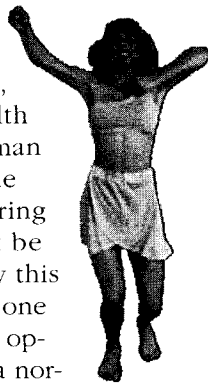

### **Human Followers**

Human followers are awarded for various accomplishments in the game. The number of followers awarded depends upon how well a player fights, including attack combinations, damage to the opponent, use of finishing moves, and fatalities.

### **Sudden Death**

If the two players are tied at the end of the third round (same number of trophies and both players still alive), then a Sudden Death round is started. At the beginning of Sudden Death, the timer is reset to 20 and players receive full health bars. During play, each player's health bar will be reduced by time and hits. If Sudden Death ends without a victor, both players will die and the game will end in a tie.

### **World Domination**

In order to achieve World Domination, a player must win all seven territories on the globe. When this is achieved, the player will be awarded a globe and more human followers. There is no limit to the number of globes awarded in a 2-player game. The winner is the player who captures the most globes and amasses the most human followers.

### **Hidden Features**

Many hidden features are included in Primal Rage. Some of these features are activated by different joystick and button combinations. Some are skill-specific and some require cooperation between players. Many hidden features depend upon which character is being played, which background is in view, or which combination of moves is used.

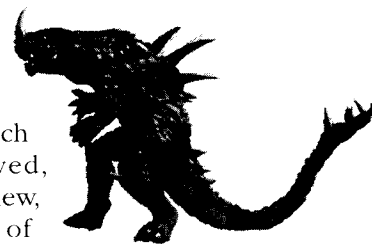

# Self-Test

## Introduction

**U**SE THE PRIMAL RAGE™ self-test to check the condition of the game circuitry and controls. You will see the self-test information on the video display and hear the sound test information through the speakers. You do not need any additional equipment to perform the self-test. Perform the self-test when you first set up the game, each time you collect the money, or when you suspect game problems. This chapter shows the screens in the self-test and explains each of the tests. The screens and explanations are arranged in the order they appear in the self-test. Table 2-1 lists all the self-test screens.

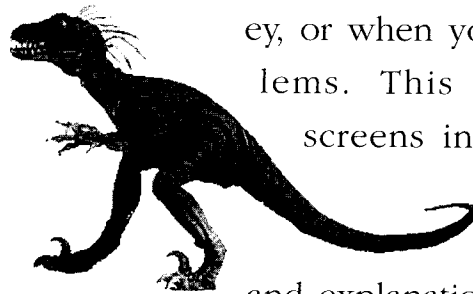

# Entering and Exiting the Self-Test

The game's self-test switch is located behind the coin door. Turning it on causes the screen to enter the self-test mode. Doing so displays the Select Test menu; see Figure 2-1. Exit the self-test by turning off the self-test switch at any time.

At the bottom of the self-test screen you may find that the MOS or OS versions shown in this manual are different from your game. Any version differences in the software are unimportant.

## Select Test Menu

Choose which test or screen you want to see from this menu, shown in Figure 2-1. Move up and down the menu by moving either joystick up or down (or by pressing the left player upper right button). Start the

selected test by pressing the left player upper left button.

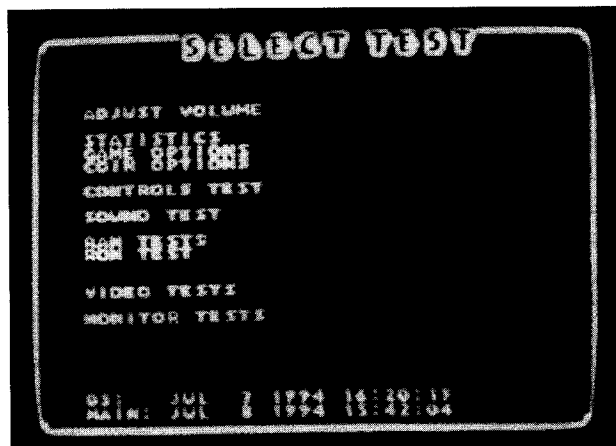

Figure 2-1 Select Test Menu Screen

Select Test Menu
Adjust Volume
Statistics
Statistics
More Statistics
Histograms
Game Options
Coin Options
Controls Test
Sound Test
RAM (Memory) Tests
Video RAM
Video RAM (quick)
Color RAM
Working RAM
Working RAM (quick)
All RAM
ROM Test
Video Tests
Playfield Scrolling
MOB (Moving Objects) Checksums
Alphanumerics
Monitor Tests
Color Test
Purity Test
Convergence Test

Table 2-1 Summary of All Self-Test Screens

## Adjust Volume

Adjust the volume of the game using this screen, shown in Figure 2-2. Follow the instructions at the bottom of the screen to restore the old volume level or to save the new volume and return to the select test menu.

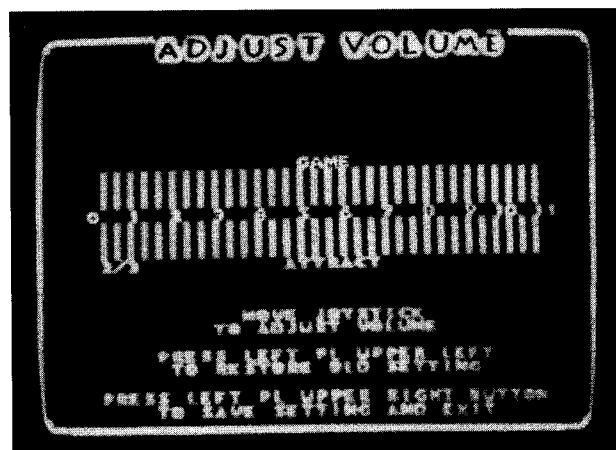

Figure 2-2 Adjust Volume Screen

The software continuously plays music to allow you to adjust both the game and attract-mode volume levels. The word *GAME* or *ATTRACT* flashes to show which of the two volumes levels you are adjusting. Move either joystick up or down to select either one. The attract-mode volume level has four steps: mute, 1/3, 2/3 or full volume level (these are fractions of the game volume level).

# Statistics

Use the information shown in the statistics and histogram (bar graph) screens to keep track of your game use and maximize your profits.

The game statistics are collected from the last time the statistics were cleared. Follow the instructions at the bottom of the screen to clear the statistics or to advance to the next statistics or histogram screen.

## Statistics Screen

The Statistics screen (see Figure 2-3) lists the following information:

- Left Coins shows the number of coins counted in the left coin mechanism.
- Right Coins shows the number of coins counted in the right coin mechanism.
- Aux Coins shows the number of coins manually added by the operator. (not inserted into any mechanism).
- Idle Minutes shows the number of minutes that the game was idle and not being played.
- 1-Player Minutes/2-Player Minutes shows the number of minutes that the game was played by one or two players.
- New Game Minutes shows the number of minutes played after starting a new game.
- Continued Game Minutes shows the number of minutes played after continuing a game.
- EEPROM Error Count shows the number of errors counted in the erasable memory. If you have an error count, the statistics may be wrong. If you consistently have errors counted for several weeks, replace the EEPROM at 22H on the Primal Rage game PCB.

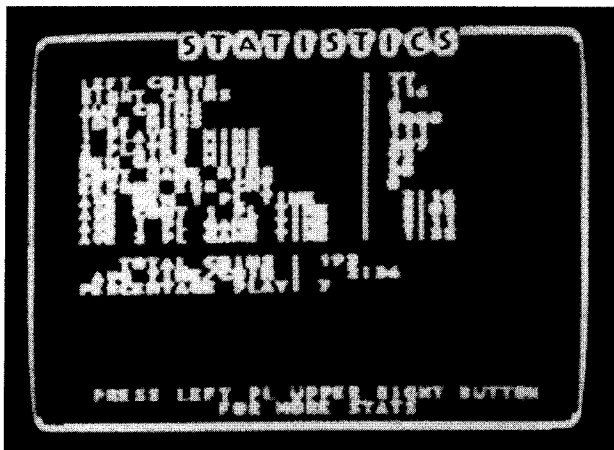

**Figure 2-3 Statistics Screen**

- Average New/Continued 1 Player Time shows an average of the number of minutes played by one player in a new or continued game.
- Average 1 Player/2 Player Game Time shows an average of the number of minutes played in one game by one or two players.
- Total Coins shows the number of coins counted in both left and right coin mechanisms.
- Average Time per Coin shows an average of the number of minutes played for every coin counted.
- Percentage Play shows the ratio of game playing time to total time the game has been turned on.

## More Statistics Screen

The More Statistics screen (see Figure 2-4) lists the following information:

- 1 Player/2 Player Games shows the number of games played by 1 or 2 players.
- 1 Player/2 Player Continues shows the number of games continued by 1 or 2 players.
- 1 Player Finishes shows the number of games finished in 1-player game mode.
- Challenge Games shows the number of 1-player games interrupted by a 2nd-player challenge.
- Sudden Deaths shows the number of tie games decided by sudden death.
- Final Battles shows the number of times a single player achieved a Final Battle.
- Final Continues shows the number of credits used during a Final Battle.

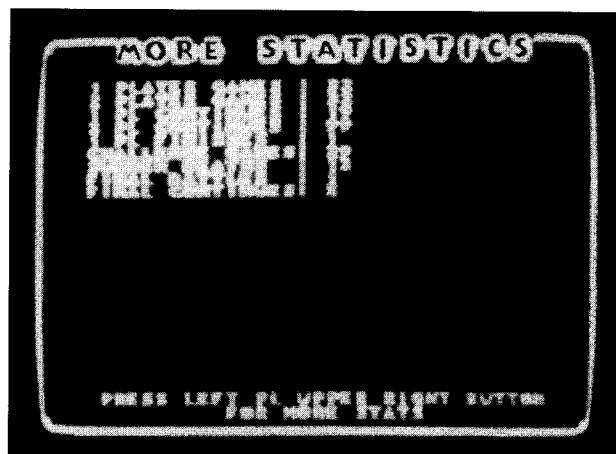

**Figure 2-4 More Statistics Screen**

## Histogram Screens

The Histograms screen is a menu that lets you display one of three screens (see Figure 2-5). These show various horizontal bar graphs for round time, match time, and selections per character.

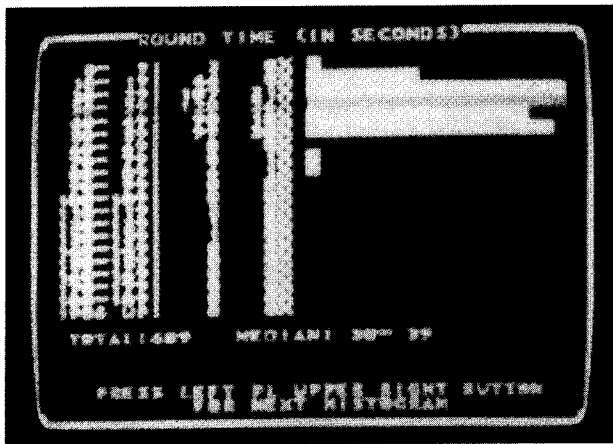

Figure 2-5 Histograms Screen

## Game Options

Check and select the game options on this screen, shown in Figure 2-6. The screen shows the factory default settings in green.

To move through the options, to change or save the settings, or to return to the select test menu, follow the

instructions shown at the bottom of the screen. The game options, with defaults, are shown and explained in Table 2-2.

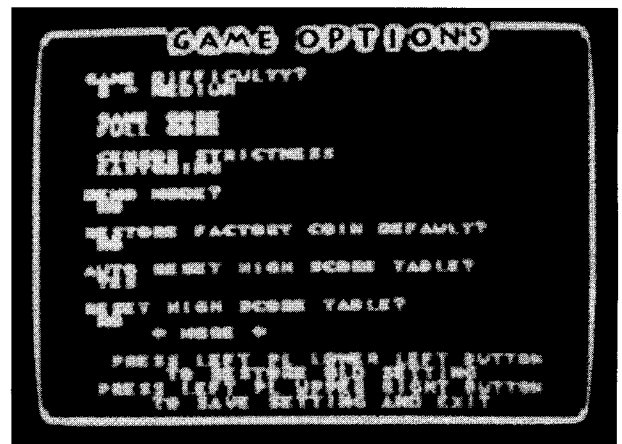

Figure 2-6 Game Options Screen

## Coin Options

Check and select the coin options on this screen, shown in Figure 2-7. The screen shows the factory default settings in green.

To move through the options, to change or save the settings, or to return to the select test menu, follow the instructions shown at the bottom of the screen. The coin option settings, with defaults, are shown and explained in Table 2-3.

Game Option	Available Settings		Explanation
<b>Game Difficulty</b>	Easiest ... Most Difficult	Medium ✓	Provides a choice of sixteen levels of game difficulty.
<b>Game Gore</b>	No Gore	Full Gore ✓	Provides a choice of two levels of gory effects. <i>No Gore</i> disables all blood and finishing moves.
<b>Censor Strictness</b>	Easygoing	Strict ✓	<i>Strict</i> setting disallows certain vulgar letter combinations in the high score table and in the top score display.
<b>Demo Mode</b>	Yes	No ✓	In demo mode, characters never die. This setting should be used for demonstrations only.
<b>Restore Factory Coin Default</b>	Yes	No ✓	Returns coin settings to factory default.
<b>Auto Reset High Score Table</b>	Yes ✓	No	Automatically clears the high score table periodically.
<b>Reset High Score Table</b>	Yes	No ✓	Clears the high score table the next time you start a game (one time only).
<b>Restore Factory Default</b>	Yes	No ✓	Returns all game settings to factory default.

✓ *Manufacturer's recommended settings*

Table 2-2 Game Option Settings

Coin Option	Available Settings	Explanation
<b>Free Play</b>	No ✓ Yes	Lets you choose free play to demonstrate the game.
<b>Discount to Continue</b>	No ✓ Yes	When set to Yes, this option reduces by 50% the player's cost to continue a game (always rounded up to the next full coin).
<b>Game Cost</b>	1 coin 1 credit 2 coins 1 credit ✓ 3 coins 1 credit ... 8 coins 1 credit	The number of coins required for one credit.
<b>Bonus for Quantity Buy-in</b>	None ✓ 2 coins give 1 3 coins give 1 3 coins give 2 ... 9 coins give 2 9 coins give 3	Lets you choose from various kinds of bonuses or no bonus.
<b>Right Mech Value</b>	1 coin counts as 1 coin ✓ 1 coin counts as 2 coins ... 1 coin counts as 7 coins 1 coin counts as 8 coins	The number of coins each coin counts as in the right coin mechanism.
<b>Left Mech Value</b>	1 coin counts as 1 coin ✓ 1 coin counts as 2 coins ... 1 coin counts as 7 coins 1 coin counts as 8 coins	The number of coins each coin counts as in the left coin mechanism.

✓ Manufacturer's recommended settings

**Table 2-3 Coin Option Settings**

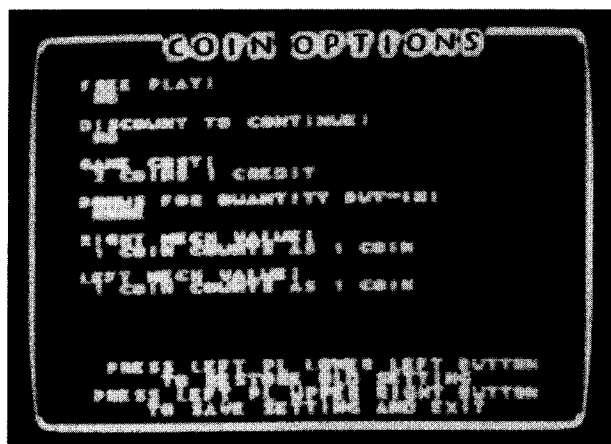

**Figure 2-7 Coin Options Screen**

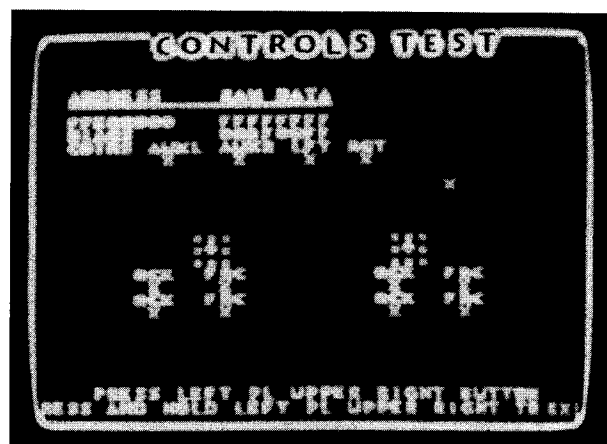

**Figure 2-8 Controls Test Screen**

## Controls Test

The controls test screen is shown in Figure 2-8. This test checks all the pushbutton switches and the joystick potentiometers.

As you use each control, the numbers for the joystick pots increase or decrease, or the red Xs for switches become 0s. If the changes do not appear on the screen, check the controls and their wiring.

To reset the joystick pot limits, to change or save the settings, or to return to the select test menu, follow the instructions shown at the bottom of the screen.

Press and *hold* the left player upper right button to exit from the controls test.

## Sound Test

Use this selection screen, shown in Figure 2-9, to test the sound board.

### NOTE

*The audio boards must be installed and connected in the game to perform this test.*

To check the audio ROMs, run the Audio Checksums test. To determine if all three speakers are working properly, select the Speaker Test.

In the Audio Checksums test, verify that all the checksums are displayed in white. If any of them show red numbers, you have a problem with the circuitry or ROMs. If all ROMs are bad, suspect the circuitry. If a single checksum is bad, check for improper ROM seating.

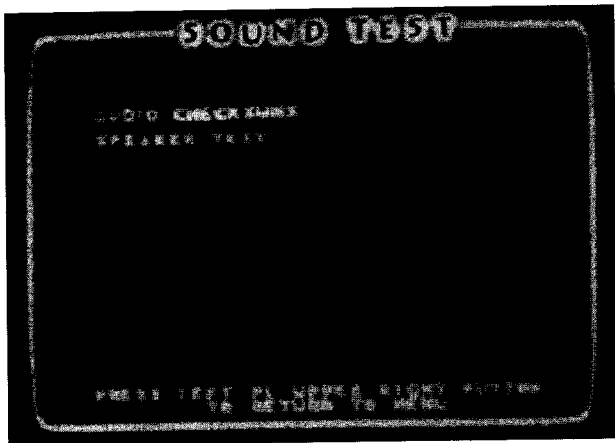

**Figure 2-9 Sound Test Screen**

When you select the Speaker Test, you will hear a sequence of three sounds, with a different sound coming from each speaker: the left speaker will emit a frog sound, the right speaker will emit a woman's scream, and the sub-woofer will emit a booming football sound.

### NOTE

*The football sound coming from the sub-woofer will also be heard to a certain extent from the other two speakers.*

## RAM (Memory) Tests

Use this selection screen, shown in Figure 2-10, to run any of the five RAM tests. These tests check the RAM chips in various ways.

When you turn on the power, the game automatically runs through the random-access memory (RAM) tests. Refer to Chapter 3 of this manual for more details.

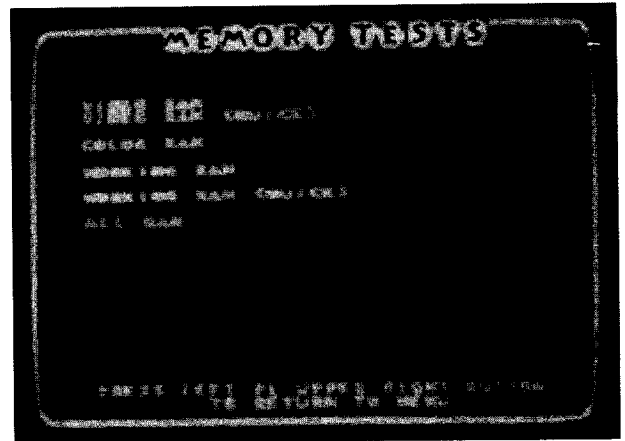

**Figure 2-10 Memory Tests Screen**

## ROM Test

This screen displays any ROM errors by showing a non-zero number after a particular item. A properly working board should cause your screen to display only 0s in the right column.

If a ROM fails, a message may be displayed. However, depending on how bad the ROM error is, you may not be able to enter the self-test.

If you have a ROM error, check the four ROMs labeled PGM\_LL, PGM\_LM, PGM\_UM, and PGM\_UU at 24L through 29L on the Primal Rage game PCB. Check these locations for bent pins or incorrectly inserted chips. Also see Table 3-2 for information about the locations of the ROMs and their functions.

## Video Tests

Use this selection screen, shown in Figure 2-11, to determine the condition of the video circuitry on the game PCB.



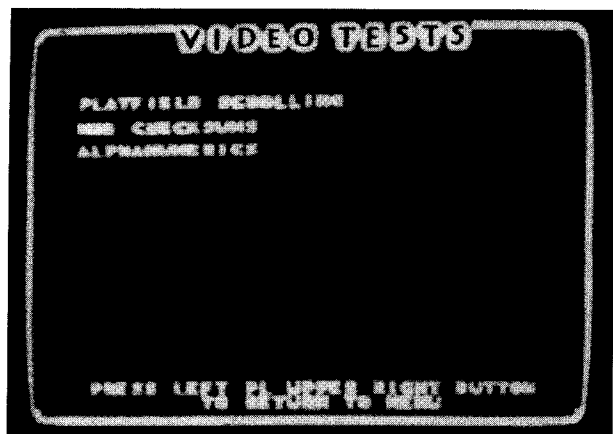

Figure 2-11 Video Tests Screen

### Playfield Scrolling

The playfield scrolling test is shown in Figure 2-12. To scroll the playfield continuously in a horizontal or vertical direction, move the joystick in the corresponding direction. Make sure that the playfield screen is clean and scrolls smoothly across the screen.

If the screen image does not move, or appears different from Figure 2-13, you have a problem in the playfield circuitry at locations 25N–28N on the Primal Rage game PCB. To return to the select test menu, follow the instructions shown at the bottom of the screen.



Figure 2-12 Playfield Scrolling Screen

### MOB (Moving Objects) Checksums

The first MOB test screen examines the checksums of the MOB ROMs. If the checksums match, you should see the white numbers displayed as shown in Figure 2-13. The twelve designations listed in the left column on the screen (MOH0/MOL0 through 1.3) are the labels on the chips, located on the Primal Rage PCB and the GT24M8 piggyback board. If the checksums do not match, either you have a defective EPROM/ROM or a chip may be installed incorrectly.

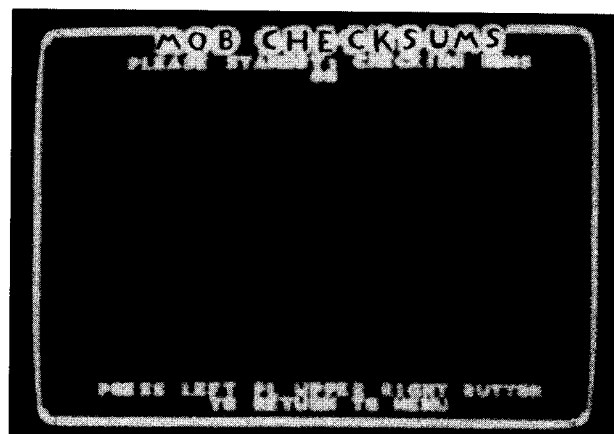

Figure 2-13 MOB Checksums Screen

### Alphanumeric

The alphanumeric test is shown in Figure 2-14. To page (scroll) the screen up/down, move the joystick accordingly. If the screen image does not move, or appears different from this figure, you have a problem in the alphanumeric circuitry at location 22P/R on the Primal Rage game PCB. To return to the select test menu, follow the instructions shown at the bottom of the screen.

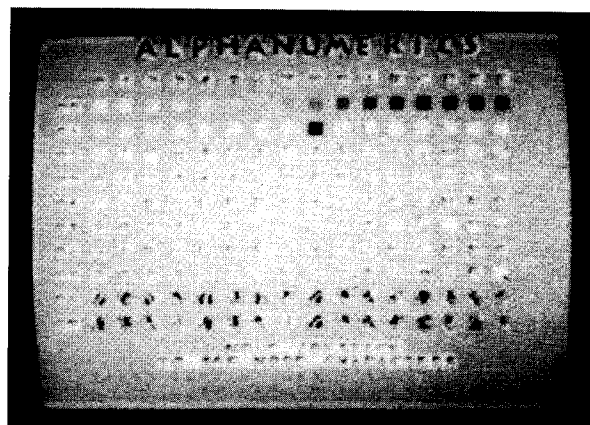

Figure 2-14 Alphanumeric Test Screen

## Monitor Tests

The monitor test selection screen lets you select from three screens — color, purity, and convergence. Advance to each screen to completely test the monitor.

### Color Test

The color test (see Figure 2-15) indicates the dynamic range of the video display color circuitry. The screen should show three bands (red, green, and blue) in the left half, plus white in the right half, ranging from

black to white, from left to right. The red, green, and blue bands are produced by only one color gun being turned on in each band.

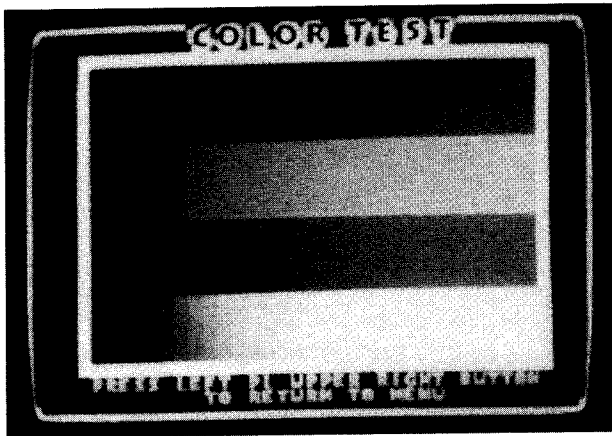

**Figure 2-15 Color Test Screen**

### Purity Test

The next five screens are color purity tests. The entire screen will be red (see Figure 2-16), green, blue, white, and grey. Press the Left player upper Left button to change colors. Each screen should show no unevenness of color and no lines in the display.

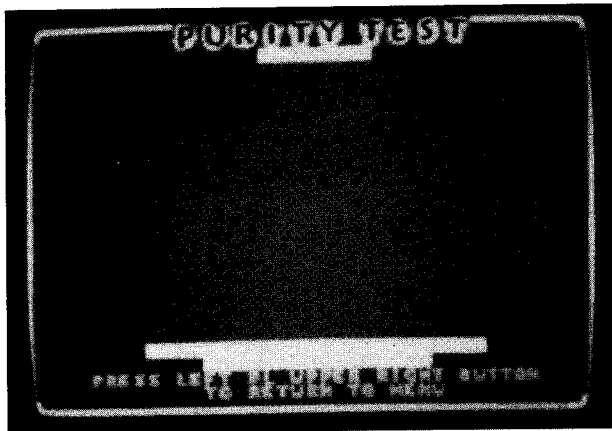

**Figure 2-16 Purity Test Screen**

### Convergence Test

The convergence test has three screens — white, violet, and green backgrounds with grid lines. This sequence is then repeated but without any text on the screen. The green screen is shown in Figure 2-17. To see the remaining screens or return to the select test menu, follow the instructions shown at the bottom of the screen.

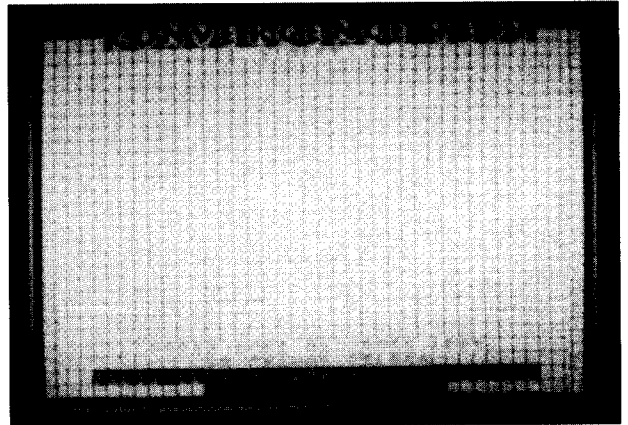

**Figure 2-17 Convergence Test Screen**

Check the following on the screens:

- The grid lines should be straight within 3.0 mm and the lines should not pincushion or barrel.
- The convergence of the lines on the violet and green screens should be within 2.0 mm.

If these screens do not meet these criteria, adjust the video display as described in the video display manual.

Return to the select test menu by pressing the thumb button.

Causes of errors could be problems with the cable, terminators installed incorrectly, harnesses, or connectors.



# Troubleshooting & Maintenance

## Introduction

**T**HIS CHAPTER contains maintenance, troubleshooting and repair procedures for your Primal Rage™ game. The maintenance section gives information on cleaning the parts. The troubleshooting section contains several tables to help determine the source of a problem and the steps necessary to repair it. The repair section contains the steps necessary to remove and install the serviceable parts. Together, these three sections provide a complete guide to servicing your Primal Rage™ game.



# Maintenance Procedures

## Introduction

This section describes the maintenance procedures for all of the major assemblies and components of the game. The maintenance procedures should be performed every 3–4 months on a regular basis.

### WARNING

*Before performing any maintenance or repairs, please observe all of the following safety precautions:*

1. Turn the game's power off.
2. Unplug the power cord from the electrical socket.
3. Secure loose clothing such as ties and long sleeves that could get caught within the game.
4. Remove all metal jewelry such as watches and necklaces that could conduct electricity from the game's power sources.

## Cleaning Procedure for Coin Mechanisms

Regular use of the coin mechanisms may result in a build-up of residue and dirt. If this is the case, clean the coin mechanism by following the steps below (refer to Figure 4-6 for detailed part information on the coin door).

1. Open the upper coin door.
2. Open the gate on the door that covers the magnet. Use the blade of a screwdriver to scrape away any metal filings that have collected on the magnet.
3. Clean the loose dust and dirt from the coin mechanism with a lint-free rag or a soft brush.
4. Clean the dirt and residue from the coin path with a toothbrush. Hot, soapy water may be used to help dissolve dirt and residue.
5. Blow out all the loose dirt and dry the coin mechanism with compressed air.



6. Close the gate on the door that covers the magnet and close the upper coin door.

### CAUTION

*Never lubricate the coin mechanism with oil or grease.*

# Troubleshooting Procedures

This section is designed to help determine the source of a malfunction and detailed information on repairing the problem.

*Table 3-1 General Troubleshooting*, is divided into two columns. The left-hand column is broken down into the general nature of problems. The right-hand column lists suggested solutions to solve the problem.

*Table 3-2 ROMs and RAMs Troubleshooting*, is designed to help determine the specific ROMs and RAMs that are the source of a game logic malfunction. The left-hand column shows some problems that may result from malfunctioning ROMs and RAMs. The middle column shows the ROMs and RAMs that may be the source of the problem and their purposes. The right-hand column shows the PCB locations of the ROMs and RAMs that may be causing the problem.

*Table 3-3 Voltage Inputs and Test Points*, is divided into three columns. The left-hand column shows the correct voltages that should be measured. The middle column shows the physical locations of the test points or LEDs. The right-hand column shows the sources and purposes of the voltages.

# Repair Procedures

## Introduction

This section describes the repair procedures for all of the major assemblies and components of the game. Before performing any repairs, use the tables in the *Troubleshooting Procedures* section to help narrow the source of the problem. The *Maintenance Procedures* section may also provide a good starting point for fixing many game problems before beginning what might be unnecessary repairs.

## Speakers

Each game has three speakers: the two top speakers under the attract panel and a sub-woofer next to the coin door. The speakers provide the music and sounds for the game and self-tests. Failure of the speakers may result in distorted or no sound. If this is the case, replace the speakers by following the removal and installation steps below.

1. Remove the six screws securing the speaker grille; remove the speaker grille and set aside.
2. Remove the four speaker mounting screws.
2. Disconnect the harness from the speaker.
3. Replace and reinstall the speaker in reverse order.

## Attraction Panel Light Bulb

To replace the attraction panel light bulb, follow the removal and installation steps that follow.

1. Partially loosen the six screws securing the speaker grille.
2. Remove the three screws from the attraction panel retainer on top of the cabinet; remove the bracket and set aside.
3. Slide the plastic attraction panel upwards to remove it.
4. Remove the cardboard bulb retaining clips one at a time by pressing on the circular tab and pulling the clip toward you.
5. Rotate the bulb toward you while gently pulling on the bulb to remove it.

## Pot Joysticks

The pot joystick and its handle are shown in Figure 4-4. If you want to repair the joystick control, disassemble it by removing it from the pedestal. The hardware that secures the joystick assembly to the pedestal is also listed in that figure.

## System Logic Assemblies

This section describes the repair and maintenance procedures for the major assemblies and components that are related to the system's logic and electronics, including the printed-circuit boards (PCBs) and the power supply. These components are housed in a slide-out drawer underneath the front access panel.

### **Primal Rage Game PCB Set**

The Primal Rage game PCB set (board stack) is responsible for the display graphics and game play. Failure of the game PCB set may result in erratic or no game play. If this

is the case, repair or replace the game PCB set by following the removal and installation steps below.

1. Remove the two retaining screws securing the control panel.
2. Unlock the control panel and open the panel by pulling toward you.
3. Disconnect the harness connectors from the game PCB set. (There are 5 connectors in all.)
4. Slide the drawer that holds the PCB set toward you. Drawer movement may be hindered by the joystick and button harnesses. If this is the case, disconnect the harnesses.
5. Unfasten the screw and spacer that secures the game PCB set to the drawer. Remove the game PCB set and its attached cover (refer to Figure 4-7).

---

### **CAUTION**

*Before handling static-sensitive components, properly ground yourself to discharge buildup of static charges.*

---

6. Re-install the game PCB set by following the previous steps in the reverse order.

### **Power Supply**

The power supply is responsible for providing power to all of the game assemblies that require it. Failure of the power supply may result in erratic game play or no power at all. If this is the case, repair or replace the power supply assembly by following the steps below.

---

### **WARNING**

*The power supply can contain high voltages even after the power is turned off. To avoid injury, observe all of the safety precautions before working on the power supply. (Refer to the Introduction in the Maintenance Procedures section.)*

---

1. Unlock the rear door of the cabinet and remove it.
2. Disconnect the wiring harnesses from the power supply.
3. Unfasten the 2 screws that secure the power supply assembly to the cabinet, and remove the power supply assembly.
4. Re-install the power supply assembly by following the previous steps in the reverse order.

Problem	Suggested Action												
<b>Coin Mechanism Problem</b>	<ol style="list-style-type: none"> <li>1. Check the wiring connections to the coin mechanism.</li> <li>2. Check the voltage to the + side of the mechanism.</li> <li>3. Test the coin mechanism with the Controls Test screen in the self-test.</li> <li>4. Check the power distribution board fuses.</li> </ol>												
<b>Joystick Problem</b>	<ol style="list-style-type: none"> <li>1. Check the switches and potentiometers using the Controls Test in the self-test.</li> <li>2. Reset the limits on the joystick using the Controls Test in the self-test.</li> <li>3. Has the control been lubricated with the correct type of lubricant? If not, lubricate it as shown in Figure 4-4.</li> <li>4. Check the harnesses and connectors.</li> <li>5. If you took the control apart, have you reassembled it correctly?</li> <li>6. Make sure all the parts of the control are in good order. Repair or replace parts as needed.</li> </ol>												
<b>Sound Problem</b>	<ol style="list-style-type: none"> <li>1. Check the speaker volume setting: make sure the volume isn't zero!</li> <li>2. Check both parts of the Sound Board Test in the self-test.</li> <li>3. Check the voltage on the JXPWR connector.</li> <li>4. Check the connections from the Quad Amp PCB to the speakers.</li> <li>5. Check the audio ROMs' checksums in the Sound Board Test of the self-test procedure.</li> <li>6. Check the resistance of the speakers for 8 Ohms on the 4-inch speakers and 4 Ohms on the 8-inch woofer next to the coin box.</li> </ol>												
<b>Video Display Problem</b>	<table border="0"> <tr> <td data-bbox="100 947 562 977">Screen is dark</td> <td data-bbox="577 947 1432 1300"> <ol style="list-style-type: none"> <li>1. Check to see that the game is plugged in and powered on.</li> <li>2. Check the line fuse if no power is present.</li> <li>3. Check the display brightness.</li> <li>4. Check the solder connections on the line filter and the transformer.</li> <li>5. Check the edge connector to the PCB.</li> <li>6. Check the harnesses and connectors to the video display PCB.</li> <li>7. Check the voltage levels to the video display PCB.</li> <li>8. Run through the following checklist. If you answer <i>no</i> to any question, you have a problem with the video display, not with the game circuitry. In this case, refer to your video display service manual.               <ol style="list-style-type: none"> <li>a. Do you have power to the video display?</li> <li>b. Are the video display's filaments lit?</li> <li>c. Do you have the correct voltage to the video display?</li> </ol> </li> </ol> </td> </tr> <tr> <td data-bbox="100 1320 562 1350">Only a colored screen appears</td> <td data-bbox="577 1320 1432 1380"> <ol style="list-style-type: none"> <li>1. Attempt to run a complete RAM/ROM test in the self-test.</li> <li>2. Replace the RAM if a RAM failure is reported in the self-test.</li> </ol> </td> </tr> <tr> <td data-bbox="100 1391 562 1421">Picture wavers or is too small</td> <td data-bbox="577 1391 1432 1451"> <ol style="list-style-type: none"> <li>1. Check the voltage levels to the video display PCB.</li> <li>2. Check the B+ to the video display. (Refer to the video display manual.)</li> </ol> </td> </tr> <tr> <td data-bbox="100 1491 562 1522">Attract panel does not light</td> <td data-bbox="577 1491 1432 1552"> <ol style="list-style-type: none"> <li>1. Check the bulb in the attract panel.</li> <li>2. Check the Power Distribution Board fuses.</li> </ol> </td> </tr> <tr> <td data-bbox="100 1572 562 1602">Picture is wavy</td> <td data-bbox="577 1572 1432 1632"> <ol style="list-style-type: none"> <li>1. Check the connection of the monitor ground wire to the monitor.</li> <li>2. Check the connections of the sync inputs.</li> </ol> </td> </tr> <tr> <td data-bbox="100 1643 562 1673">Picture is upside down or reversed</td> <td data-bbox="577 1643 1432 1703"> <ol style="list-style-type: none"> <li>1. If you replaced the monitor recently, check the horizontal or vertical yoke wire connections to the video display. They may be switched.</li> </ol> </td> </tr> </table>	Screen is dark	<ol style="list-style-type: none"> <li>1. Check to see that the game is plugged in and powered on.</li> <li>2. Check the line fuse if no power is present.</li> <li>3. Check the display brightness.</li> <li>4. Check the solder connections on the line filter and the transformer.</li> <li>5. Check the edge connector to the PCB.</li> <li>6. Check the harnesses and connectors to the video display PCB.</li> <li>7. Check the voltage levels to the video display PCB.</li> <li>8. Run through the following checklist. If you answer <i>no</i> to any question, you have a problem with the video display, not with the game circuitry. In this case, refer to your video display service manual.               <ol style="list-style-type: none"> <li>a. Do you have power to the video display?</li> <li>b. Are the video display's filaments lit?</li> <li>c. Do you have the correct voltage to the video display?</li> </ol> </li> </ol>	Only a colored screen appears	<ol style="list-style-type: none"> <li>1. Attempt to run a complete RAM/ROM test in the self-test.</li> <li>2. Replace the RAM if a RAM failure is reported in the self-test.</li> </ol>	Picture wavers or is too small	<ol style="list-style-type: none"> <li>1. Check the voltage levels to the video display PCB.</li> <li>2. Check the B+ to the video display. (Refer to the video display manual.)</li> </ol>	Attract panel does not light	<ol style="list-style-type: none"> <li>1. Check the bulb in the attract panel.</li> <li>2. Check the Power Distribution Board fuses.</li> </ol>	Picture is wavy	<ol style="list-style-type: none"> <li>1. Check the connection of the monitor ground wire to the monitor.</li> <li>2. Check the connections of the sync inputs.</li> </ol>	Picture is upside down or reversed	<ol style="list-style-type: none"> <li>1. If you replaced the monitor recently, check the horizontal or vertical yoke wire connections to the video display. They may be switched.</li> </ol>
Screen is dark	<ol style="list-style-type: none"> <li>1. Check to see that the game is plugged in and powered on.</li> <li>2. Check the line fuse if no power is present.</li> <li>3. Check the display brightness.</li> <li>4. Check the solder connections on the line filter and the transformer.</li> <li>5. Check the edge connector to the PCB.</li> <li>6. Check the harnesses and connectors to the video display PCB.</li> <li>7. Check the voltage levels to the video display PCB.</li> <li>8. Run through the following checklist. If you answer <i>no</i> to any question, you have a problem with the video display, not with the game circuitry. In this case, refer to your video display service manual.               <ol style="list-style-type: none"> <li>a. Do you have power to the video display?</li> <li>b. Are the video display's filaments lit?</li> <li>c. Do you have the correct voltage to the video display?</li> </ol> </li> </ol>												
Only a colored screen appears	<ol style="list-style-type: none"> <li>1. Attempt to run a complete RAM/ROM test in the self-test.</li> <li>2. Replace the RAM if a RAM failure is reported in the self-test.</li> </ol>												
Picture wavers or is too small	<ol style="list-style-type: none"> <li>1. Check the voltage levels to the video display PCB.</li> <li>2. Check the B+ to the video display. (Refer to the video display manual.)</li> </ol>												
Attract panel does not light	<ol style="list-style-type: none"> <li>1. Check the bulb in the attract panel.</li> <li>2. Check the Power Distribution Board fuses.</li> </ol>												
Picture is wavy	<ol style="list-style-type: none"> <li>1. Check the connection of the monitor ground wire to the monitor.</li> <li>2. Check the connections of the sync inputs.</li> </ol>												
Picture is upside down or reversed	<ol style="list-style-type: none"> <li>1. If you replaced the monitor recently, check the horizontal or vertical yoke wire connections to the video display. They may be switched.</li> </ol>												

**Table 3-1 General Troubleshooting**

Problem	Suggested Action
Convergence, purity or color problems	<ol style="list-style-type: none"> <li>1. Use the self-test mode to digitally adjust the video display.</li> <li>2. Use the adjustment procedures in your video display manual.</li> </ol>
Picture is not centered	<ol style="list-style-type: none"> <li>1. Use the centering procedures in your video display manual.</li> </ol>

**Table 3-1 General Troubleshooting, Continued****ROMs/RAMs**

The ROMs and RAMs contain the programming routines used by the game PCB set to control game play. Refer to *Table 3-2 ROMs and RAMs Troubleshooting* to determine the ROMs or RAMs that are malfunctioning. Replace the damaged ROMs or RAMs by following the removal and installation steps below.

1. Remove the game PCB set according to the procedure in the *Primal Rage Game PCB Set* section.

**CAUTION**

*Before handling static-sensitive components, properly ground yourself to discharge buildup of static charges.*

2. Remove the damaged ROMs and RAMs from the game PCB set using a chip extraction tool.
3. Install the new ROMs and RAMs by plugging them in the game PCB set sockets.
4. Re-install the game PCB set by following the steps in the *Primal Rage Game PCB Set* section in the reverse order.

Problem	ROMs/RAMs Source and Purpose	Location
<b>ROMs</b>		
The program works, but the motion objects are incorrect or non-existent.	Motion Object ROMs and GALs (responsible for moving graphic objects)	1S, 11S–15S, 9T, 17P, 22U. Also, ROMs on rows V, W
Garbage appears on the screen or game play doesn't work correctly.	Program ROMs (responsible for game control)	24L–29L
The text or numbers are incorrect or non-existent.	Alphanumeric ROM (responsible for controlling graphic text and numbers)	22P/R
The sound is incorrect or non-existent.	Audio ROMs (responsible for controlling sound)	ROMs on Row 11 of Sound CH31 board.
The moving backgrounds graphics are incorrect or non-existent.	Playfield ROMs (responsible for controlling background graphics)	25N–28N
<b>RAMs</b>		
The display color is yellow.	Working RAM	
The display color is green.	Video RAM	
The display color is white.	Color RAM	

**Table 3-2 ROMs and RAMs Troubleshooting**

Voltage	Test Point or LED Location	Voltage Source and Purpose
+5 ± 0.25 VDC	+5V Low, 5V High	Logic power from the switching power supply.
-5 V	-V0P (pin 11 of LM324)	-5 V from the switching power supply (if connected).

**Table 3-3 Voltage Inputs and Test Points**

## Video Display

To repair, replace or make adjustments to the video display, follow the removal and installation steps below.

### **WARNING**

#### **High Voltage**

*The video display contains lethal high voltages. To avoid injury, do not service this display until you observe all precautions necessary for working on high-voltage equipment.*

#### **X-Radiation**

*This video display is designed to minimize X-radiation. However, to avoid possible exposure to soft X-radiation, never modify the high-voltage circuitry.*

#### **Implosion Hazard**

*The cathode-ray tube (CRT) may implode if struck or dropped. The shattered glass from the tube may cause injury up to six feet away. Use care when handling the display and when removing it from the game cabinet. Also, wear gloves to protect your hands from the sheet-metal edges.*

1. Unfasten the 8 square drive screws that secure the monitor door to the cabinet and remove them.
2. Discharge the high-voltage from the cathode-ray tube (CRT).

### **NOTE**

*The label on the video display assembly shows a circuit for discharging the high-voltage contained in the CRT to ground when the power is off.*

- a. Secure one end of a solid 18-gauge wire to a well-insulated or wooden handle screwdriver.
- b. Secure the other end of the wire to an earth ground.

- c. Briefly touch the blade end of the screwdriver to the CRT anode by sliding it under the anode cap.
  - d. Wait 2 minutes and repeat the previous step.
3. Disconnect all of the wire harnesses from the video display.
  4. Unfasten the square-drive screws that secure the light housing assembly and remove it.
  5. Unfasten the square-drive screws that secure the lower glass retainer. Remove the display shield and cardboard bezels.
  6. Unfasten the 4 flat washers and nuts that secure the video display chassis to the cabinet monitor mounting brackets.
  7. Remove the video display assembly from the cabinet.

### **CAUTION**

*Do not attempt to remove the video display without its chassis.*

8. Install the new video display by following the previous steps (excluding steps 2a.–2d.) in the reverse order.
9. If necessary, adjust the new video display's brightness, size, centering, purity and convergence according to the video display service manual.

### **CAUTION**

*The low-impedance (75Ω) Neotec NT-2515C monitor (used in the Atari Games standard upright cabinet) and high-impedance Hantarex Polo 33" monitor (used in the Showcase 33 cabinet) are **not** interchangeable. If you do plan to replace an existing monitor with the other type, you must change resistors in the video driver circuits on the Primal Rage game PCB. Refer to the game PCB schematic on page 5-6 for more details.*



# Parts Illustrations

## Part Ordering Information

**T**HIS CHAPTER provides information you need to order parts for your game. The printed-circuit board (PCB) parts lists are arranged in alphabetical order by component. Within each section the parts are arranged numerically by part number. When you order parts, give the part number, part name, the number of this manual, and the serial number of your game. With this information, we can fill your order rapidly and correctly. We hope this will create less downtime and more profit from your games. Atari Games Customer Service phone numbers are listed on the inside front cover of this manual.



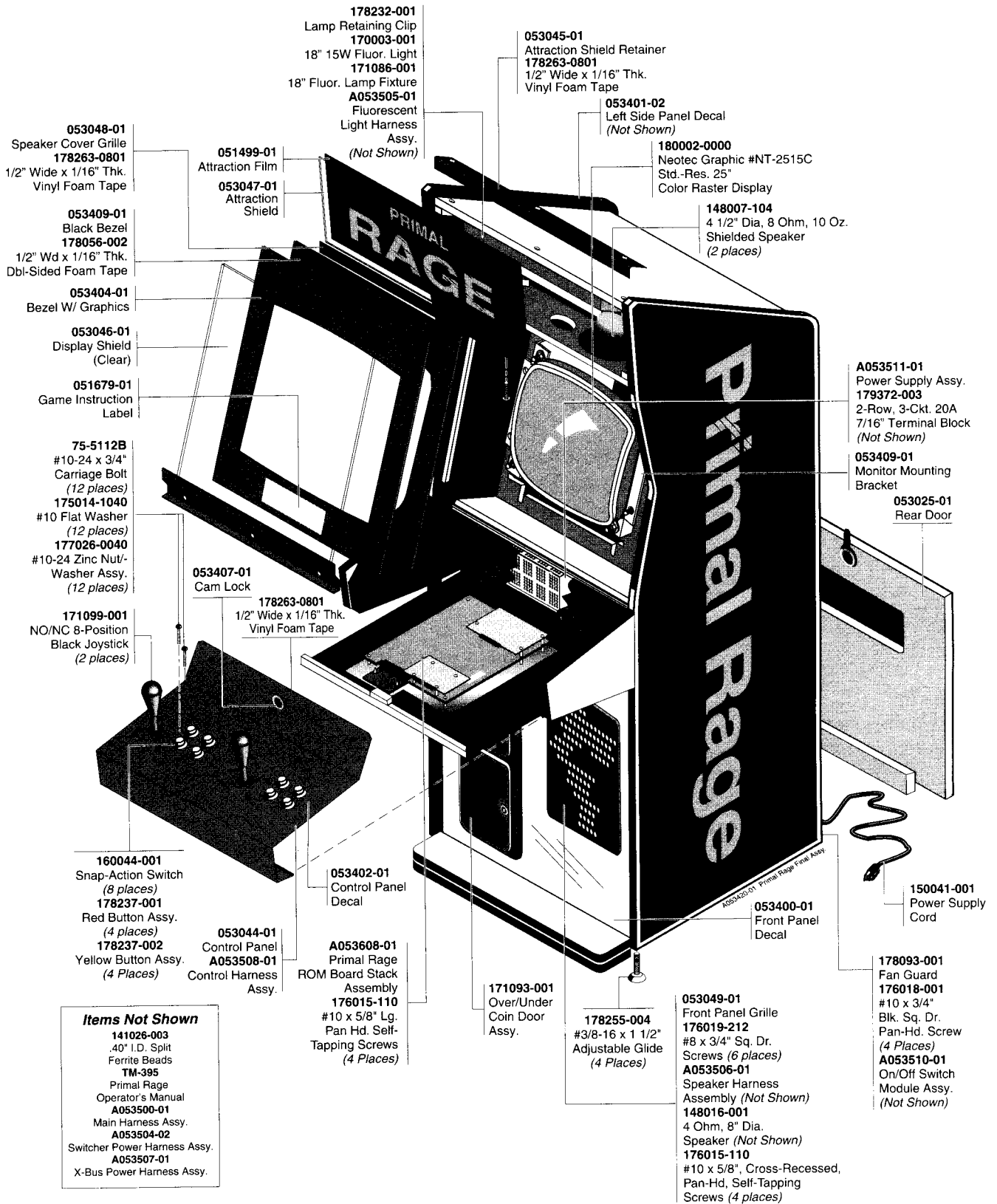

**Figure 4-1 Cabinet Overview**

A053420-01 A

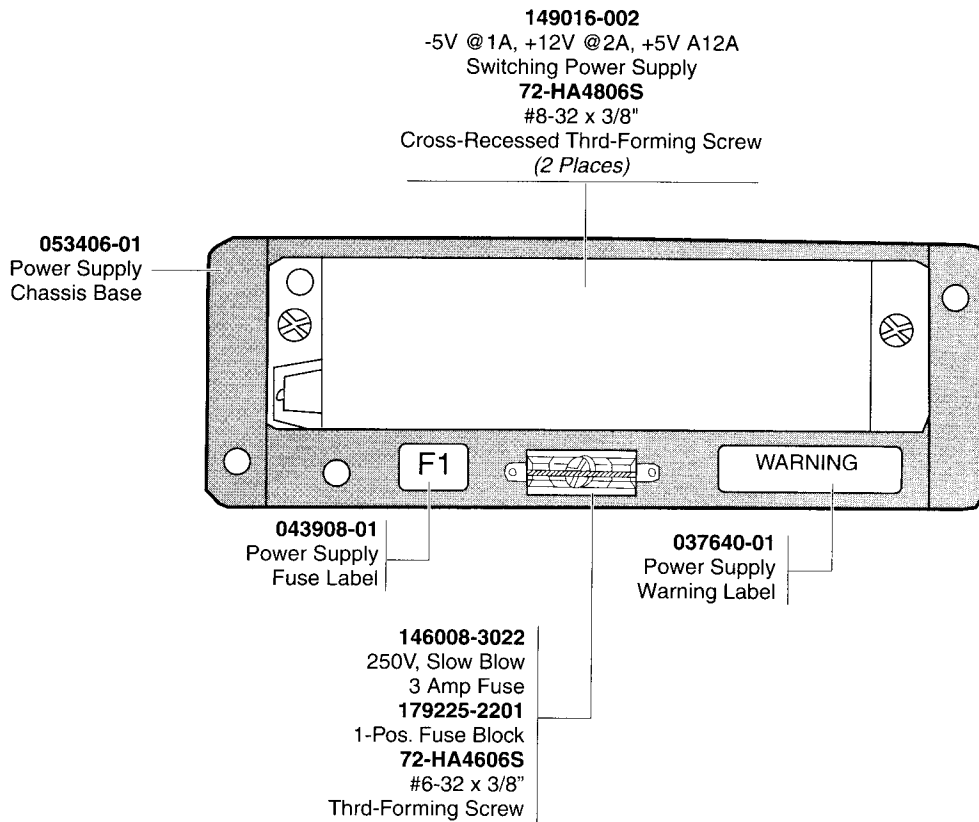

**Figure 4-2 Power Supply Assembly**

A053511-01

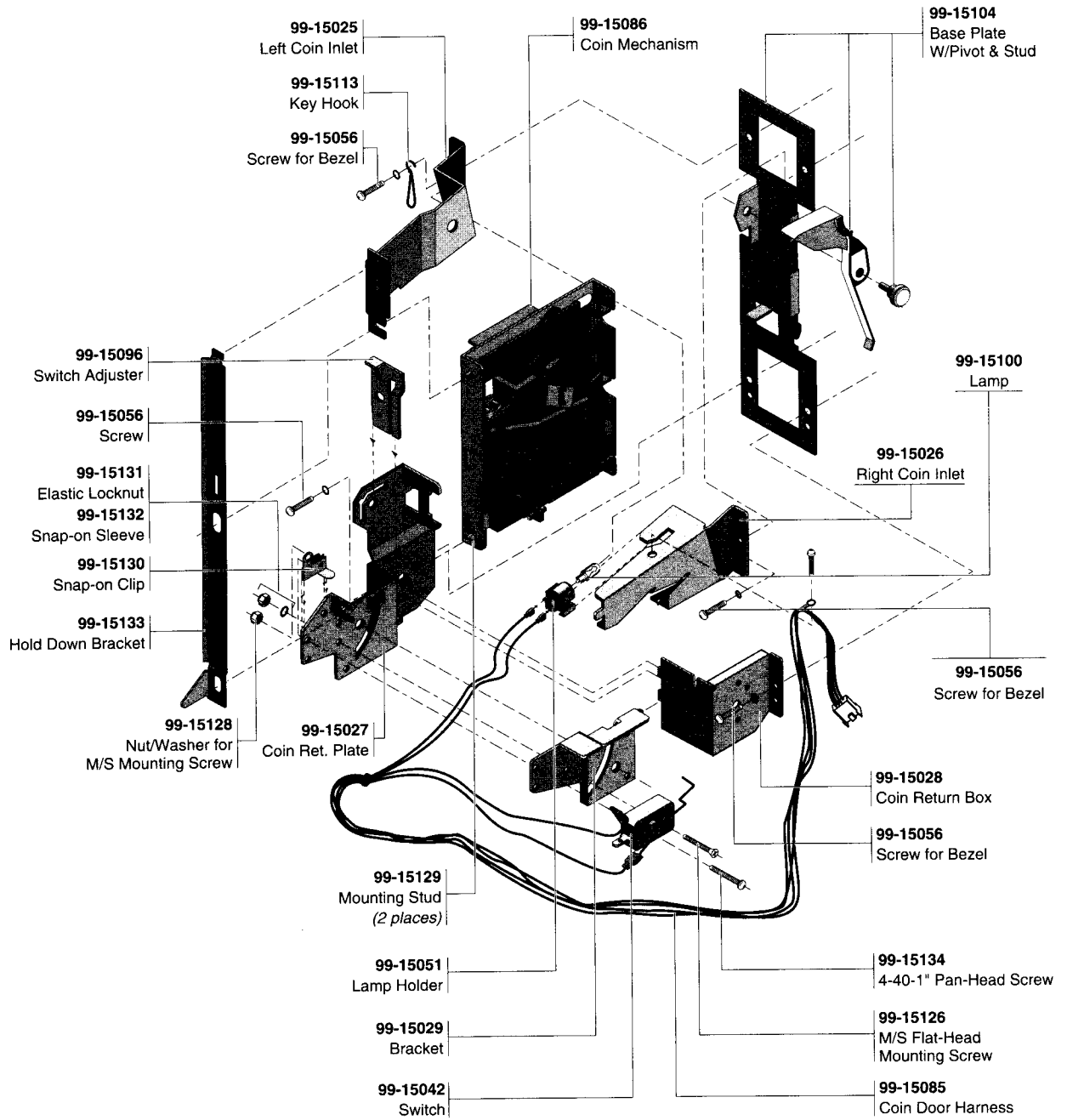

**Figure 4-3 Over/Under Coin Door Assembly**

171093-001

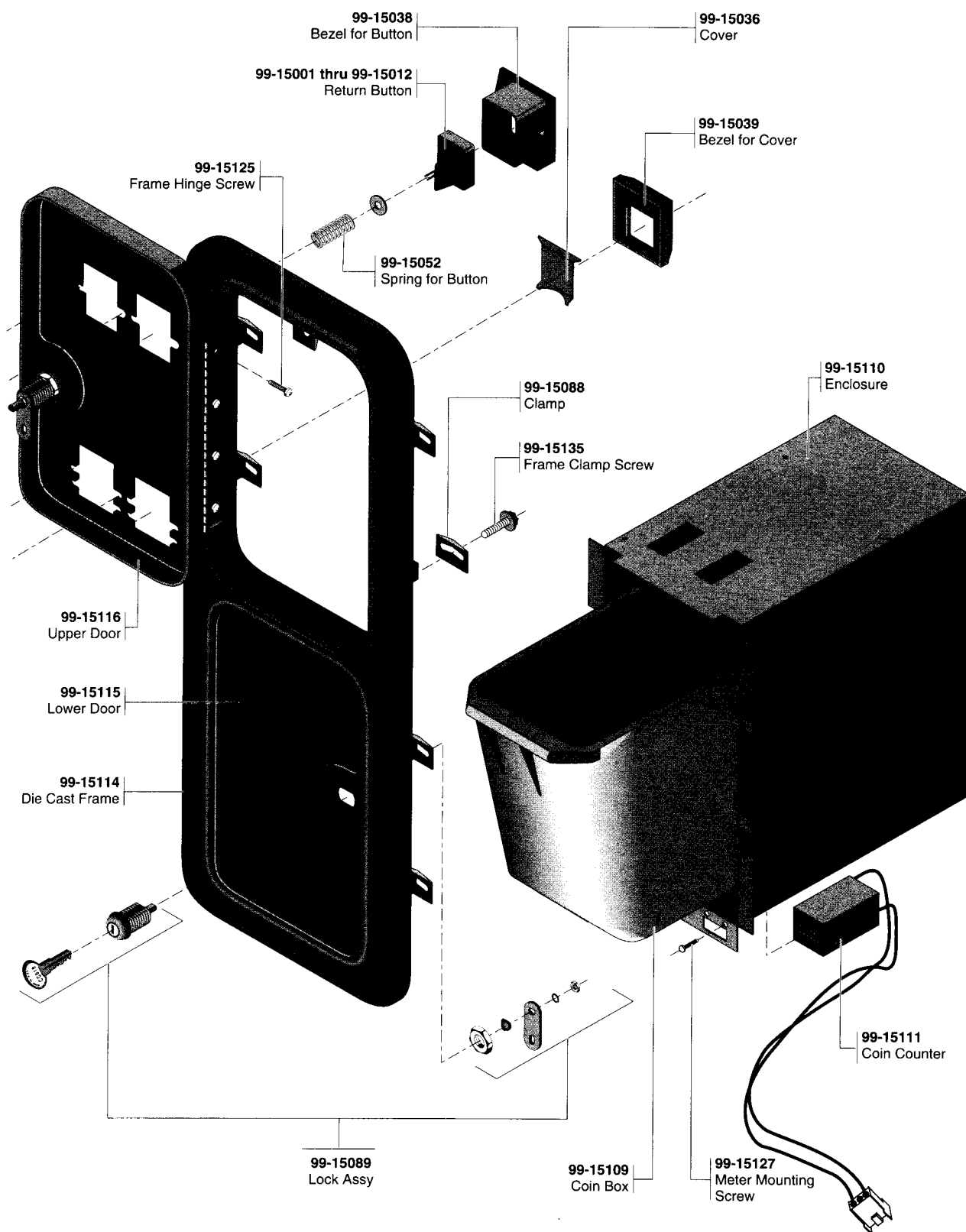

**Figure 4-3 Over/Under Coin Door Assembly**

171093-001

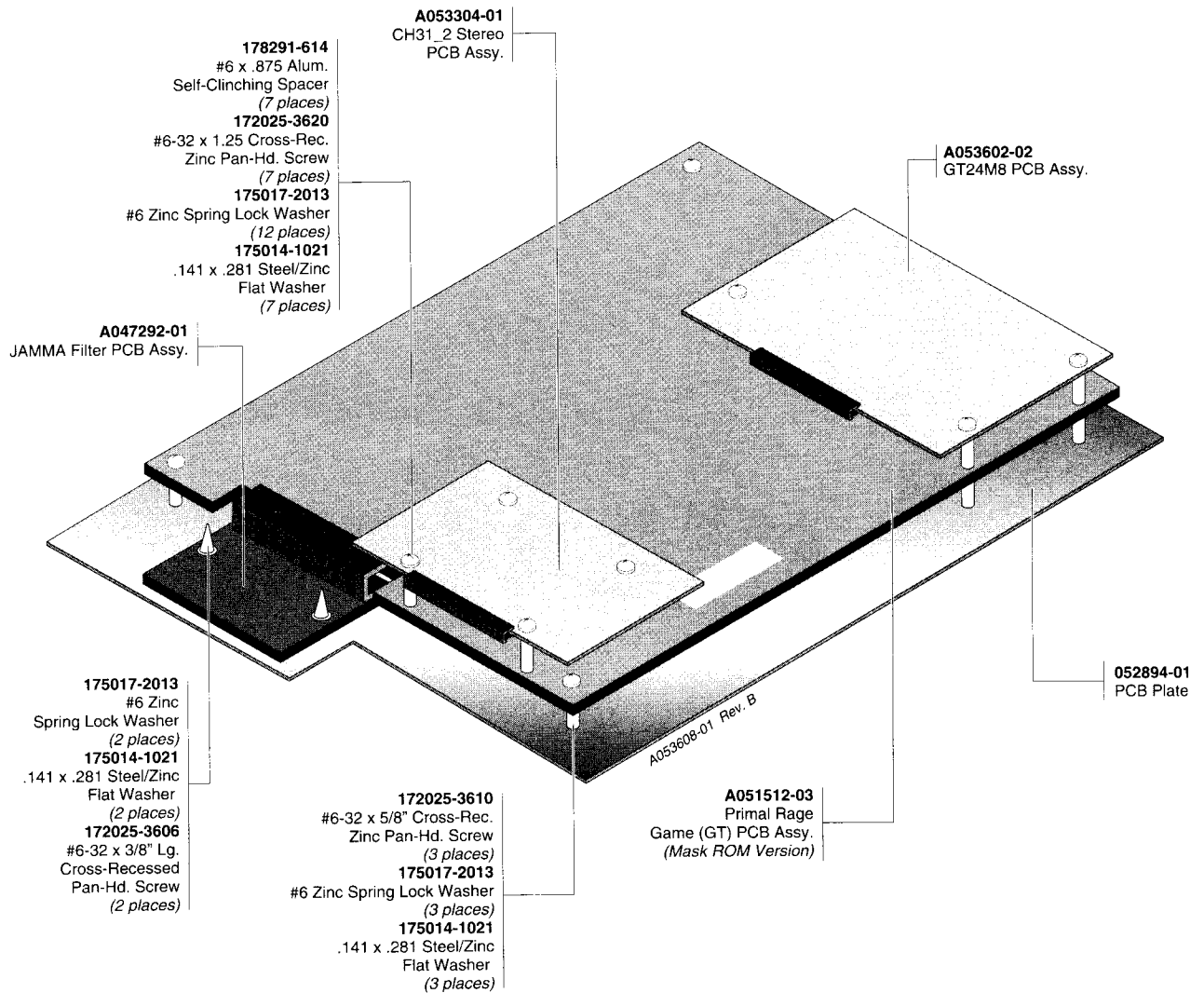

**Figure 4-4 Board Stack Assembly**

A053399-02 A

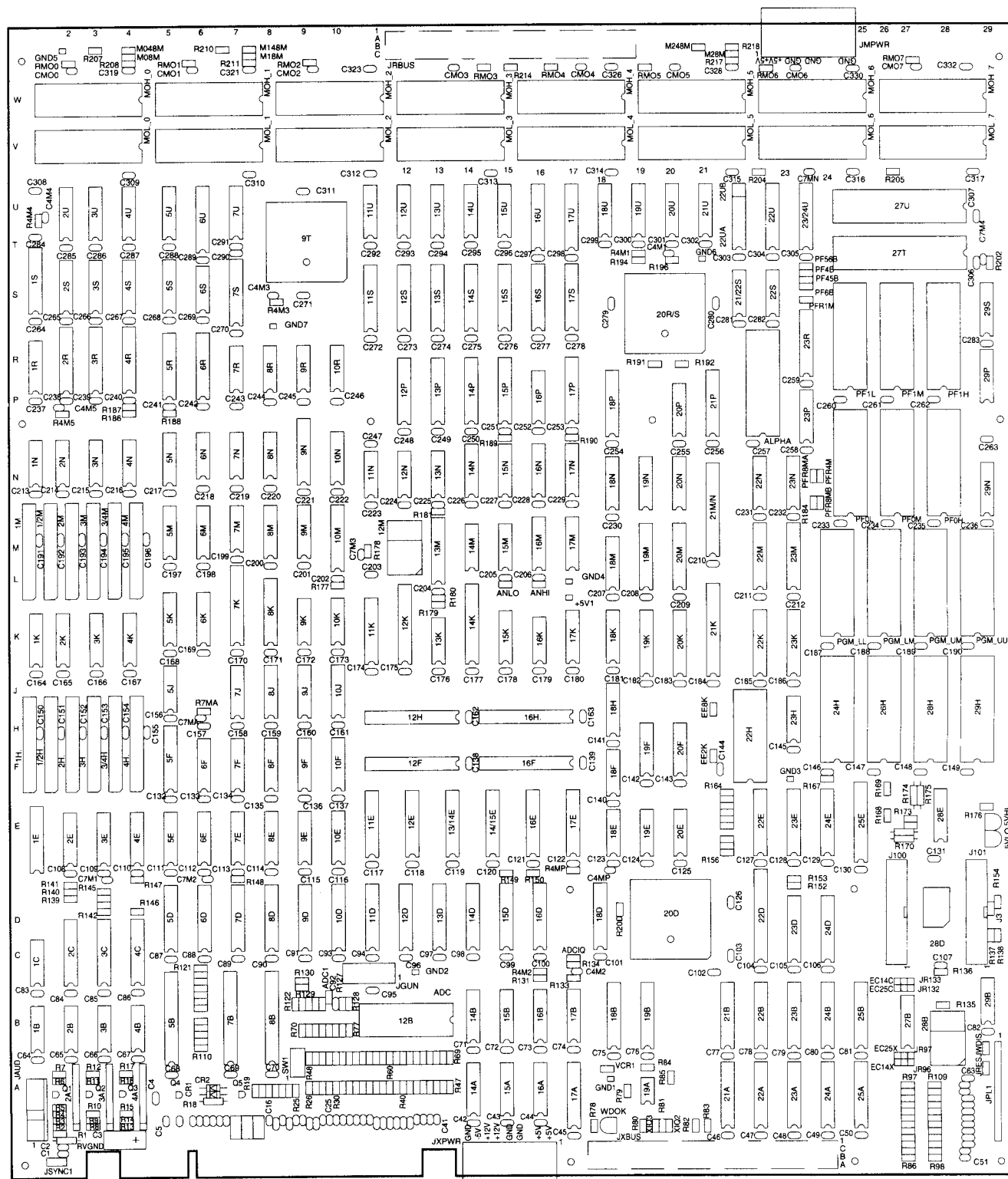

**NOTE:** For best display quality, use this game PCB (from an Atari Games standard upright cabinet) only with a Neotec monitor. Do not install this game PCB into a Showcase 33 Deluxe cabinet.

**Figure 4-5 Primal Rage Game (GT) PCB Assembly**

A051512-03 A

## Primal Rage Game PCB Assembly Parts List

Designator	Description	Part No.	Designator	Description	Part No.
1/2H, 1/2M,			1	Pr, EPROM, 512KX8, 100 ns, Pgm Uu Xxxx	136102-0044
1H., 1M	Socket, Zip 28	179302-028			
1S	Socket, 20 Pin, .300, Dbl Wipe	179356-0320			
2H., 2M, 3/4H, 3/4M, 3H, 3M, 4H., 4M			1	Pr, EPROM, 512KX8, 100 ns, Moh 0 1C39	136102-0301
	Socket, Zip 28	179302-028	1	Pr, EPROM, 512KX8, 100 ns, Mol 0 2C11	136102-0300
5B	Socket, 28 Pin, .300, Dbl Wipe	179356-0328	1	Pr, EPROM, 512KX8, 150 ns, PF0M Xxxx	136102-0051
			1	Pr, EPROM, 512KX8, 150 ns, PF0L Xxxx	136102-0050
5F	Socket, 20 Pin, .300, Dbl Wipe	179356-0320			
5N	Socket, 16 Pin, .300, Dbl Wipe	179356-0316	1	Pr, EPROM, 512KX8, 150 ns, PF0H Xxxx	136102-0052
7B	Socket, 28 Pin, .300, Dbl Wipe	179356-0328	1	Pr, EPROM, 512KX8, 100 ns, Pgm Ll Xxxx	136102-0041
7K	Socket, 24 Pin, .300, Dbl Wipe	179356-0324	1	Pr, EPROM, 512KX8, 100 ns, Pgm Um Xxxx	136102-0043
8B	Socket, 28 Pin, .300, Dbl Wipe	179356-0328	1/2M	Integrated Circuit, VRAM, 256KX4, 100 ns	137682-100
8K, 9N	Socket, 20 Pin, .300, Dbl Wipe	179356-0320			
9T	Socket, 68 Pin, PGA for 68PLCC Integrated Circuit	179237-068	1B	Integrated Circuit, 74LS11	137149-001
10M,11K,11S	Socket, 20 Pin, .300, Dbl Wipe	179356-0320	1C	Integrated Circuit, 7406	137052-001
			1E	Integrated Circuit, 74LS244	137038-001
12B	Socket, 28 Pin, .600, Dbl Wipe	179356-0628	1K	Integrated Circuit, 74F157	137494-001
12F, 12H	Socket, 28 Pin, .300, Dbl Wipe	179356-0328			
12K	Socket, 24 Pin, .300, Dbl Wipe	179356-0324	1M	Integrated Circuit, VRAM, 256KX4, 100 ns	137682-100
12S,13M,13S	Socket, 20 Pin, .300, Dbl Wipe	179356-0320	1N	Integrated Circuit, 74F08	137483-001
			1R	Integrated Circuit, 74F163	137345-001
14K	Socket, 24 Pin, .300, Dbl Wipe	179356-0324	2A	Res, R2R10, 1K/2K, SIP10	118015-001
14S, 15S	Socket, 20 Pin, .300, Dbl Wipe	179356-0320			
16F, 16H.	Socket, 28 Pin, .300, Dbl Wipe	179356-0328	2B	Integrated Circuit, 74LS27	137062-001
17P, 17S	Socket, 20 Pin, .300, Dbl Wipe	179356-0320	2C	Integrated Circuit, 74HCT273	137655-001
			2E	Integrated Circuit, 74LS157	137029-001
20D, 20R/S	Socket, 68 Pin, PGA for 68PLCC Integrated Circuit	179237-068	2K	Integrated Circuit, 74F157	137494-001
21K, 21M/N	Socket, 28 Pin, .300, Dbl Wipe	179356-0328	2M	Integrated Circuit, VRAM, 256KX4, 100 ns	137682-100
22A	Socket, 20 Pin, .300, Dbl Wipe	179356-0320	2N	Integrated Circuit, 74F08	137483-001
22D	Socket, 28 Pin, .300, Dbl Wipe	179356-0328	2R	Integrated Circuit, 74LS377	137145-001
			2S	Integrated Circuit, 74F378	137612-001
22E	Socket, 20 Pin, .300, Dbl Wipe	179356-0320			
22H	Socket, 24 Pin, .600 Dbl Wipe	179356-0624	2U	Integrated Circuit, 74F163	137345-001
22UB, 23E,			3/4M	Integrated Circuit, VRAM, 256KX4, 100 ns	137682-100
24E	Socket, 20 Pin, .300, Dbl Wipe	179356-0320	3A	Res, R2R10, 1K/2K, SIP10	118015-001
24H	Socket, 32 Pin, .600, Dbl Wipe	179356-0632	3B	Integrated Circuit, 74LS27	137062-001
25E	Socket, 24 Pin, .300, Dbl Wipe	179356-0324	3C	Integrated Circuit, 74HCT273	137655-001
26H	Socket, 32 Pin, .600, Dbl Wipe	179356-0632	3E	Integrated Circuit, 74LS157	137029-001
27T, 27U	Socket, 40 Pin, .600, Dbl Wipe	179356-0640	3K	Integrated Circuit, 74F157	137494-001
28H, 29H	Socket, 32 Pin, .600, Dbl Wipe	179356-0632	3M	Integrated Circuit, VRAM, 256KX4, 100 ns	137682-100
JXBUS	Shroud, 96CKT DIN41621	179369-0096	3N	Integrated Circuit, 74F08	137483-001
++1005V1	Test Point	179051-001	3R	Integrated Circuit, 74F377	137622-001
			3S	Integrated Circuit, 74F157	137494-001
1	Pr, 1020-68PLCC Fpga, 20D Xxxx	136101-1005	3U	Integrated Circuit, 74F378	137612-001
1	Pr, EPROM, 128KX8, 100 ns, Alpha Xxxx	136102-0045			
1	Pr, EPROM, 512KX8, 100 ns, Pgm Lm Xxxx	136102-0042	4A	Res, R2R10, 1K/2K, SIP10	118015-001
			4B	Integrated Circuit, 74LS27	137062-001



## T-MEK Game PCB Assembly, Continued

### Parts List

Designator	Description	Part No.	Designator	Description	Part No.
4C	Integrated Circuit, 74HCT273	137655-001	10D	Integrated Circuit, 74F374	137420-001
4E	Integrated Circuit, 74LS157	137029-001	10E	Integrated Circuit, 74LS157	137029-001
4K	Integrated Circuit, 74F157	137494-001	10F, 10J	Integrated Circuit, 74F153	137492-001
4M	Integrated Circuit, VRAM, 256KX4, 100 ns	137682-100	10K	Integrated Circuit, 74LS86	137079-001
4N	Integrated Circuit, 74F32	137486-001	10N	Integrated Circuit, 74LS163 A	137114-001
4R	Integrated Circuit, 74LS377	137145-001	10R	Integrated Circuit, 74F04	137437-001
4S	Integrated Circuit, 74F157	137494-001	11D, 11E	Integrated Circuit, 74F273	137610-001
4U	Integrated Circuit, 74F163	137345-001	11N	Integrated Circuit, 74F04	137437-001
5D	Integrated Circuit, 74LS245	137134-001	11U	Integrated Circuit, 74F163	137345-001
5E	Integrated Circuit, 74LS157	137029-001	12D, 12E	Integrated Circuit, 74F374	137420-001
5J	Integrated Circuit, 74F08	137483-001	12H	Integrated Circuit, SRAM, 32KX8, 25 ns, .3	137670-025
5K, 5M	Integrated Circuit, 74F157	137494-001	12M	Crystal, 28.636 MHz, Osc. Module	144008-009
5R	Integrated Circuit, 74LS244	137038-001	12N	Integrated Circuit, 74F74	137436-001
5S, 5U	Integrated Circuit, 74F169	137496-001	12P	Integrated Circuit, 74F273	137610-001
5VHI,5VLO	LED, Red, T1-3/4, Diffused, .5MCD, 80-Deg	138021-001	12U	Integrated Circuit, 74F163	137345-001
6D	Integrated Circuit, 74F374	137420-001	13/14E,13D	Integrated Circuit, 74LS245	137134-001
6E	Integrated Circuit, 74LS157	137029-001	13K	Integrated Circuit, 74F32	137486-001
6F, 6K, 6M	Integrated Circuit, 74F157	137494-001	13N	Integrated Circuit, 74F74	137436-001
6N	Integrated Circuit, 74F32	137486-001	13P	Integrated Circuit, 74F374	137420-001
6R	Integrated Circuit, 74LS244	137038-001	13U	Integrated Circuit, 74F163	137345-001
6S	Integrated Circuit, 74F260	137570-001	14/15E	Integrated Circuit, 74F273	137610-001
6U	Integrated Circuit, 74F377	137622-001	14A, 14B	Integrated Circuit, 74LS257	137136-001
7D	Integrated Circuit, 74LS245	137134-001	14D	Integrated Circuit, 74F273	137610-001
7E	Integrated Circuit, 74LS157	137029-001	14M	Integrated Circuit, 74F00	137327-001
7F, 7J	Integrated Circuit, 74F153	137492-001	14N	Integrated Circuit, 74F157	137494-001
7M	Integrated Circuit, 74LS74	137023-001	14P	Integrated Circuit, 74F374	137420-001
7N	Integrated Circuit, 74F32	137486-001	14U	Integrated Circuit, 74F163	137345-001
7R	Integrated Circuit, 74F08	137483-001	15A, 15B	Integrated Circuit, 74LS257	137136-001
7S	Integrated Circuit, 74F377	137622-001	15D	Integrated Circuit, 74F374	137420-001
7U	Integrated Circuit, 74F169	137496-001	15K	Integrated Circuit, 74F153	137492-001
8D	Integrated Circuit, 74F374	137420-001	15M	Integrated Circuit, 74F86	137649-001
8E	Integrated Circuit, 74LS157	137029-001	15N	Integrated Circuit, 74F153	137492-001
8F, 8J	Integrated Circuit, 74F153	137492-001	15P	Integrated Circuit, 74F374	137420-001
8M	Integrated Circuit, 74F174	137531-001	15U	Integrated Circuit, 74F163	137345-001
8N	Integrated Circuit, 74F08	137483-001	16A, 16B	Integrated Circuit, 74LS257	137136-001
8R	Integrated Circuit, 74F02	137481-001	16D	Integrated Circuit, 74LS245	137134-001
9D	Integrated Circuit, 74LS245	137134-001	16E	Integrated Circuit, 74F374	137420-001
9E	Integrated Circuit, 74LS157	137029-001	16H.	Integrated Circuit, SRAM, 32KX8, 25 ns, .3	137670-025
9F, 9J	Integrated Circuit, 74F153	137492-001	16K	Integrated Circuit, 74LS04	137009-001
9K	Integrated Circuit, 74F260	137570-001	16M, 16N	Integrated Circuit, 74F153	137492-001
9M	Integrated Circuit, 74F163	137345-001			
9R	Integrated Circuit, 74F00	137327-001			

## Primal Rage Game PCB Assembly, Continued

### Parts List

Designator	Description	Part No.	Designator	Description	Part No.
16P	Integrated Circuit, 74F151	137490-001	23A	Integrated Circuit, 74LS244	137038-001
16S	Integrated Circuit, 74F374	137420-001	23B	Integrated Circuit, 74LS273	137040-001
16U	Integrated Circuit, 74F244	137502-001			
17A	Integrated Circuit, 74LS273	137040-001	23D	Integrated Circuit, 74LS245	137134-001
			23H	Integrated Circuit, 74F32	137486-001
17B	Integrated Circuit, 74LS148	137417-001	23K, 23M	Integrated Circuit, 74LS374	137144-001
17E	Integrated Circuit, 74LS245	137134-001	23N	Integrated Circuit, 74LS378	137305-001
17K	Integrated Circuit, 74LS157	137029-001			
17M, 17N	Integrated Circuit, 74F153	137492-001	23P	Integrated Circuit, 74LS157	137029-001
			23R	Integrated Circuit, 74LS377	137145-001
17U	Integrated Circuit, 74F244	137502-001	24A	Integrated Circuit, 74LS245	137134-001
18B, 18D	Integrated Circuit, 74LS245	137134-001	24B, 24D	Integrated Circuit, 74F245	137591-001
18E	Integrated Circuit, 74F04	137437-001			
18F	Integrated Circuit, 74LS74	137023-001	24H	Integrated Circuit, SRAM, 32KX8, 70 ns, .6	137615-070
			25A	Integrated Circuit, 74LS245	137134-001
18H	Integrated Circuit, 74F138	137521-001	25B	Integrated Circuit, 74F245	137591-001
18K, 18M	Integrated Circuit, 74F153	137492-001	26H	Integrated Circuit, SRAM, 32KX8, 70 ns, .6	137615-070
18N	Integrated Circuit, 74LS163 A	137114-001			
18U	Integrated Circuit, 74F163	137345-001	27B	Integrated Circuit, 74F163	137345-001
			27T	Integrated Circuit, SOS	137550-001
19A	Integrated Circuit, DS1232	137762-001	27U	Integrated Circuit, PfhS	137419-104
19B	Integrated Circuit, 74LS273	137040-001	28B	Crystal, 50.000 MHz, Osc. Module	144008-005
19E	Integrated Circuit, 74LS74	137023-001			
19F	Integrated Circuit, 74F138	137521-001	28D	Integrated Circuit, CPU, 68EC020, 25 MHz, 100PQFP	137691-025
19K, 19M	Integrated Circuit, 74LS245	137134-001	28E	Integrated Circuit, LM613	137746-001
19N	Integrated Circuit, 74LS163 A	137114-001	28H	Integrated Circuit, SRAM, 32KX8, 70 ns, .6	137615-070
19U	Integrated Circuit, 74F163	137345-001	29B	Integrated Circuit, 74F20	137530-001
20E	Integrated Circuit, 74F08	137483-001			
			29H	Integrated Circuit, SRAM, 32KX8, 70 ns, .6	137615-070
20F	Integrated Circuit, 74F138	137521-001	29N	Integrated Circuit, 74LS298	137201-001
20K, 20M	Integrated Circuit, 74LS374	137144-001	29P	Integrated Circuit, 74LS153	137104-001
20N	Integrated Circuit, 74LS163 A	137114-001	29S	Integrated Circuit, 74LS298	137201-001
20P	Integrated Circuit, 74LS378	137305-001			
20R/S	Integrated Circuit, CPU, PLCC	137658-101	A	Pr, Fpla, 20NS, 9T 446D	136094-0004
20U	Integrated Circuit, 74F163	137345-001	A	Pr, GAL16V8, 25NS, 11K 72ED	136101-0011
21/22S	Integrated Circuit, 74F04	137437-001	A	Pr, GAL16V8, 10NS, 22UB 3863	136101-1220
21B	Integrated Circuit, 74LS245	137134-001	A	Pr, GAL16V8, 15NS, 22A 2A8 A	136101-0021
			A	Pr, GAL16V8, 15NS, 23E 75C3	136101-0013
21K, 21M/N	Integrated Circuit, SRAM, 32KX8, 25 ns, .3	137670-025	A	Pr, GAL16V8, 25NS, 12S 4A81	136094-0014
21P	Integrated Circuit, 74LS377	137145-001	A	Pr, GAL16V8, 25NS, 9N 5AED	136101-0012
21U	Integrated Circuit, 74F163	137345-001	A	Pr, GAL16V8, 25NS, 17S 3139	136094-0007
22B	Integrated Circuit, 74LS245	137134-001	A	Pr, GAL16V8, 25NS, 13M 5C94	136101-1008
22D	Integrated Circuit, SRAM, 8KX8, 25 ns, .3	137667-025	A	Pr, GAL16V8, 25NS, 17P 270 A	136094-0015
22H	Integrated Circuit, 28C16-200, 200 ns	137648-200	A	Pr, GAL16V8, 25NS, 11S 25F2	136094-0016
22K, 22M	Integrated Circuit, 74LS245	137134-001	A	Pr, GAL16V8, 25NS, 24E 477 A	136101-0018
22N	Integrated Circuit, 74LS378	137305-001	A	Pr, GAL16V8, 10NS, 1S B535	136101-0006
22S	Integrated Circuit, 74F04	137437-001			
22U, 23/24U	Integrated Circuit, 74LS273	137040-001			

## Primal Rage Game PCB Assembly, Continued

### Parts List

Designator	Description	Part No.	Designator	Description	Part No.
A	Pr, GAL16V8, 25NS, 10M 326F	136101-0009			
A	Pr, GAL20V8, 25NS, 7K 9CA6	136101-0019	EC25C, EC25X, EE2K		
A	Pr, GAL22V10, 10NS, 25E D358	136101-0017		Resistor, 10 $\Omega$ , $\pm 5\%$ , 1/8 W	110027-100
A	Pr, GAL22V10, 15NS, 12K 7553	136101-1022			
			GND1-7	Test Point	179051-001
A	Pr, PROM, 82S147, 13S 76B6	136094-0001	J3	Connector, 2 Circuit, Header, .100 Ctr	179048-002
A	Pr, PROM, 82S147, 14S FD85	136094-0002	JAUD	Connector, 6 Ckt, Header, .156 Ctr, Key 3	179213-006
A	Pr, PROM, 82S147, 15S 9B61	136094-0003	JMPWR	Connector, 9 Ckt, Header, .156 Ctr, Rt, Key 3	179165-009
ADC1	Connector, 2 Circuit, Header, .100 Ctr	179048-002	JPL1	Connector, 15 Ckt, Header, .100 Ctr	179118-015
ALPHA	Socket, 32 Pin, .600, Dbl-Wipe	179356-0632	JRBUS	Connector, 96 Ckt, Rcpt, Pressfit, Long	179368-0096
ANLO	Resistor, 10 $\Omega$ , $\pm 5\%$ , 1/8 W	110027-100	JRBUS)	Shroud, 96CKT, DIN41621	179369-0096
B	Pr, GAL16V8, 25NS, 22E B82E	136101-1025	JRES	Connector, 2 Circuit, Header, .100 Ctr	179048-002
B	Pr, GAL16V8, 25NS, 8K 5ADE	136101-0010	JSYNC1	Connector, 3 Ckt, Header, .100 Ctr	179048-003
			JWDIS	Connector, 2 Circuit, Header, .100 Ctr	179048-002
C1, C2	Capacitor, 100 pF, 100 V, $\pm 5\%$ , Ceramic	122016-101	JXBUS	Connector, 96 Ckt, Rcpt, Pressfit, Long	179368-0096
C3	Capacitor, 100 $\mu$ F, 16 V, Electrolytic, Axial	124008-107	JXPWR	Connector, 9 Ckt, Header, .156 Ctr, Rt, Key 3	179165-009
C4	Capacitor, .1 $\mu$ F, 50 V, $+80\%$ -20%, Cer.	122002-104			
C4M1-C4M5, C4MP	Capacitor, 47 pF, 100 V, $\pm 5\%$ , Ceramic	122016-470	M28M, M48M, M148M, M248M	Resistor, 10 $\Omega$ , $\pm 5\%$ , 1/8 W	110027-100
C5-C8	Capacitor, .01 $\mu$ F, 50 V, $+80\%$ -20%, Cer.	122002-103	MOH_0-MOH_7, MOL_0-MOL_7, PF0H, PF0L, PF0M, PF1H, PF1L, PF1M	Socket, 32 Pin, .600, Dbl Wipe	179356-0632
C7M1-C7M4, C7MA, C7MN	Capacitor, 47 pF, 100 V, $\pm 5\%$ , Ceramic	122016-470			
C9-C12	Capacitor, 1000 pF, 100 V, $\pm 10\%$ , Cer.	122015-102	PGM_LL	Socket, 32 Pin, .600, Dbl Wipe	179356-0632
C13-C15	Capacitor, 270PFC, 50 V, EMI Filter	140006-271	PGM_LM	Socket, 32 Pin, .600, Dbl Wipe	179356-0632
C16	Capacitor, 100 pF, 100 V, $\pm 5\%$ , Ceramic	122016-101	PGM_UM	Socket, 32 Pin, .600, Dbl Wipe	179356-0632
C17	Capacitor, .1 $\mu$ F, 50 V, $\pm 80\%$ -20%, Cer.	122002-104	PGM_UU	Socket, 32 Pin, .600, Dbl Wipe	179356-0632
C18	Capacitor, .01 $\mu$ F, 50 V, $\pm 80\%$ -20%, Cer.	122002-103			
C19	Capacitor, .1 $\mu$ F, 50 V, $\pm 80\%$ -20%, Cer.	122002-104	Q1-Q3	Transistor, 2N3904	133041-001
C20, C21	Capacitor, .01 $\mu$ F, 50 V, $\pm 80\%$ -20%, Cer.	122002-103	Q4, Q5	Transistor, 2N5306	133033-001
C22, C23	Capacitor, .1 $\mu$ F, 50 V, $\pm 80\%$ -20%, Cer.	122002-104	PF6B, PF56B, PFR4M		
C24-C31	Capacitor, .01 $\mu$ F, 50 V, $\pm 80\%$ -20%, Cer.	122002-103		Resistor, 10 $\Omega$ , $\pm 5\%$ , 1/8 W	110027-100
C32-C37	Capacitor, .1 $\mu$ F, 50 V, $\pm 80\%$ -20%, Cer.	122002-104	R1	Resistor, 470 $\Omega$ , $\pm 5\%$ , 1/8 W	110027-471
C38-C41	Capacitor, .01 $\mu$ F, 50 V, $\pm 80\%$ -20%, Cer.	122002-103	R2	Resistor, 75 $\Omega$ , $\pm 5\%$ , 1/8 W	110027-750
C42-C50	Capacitor, .1 $\mu$ F, 50 V, $\pm 80\%$ -20%, Cer.	122002-104	R3	Resistor, 470 $\Omega$ , $\pm 5\%$ , 1/8 W	110027-471
C51, C52	Capacitor, .01 $\mu$ F, 50 V, $\pm 80\%$ -20%, Cer.	122002-103	R4	Resistor, 10 $\Omega$ , $\pm 5\%$ , 1/8 W	110027-100
C53-C60	Capacitor, .1 $\mu$ F, 50 V, $\pm 80\%$ -20%, Cer.	122002-104	R4M1-R4M5, R4MP	Resistor, 47 $\Omega$ , $\pm 5\%$ , 1/8 W	110027-470
C61, C62	Capacitor, .01 $\mu$ F, 50 V, $\pm 80\%$ -20%, Cer.	122002-103	R5	Resistor, 100 $\Omega$ , $\pm 5\%$ , 1/8 W	110027-101
C63-C317, C319, C321, C323, C326, C328, C330, C332	Capacitor, .1 $\mu$ F, 50 V, $\pm 80\%$ -20%, Cer.	122002-104	R6	Resistor, 1 K $\Omega$ , $\pm 5\%$ , 1/8 W	110027-102
CMO0-7	Capacitor, 47 pF, 100 V, $\pm 5\%$ , Ceramic	122016-470	R7	Resistor, 2.4 K $\Omega$ , $\pm 5\%$ , 1/8 W	110027-242
CR1, CR2	Diode, 1N4001	131048-001	R7MA	Resistor, 47 $\Omega$ , $\pm 5\%$ , 1/8 W	110027-470
			R8	Resistor, 75 $\Omega$ , $\pm 5\%$ , 1/8 W	110027-750

## Primal Rage Game PCB Assembly, Continued

### Parts List

Designator	Description	Part No.	Designator	Description	Part No.
R9	Resistor, 10 $\Omega$ , $\pm 5\%$ , 1/8 W	110027-100	R153	Resistor, 2.2 K $\Omega$ , $\pm 5\%$ , 1/8 W	110027-222
R10	Resistor, 100 $\Omega$ , $\pm 5\%$ , 1/8 W	110027-101	R154	Resistor, 10 K $\Omega$ , $\pm 5\%$ , 1/8 W	110027-103
R11	Resistor, 1 K $\Omega$ , $\pm 5\%$ , 1/8 W	110027-102	R156-R158	Resistor, 100 $\Omega$ , $\pm 5\%$ , 1/8 W	110027-101
R12	Resistor, 2.4 K $\Omega$ , $\pm 5\%$ , 1/8 W	110027-242	R159	Resistor, 1 K $\Omega$ , $\pm 5\%$ , 1/8 W	110027-102
R13	Resistor, 75 $\Omega$ , $\pm 5\%$ , 1/8 W	110027-750	R160	Resistor, 10 $\Omega$ , $\pm 5\%$ , 1/8 W	110027-100
R14	Resistor, 10 $\Omega$ , $\pm 5\%$ , 1/8 W	110027-100	R161, R162	Resistor, 1 K $\Omega$ , $\pm 5\%$ , 1/8 W	110027-102
R15	Resistor, 100 $\Omega$ , $\pm 5\%$ , 1/8 W	110027-101	R163, R164	Resistor, 10 $\Omega$ , $\pm 5\%$ , 1/8 W	110027-100
R16	Resistor, 1 K $\Omega$ , $\pm 5\%$ , 1/8 W	110027-102	R167	Resistor, 510 $\Omega$ , $\pm 5\%$ , 1/8 W	110027-510
R17	Resistor, 2.4 K $\Omega$ , $\pm 5\%$ , 1/8 W	110027-242	R168	Resistor, 10 $\Omega$ , $\pm 5\%$ , 1/8 W	110027-100
R18	Resistor, 0 $\Omega$ , $\pm 5\%$ , 1/4 W	110005-001	R169	Resistor, 10 K $\Omega$ , $\pm 5\%$ , 1/8 W	110027-103
R19, R20	Resistor, 1 K $\Omega$ , $\pm 5\%$ , 1/8 W	110027-102	R170	Resistor, 11.0 K $\Omega$ , $\pm 1\%$ , 1/4 W	110034-1102
R20D	Resistor, 10 $\Omega$ , $\pm 5\%$ , 1/8 W	110027-100	R171	Resistor, 10.5 K $\Omega$ , $\pm 1\%$ , 1/4 W	110034-1052
R21	Resistor, 470 $\Omega$ , $\pm 5\%$ , 1/8 W	110027-471	R172	Resistor, 1 K $\Omega$ , $\pm 5\%$ , 1/8 W	110027-102
R22-R25	Resistor, 1 K $\Omega$ , $\pm 5\%$ , 1/8 W	110027-102	R173	Resistor, 39 K $\Omega$ , $\pm 5\%$ , 1/8 W	110027-393
R26, R27	Resistor, 470 $\Omega$ , $\pm 5\%$ , 1/8 W	110027-471	R174, R175	Resistor, 39.2 K $\Omega$ , $\pm 1\%$ , 1/4 W	110034-3922
R28-R35	Resistor, 1 K $\Omega$ , $\pm 5\%$ , 1/8 W	110027-102	R176	Resistor, 470 $\Omega$ , $\pm 5\%$ , 1/8 W	110027-471
R36-R45	Resistor, 470 $\Omega$ , $\pm 5\%$ , 1/8 W	110027-471	R178	Resistor, 47 $\Omega$ , $\pm 5\%$ , 1/8 W	110027-470
R46	Resistor, 1 K $\Omega$ , $\pm 5\%$ , 1/8 W	110027-102	R179, R180	Resistor, 10 K $\Omega$ , $\pm 5\%$ , 1/8 W	110027-103
R47	Resistor, 470 $\Omega$ , $\pm 5\%$ , 1/8 W	110027-471	R181	Resistor, 4.7 K $\Omega$ , $\pm 5\%$ , 1/8 W	110027-472
R48, R49	Resistor, 1 K $\Omega$ , $\pm 5\%$ , 1/8 W	110027-102	R184	Resistor, 10 K $\Omega$ , $\pm 5\%$ , 1/8 W	110027-103
R50-R57	Resistor, 470 $\Omega$ , $\pm 5\%$ , 1/8 W	110027-471	R186	Resistor, 1 K $\Omega$ , $\pm 5\%$ , 1/8 W	110027-102
R58-R68	Resistor, 1 K $\Omega$ , $\pm 5\%$ , 1/8 W	110027-102	R188	Resistor, 10 $\Omega$ , $\pm 5\%$ , 1/8 W	110027-100
R69	Resistor, 470 $\Omega$ , $\pm 5\%$ , 1/8 W	110027-471	R189	Resistor, 470 $\Omega$ , $\pm 5\%$ , 1/8 W	110027-471
R70-R77	Resistor, 10 K $\Omega$ , $\pm 5\%$ , 1/8 W	110027-103	R190	Resistor, 10 K $\Omega$ , $\pm 5\%$ , 1/8 W	110027-103
R78-R83	Resistor, 1 K $\Omega$ , $\pm 5\%$ , 1/8 W	110027-102	R191, R192	Resistor, 1 K $\Omega$ , $\pm 5\%$ , 1/8 W	110027-102
R84	Resistor, 4.7 K $\Omega$ , $\pm 5\%$ , 1/8 W	110027-472	R194	Resistor, 470 $\Omega$ , $\pm 5\%$ , 1/8 W	110027-471
R85-R97	Resistor, 1 K $\Omega$ , $\pm 5\%$ , 1/8 W	110027-102	R196	Resistor, 1 K $\Omega$ , $\pm 5\%$ , 1/8 W	110027-102
R98-R109	Resistor, 470 $\Omega$ , $\pm 5\%$ , 1/8 W	110027-471	R202	Resistor, 47 $\Omega$ , $\pm 5\%$ , 1/8 W	110027-470
R110-R123	Resistor, 10 $\Omega$ , $\pm 5\%$ , 1/8 W	110027-100	R204	Resistor, 4.7 K $\Omega$ , $\pm 5\%$ , 1/8 W	110027-472
R124	Resistor, 100 $\Omega$ , $\pm 5\%$ , 1/8 W	110027-101	R205	Resistor, 47 $\Omega$ , $\pm 5\%$ , 1/8 W	110027-470
R125	Resistor, 220 $\Omega$ , $\pm 5\%$ , 1/8 W	110027-221	R207, R208, R210, R211, R214, R217, R218	Resistor, 10 K $\Omega$ , $\pm 5\%$ , 1/8 W	110027-103
R126, R127	Resistor, 100 $\Omega$ , $\pm 5\%$ , 1/8 W	110027-101	RMO0-RMO7	Resistor, 47 $\Omega$ , $\pm 5\%$ , 1/8 W	110027-470
R128	Resistor, 10 K $\Omega$ , $\pm 5\%$ , 1/8 W	110027-103	RVGND	Resistor, 0 $\Omega$ , $\pm 5\%$ , 1/4 W	110005-001
R129, R130	Resistor, 10 $\Omega$ , $\pm 5\%$ , 1/8 W	110027-100	SW1	Switch, Slide, SPDT	160040-001
R131	Resistor, 1 K $\Omega$ , $\pm 5\%$ , 1/8 W	110027-102	VCRI	Connector, 2 Circuit, Header, .100 Ctr	179048-002
R133	Resistor, 470 $\Omega$ , $\pm 5\%$ , 1/8 W	110027-471	WDOK	LED, Red, T1-3/4, Diffused, .5MCD, 80-Deg	138021-001
R134	Resistor, 4.7 K $\Omega$ , $\pm 5\%$ , 1/8 W	110027-472	XIQ2	Resistor, 10 $\Omega$ , $\pm 5\%$ , 1/8 W	110027-100
R136	Resistor, 10 K $\Omega$ , $\pm 5\%$ , 1/8 W	110027-103			
R137, R138	Resistor, 220 $\Omega$ , $\pm 5\%$ , 1/8 W	110027-221			
R139-R146	Resistor, 10 $\Omega$ , $\pm 5\%$ , 1/8 W	110027-100			
R147, R148	Resistor, 47 $\Omega$ , $\pm 5\%$ , 1/8 W	110027-470			
R149, R152	Resistor, 1 K $\Omega$ , $\pm 5\%$ , 1/8 W	110027-102			

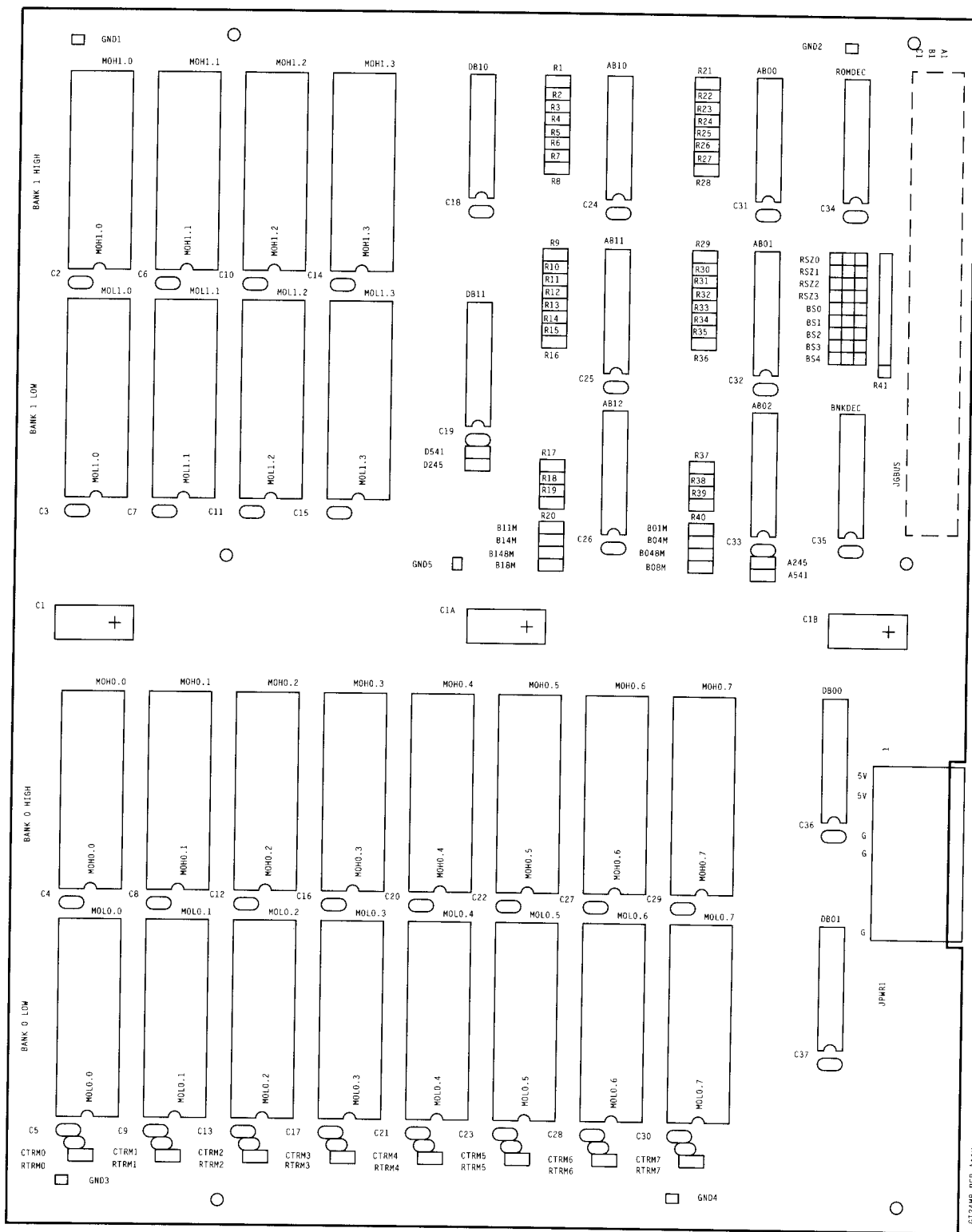

Figure 4-6 GT24M8 PCB Assembly

A053602-02 A

GT24M8 PCB ASSY.  
A053601-XX REV. A

## GT24M8 PCB Assembly Parts List

Designator	Description	Part No.	Designator	Description	Part No.
(HS1-HS3)	Screw, Pan, 4-40X3/8, X-Rec, Cad	172025-3206	B18M, B48M, B148M	Res, 10 $\Omega$ , $\pm 5\%$ , 1/8 W	110027-100
A	Pr, GAL16V8, 10NS, Romdec 50F8	136102-0260	BNKDEC	Socket, 20 Pin, .300, Dbl Wipe	179356-0320
A	Pr, GAL16V8, 15NS, Bnkdec 1FD0	136102-0261	BS1, BS2	Res, 10 $\Omega$ , $\pm 5\%$ , 1/8 W	110027-100
A	Pr, Mrom, 1MX8, 100NS, MOL0.2 5FC8	136102-0320	C1,C1A,C1B	Capacitor, 100 $\mu$ F, 16 V, Electrolytic, Axial	124008-107
A	Pr, Mrom, 1MX8, 100NS, MOL0.6 96C1	136102-0328	C2-C37	Capacitor, .1 $\mu$ F, 50 V, +80%-20%, Cer.	122002-104
A	Pr, Mrom, 1MX8, 100NS, MOL0.4 90BD	136102-0324	CTRM0-CTRM7	Capacitor, 47 pF, 100 V, $\pm 5\%$ , Cer.	122016-470
A	Pr, Mrom, 1MX8, 100NS, MOL1.0 9FB6	136102-0332	D245	Res, 10 $\Omega$ , $\pm 5\%$ , 1/8 W	110027-100
A	Pr, Mrom, 1MX8, 100NS, MOH1.2 40E9	136102-0337	DB0, DB1, DB10, DB11	Integrated Circuit, 74F245	137591-001
A	Pr, Mrom, 1MX8, 100NS, MOH0.7 F538	136102-0331	GND1-GND5	Test Point	179051-001
A	Pr, Mrom, 1MX8, 100NS, MOH0.1 89F0	136102-0319	JBS0, JBS3	Connector, 2 Ckt, Header, .100 Ctr	179048-002
A	Pr, Mrom, 1MX8, 100NS, MOL0.0 B69E	136102-0316	JPWR1	Connector, 9 Ckt, Header, .156, Key 3, Rt	179213-109
A	Pr, Mrom, 1MX8, 100NS, MOL0.7 82B5	136102-0330	JRSZ0	Connector, 2 Ckt, Header, .100 Ctr	179048-002
A	Pr, Mrom, 1MX8, 100NS, MOH0.5 9060	136102-0327	MOH0.0-MOH0.7, MOH1.0-MOH1.3, MOL0.0-MOL0.7, MOL1.0-MOL1.3	Socket, 32 Pin, .600, Dbl Wipe	179356-0632
A	Pr, Mrom, 1MX8, 100NS, MOL0.1 CF92	136102-0318	R1-R40	Resistor, 33 $\Omega$ , $\pm 5\%$ , 1/8 W	110027-330
A	Pr, Mrom, 1MX8, 100NS, MOH0.3 D5E7	136102-0323	R41	Resistor, 4.7 $\Omega$ Kx9, $\pm 2\%$ , 1/8 W	118010-472
A	Pr, Mrom, 1MX8, 100NS, MOL1.2 0777	136102-0336	ROMDEC	Socket, 20 Pin, .300, Dbl Wipe	179356-0320
A	Pr, Mrom, 1MX8, 100NS, MOH0.6 87C4	136102-0329	RSZ1-RSZ3	Res, 10 $\Omega$ , $\pm 5\%$ , 1/8 W	110027-100
A	Pr, Mrom, 1MX8, 100NS, MOL1.3 0E47	136102-0338	RTRM0-RTRM7	Res, 47 $\Omega$ , $\pm 5\%$ , 1/8 W	110027-470
A	Pr, Mrom, 1MX8, 100NS, MOL0.5 660E	136102-0326			
A	Pr, Mrom, 1MX8, 100NS, MOH0.0 9AB3	136102-0317			
A	Pr, Mrom, 1MX8, 100NS, MOH0.2 B2A6	136102-0321			
A	Pr, Mrom, 1MX8, 100NS, MOL0.3 D4DF	136102-0322			
A	Pr, Mrom, 1MX8, 100NS, MOH1.3 6AFB	136102-0339			
A	Pr, Mrom, 1MX8, 100NS, MOH1.1 E50C	136102-0335			
A	Pr, Mrom, 1MX8, 100NS, MOL1.1 BA48	136102-0334			
A	Pr, Mrom, 1MX8, 100NS, MOH1.0 1D6 A	136102-0333			
A	Pr, Mrom, 1MX8, 100NS, MOH0.4 F3EE	136102-0325			
A245	Res, 10 $\Omega$ , $\pm 5\%$ , 1/8 W	110027-100			
AB0-AB2, AB10-AB12	Integrated Circuit, 74F245	137591-001			
B1M, B4M	Res, 10K $\Omega$ , $\pm 5\%$ , 1/8 W	110027-103			
B8M	Res, 10 $\Omega$ , $\pm 5\%$ , 1/8 W	110027-100			
B11M, B14M	Res, 10K $\Omega$ , $\pm 5\%$ , 1/8 W	110027-103			

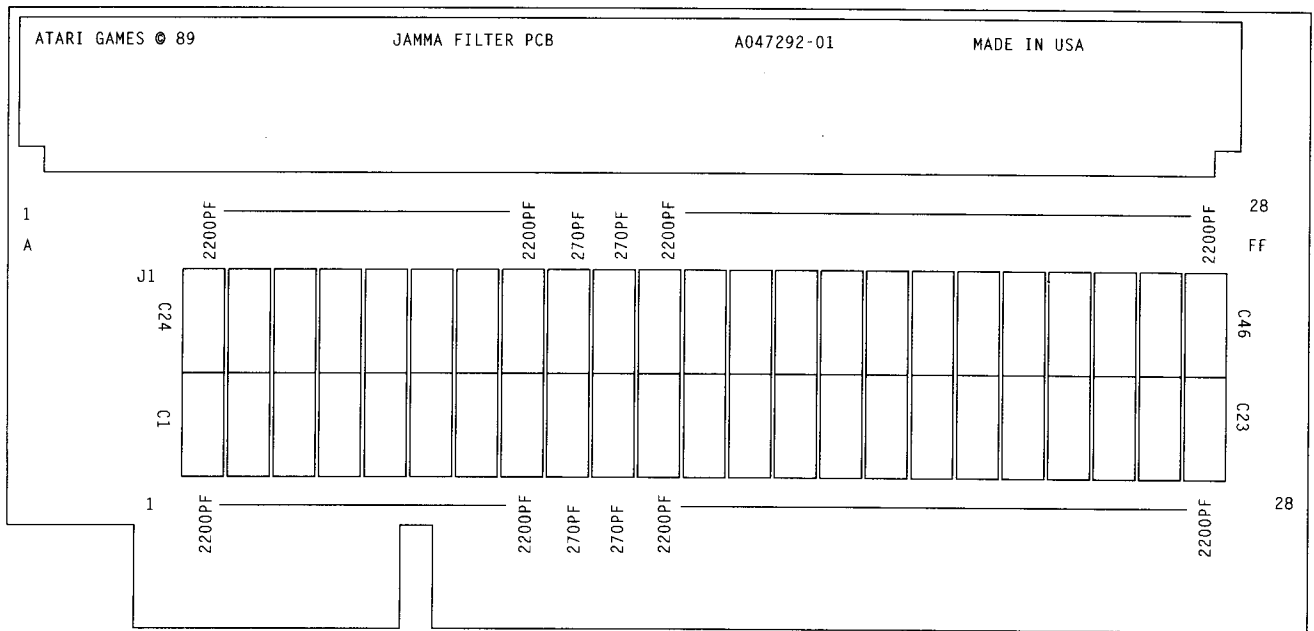

**Figure 4-7 JAMMA Filter PCB Assembly**

A047292-01 B

**JAMMA Filter PCB Assembly  
Parts List**

Designator	Description	Part No.	Designator	Description	Part No.
C1-8	2200 pF, 50V, 3-Pin EMI Filter Cap.	140006-222	C32, C33	270 pF, 50V, 3-Pin EMI Filter Cap.	140006-271
C9, C10	270 pF, 50V, 3-Pin EMI Filter Cap.	140006-271	C34-46	2200 pF, 50V, 3-Pin EMI Filter Cap.	140006-222
C11-31	2200 pF, 50V, 3-Pin EMI Filter Cap.	140006-222	J1	Connector, 56 Ckt., .156 Ctr, RT	179240-056

# Schematic Diagrams

## INTRODUCTION

**T**HIS CHAPTER contains the schematic diagrams for most of the Primal Rage™ game printed-circuit boards, including the game PCB (also called the GT board), the GT24M8 PCB, and the JAMMA Filter PCB. In addition, this chapter includes wiring diagrams for the entire game and the coin door, and a block diagram of the CH31 (CAGE Audio) PCB. The PCB *assembly drawings* are illustrated in Chapter 4, Parts Illustrations.

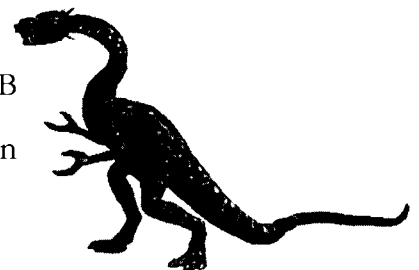



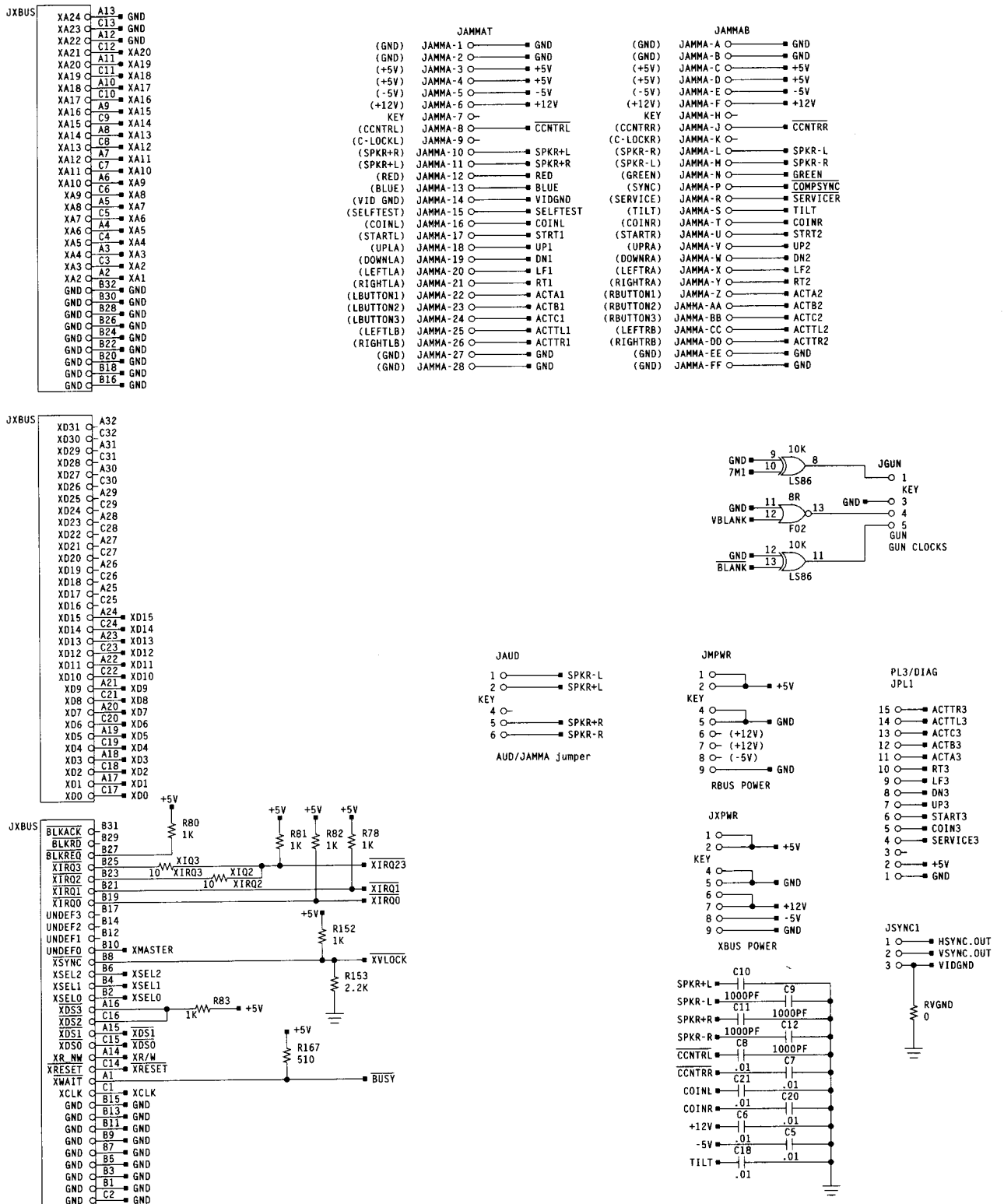
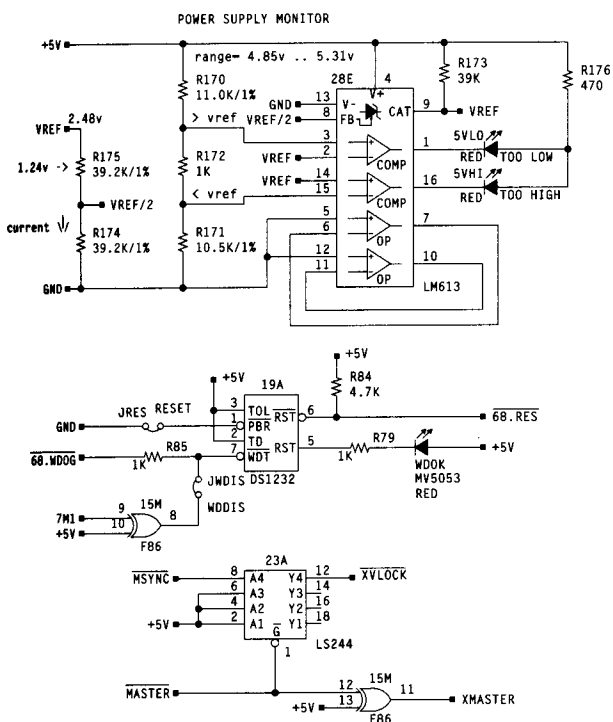
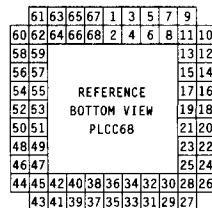
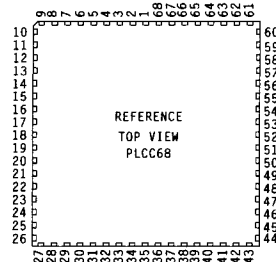
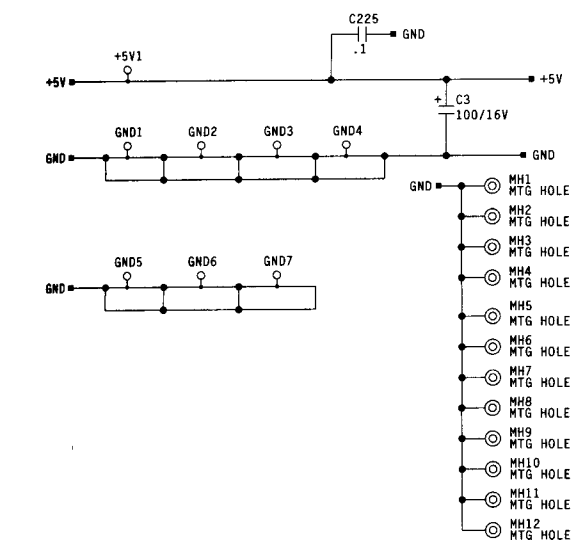

Figure 5-1 Primal Rage Game (GT) PCB Schematic Diagram

051511-01 Rev. D (Sheet 1)



SPARE GATES

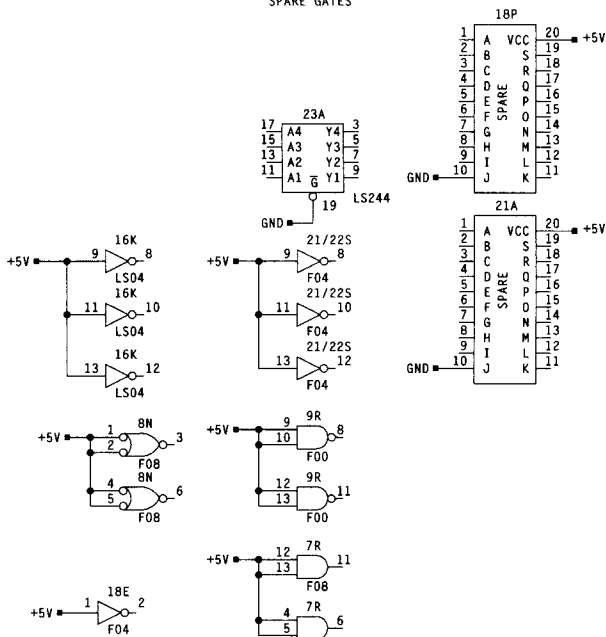

Figure 5-1 Primal Rage Game (GT) PCB Schematic Diagram, Continued

051511-01 Rev. D (Sheet 1)

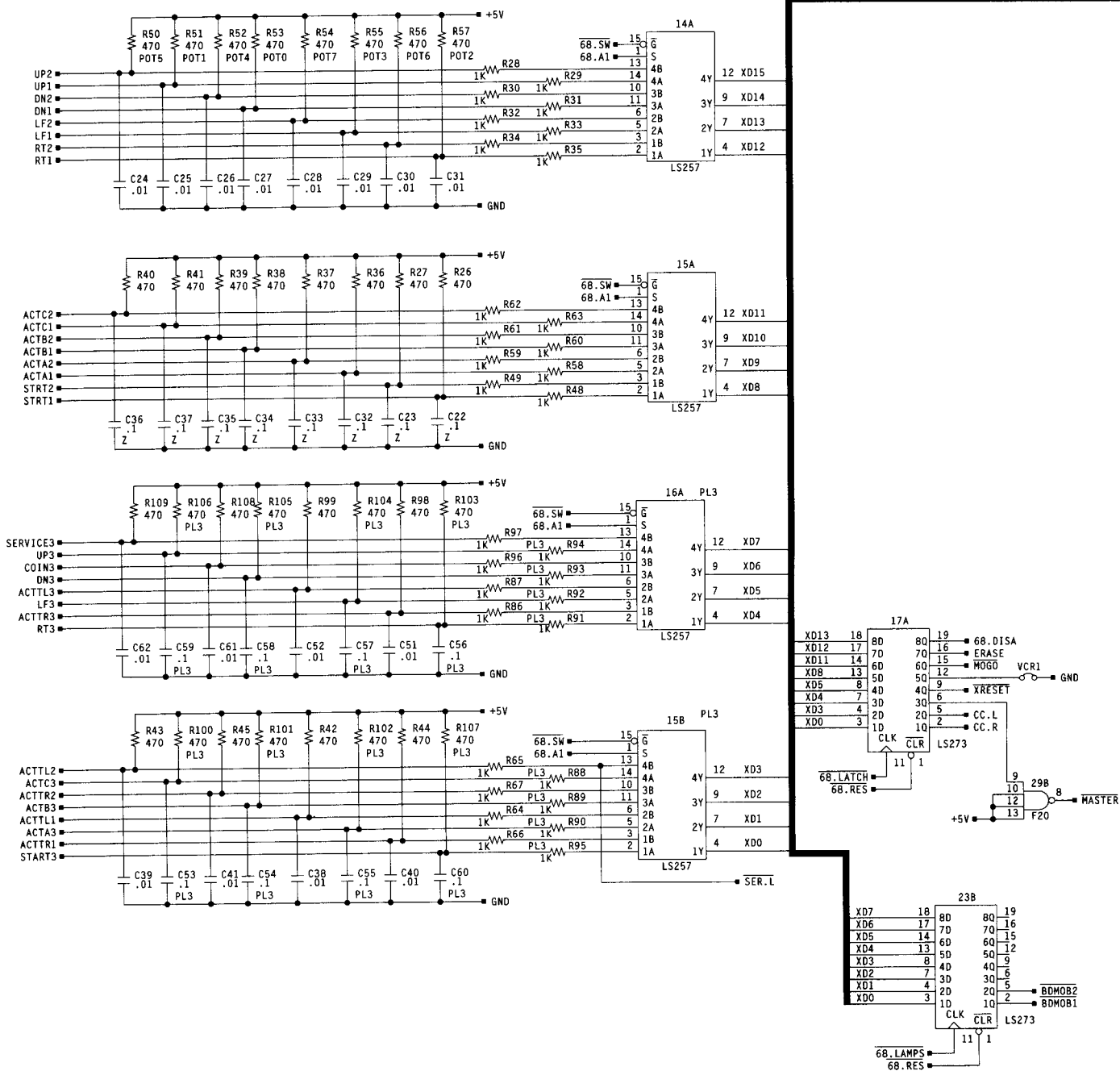

Figure 5-1 Primal Rage Game (GT) PCB Schematic Diagram

051511-01 Rev. D (Sheet 9)

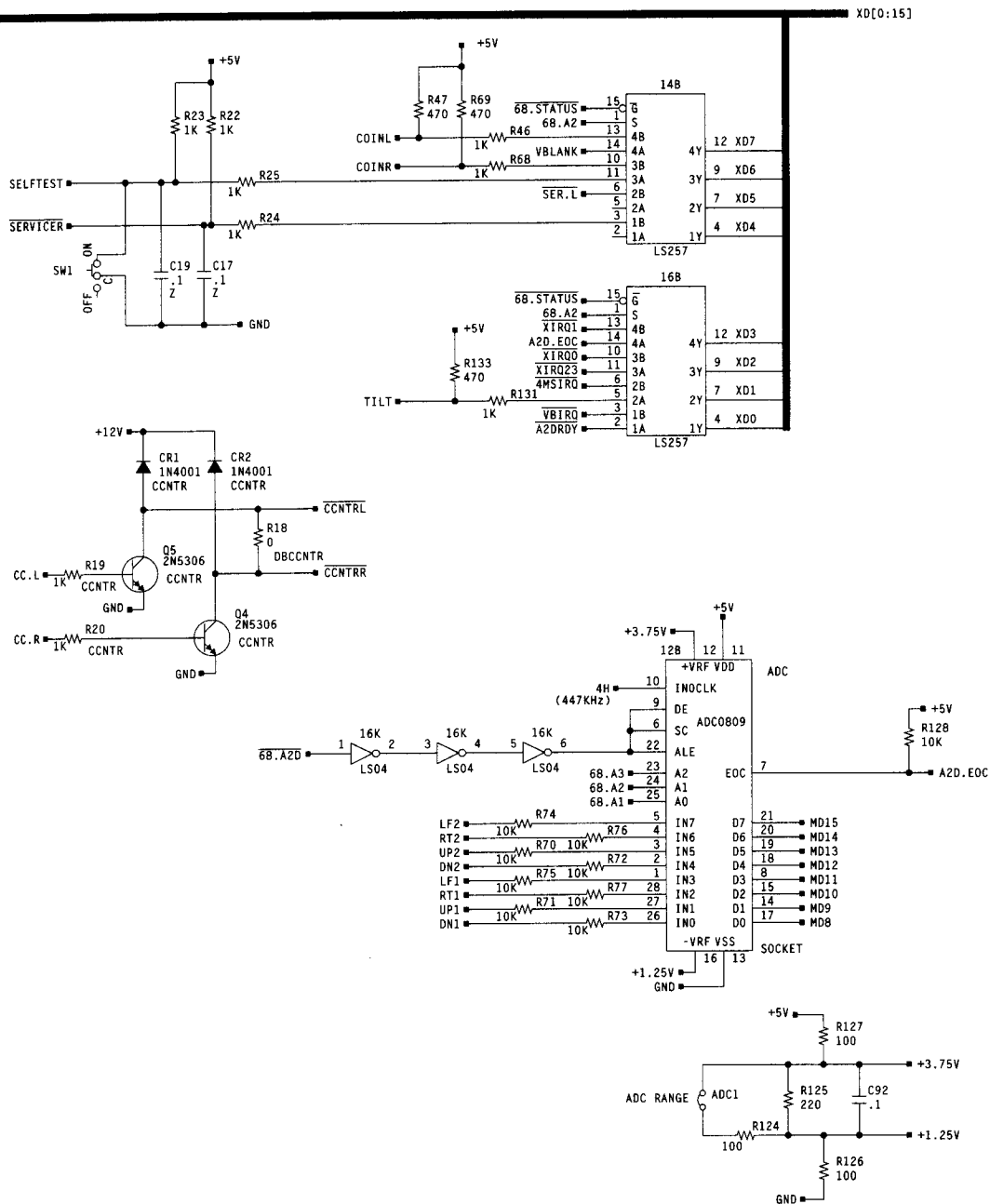

Figure 5-1 Primal Rage Game (GT) PCB Schematic Diagram, Continued

051511-01 Rev. D (Sheet 9)

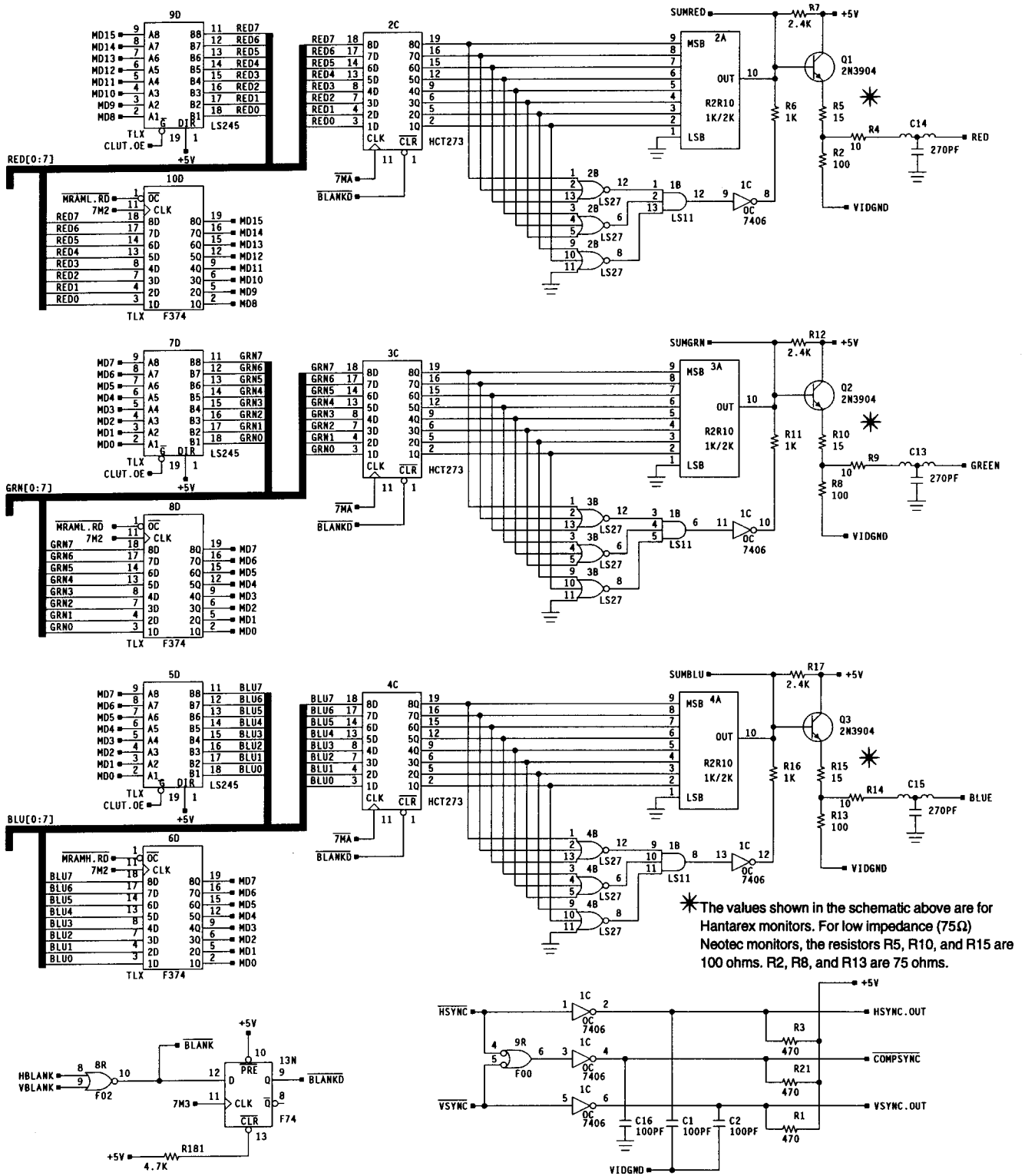
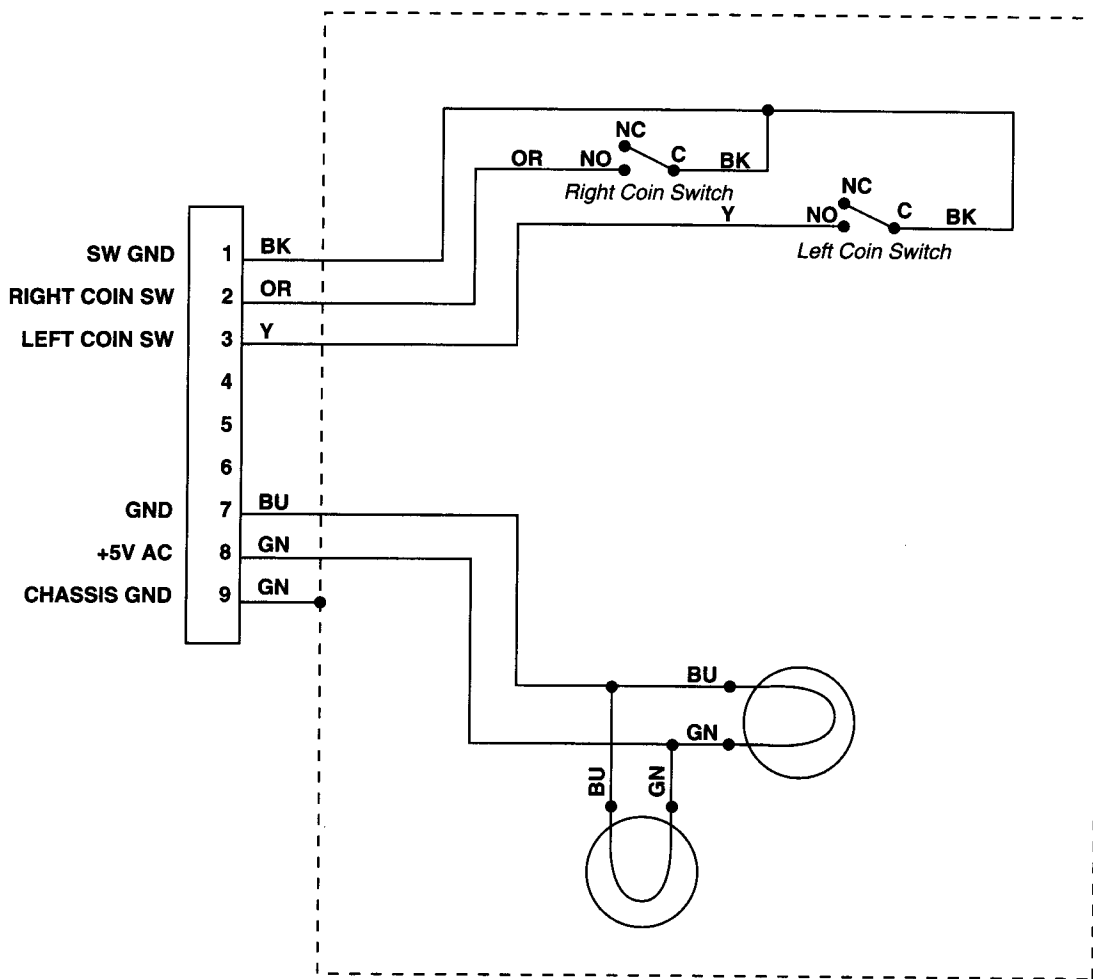

Figure 5-1 Primal Rage Game (GT) PCB Schematic Diagram

051511-01 Rev. D (Sheet 15)



**Figure 5-2 Coin Door Wiring Diagram**

049507-01 Rev. A

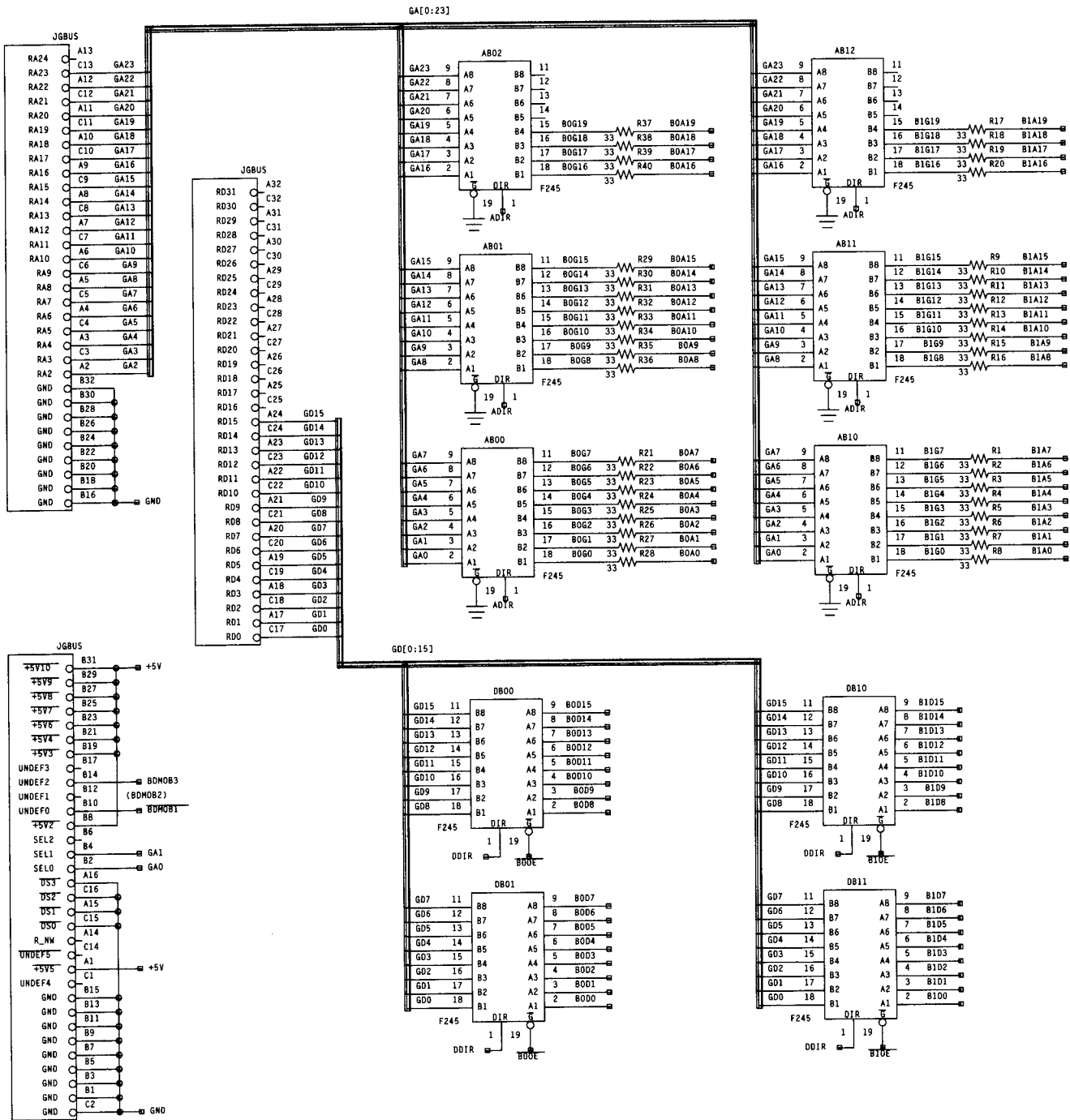

Figure 5-3 GT24M8 PCB Schematic Diagram

053601-xx Rev. B (Sheet 1)

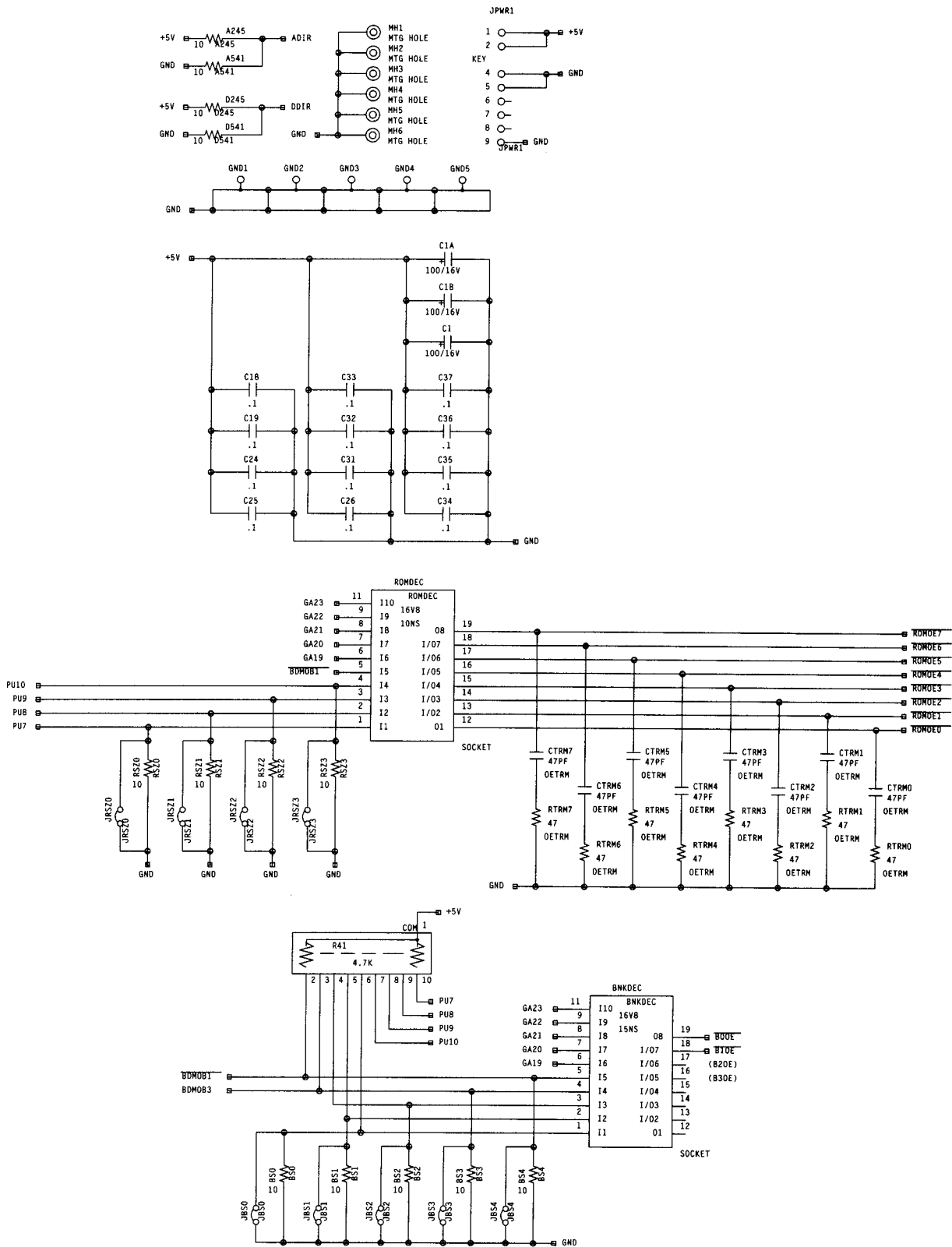

Figure 5-3 GT24M8 PCB Schematic Diagram, Continued

053601-xx Rev. B (Sheet 1)



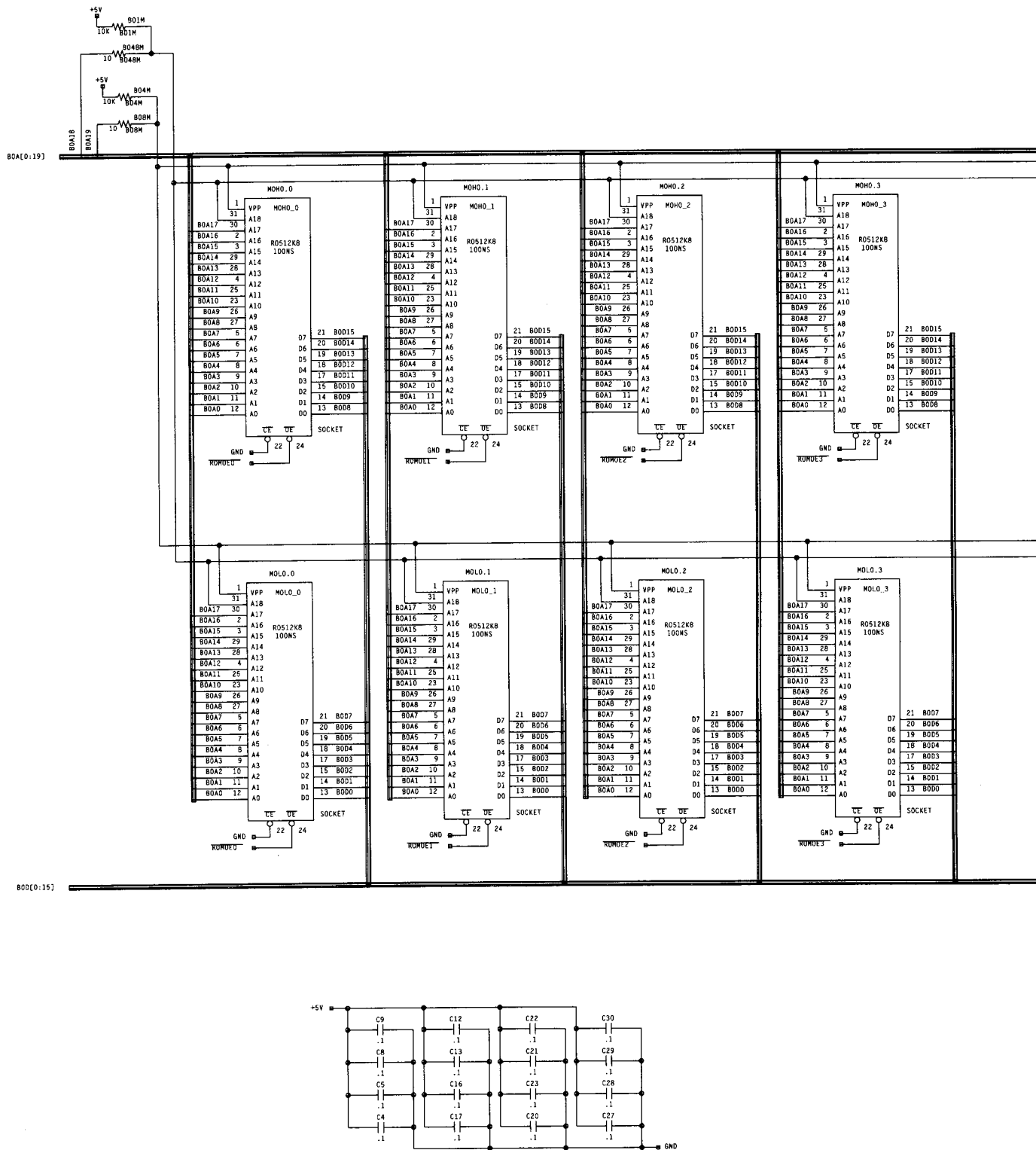

Figure 5-3 GT24M8 PCB Schematic Diagram

053601-xx Rev. B (Sheet 2)

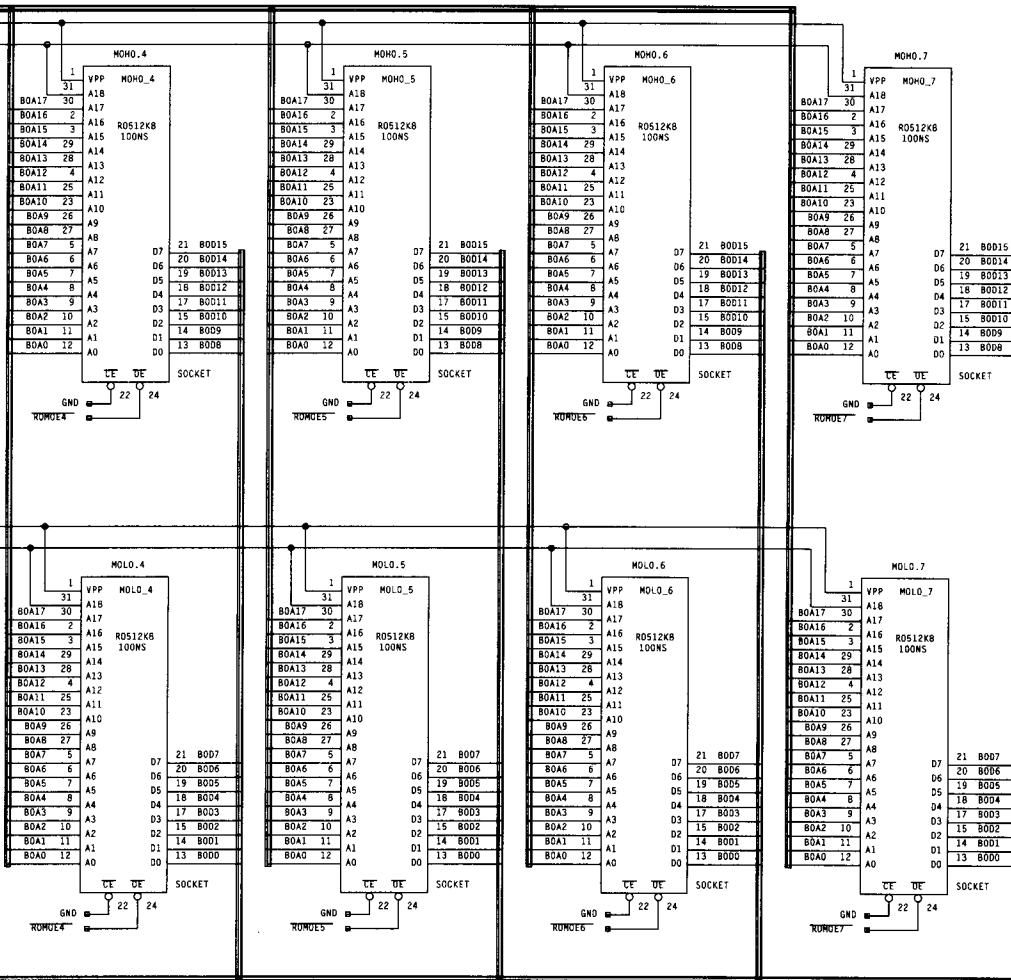

Figure 5-3 GT24M8 PCB Schematic Diagram, Continued

053601-xx Rev. B (Sheet 2)

FROM GAME BOARD

- 1 ○ GND
- 2 ○ GND
- 3 ○ J1+5V
- 4 ○ J1+5V
- 5 ○ J1-5V
- 6 ○ J1+12V
- 7 ○ KEY
- 8 ○ J1CNTR2
- 9 ○ J1LOCK2
- 10 ○ J1SPKR1-
- 11 ○ J1AUDGND
- 12 ○ J1GREEN
- 13 ○ J1SYNC
- 14 ○ J1SERV
- 15 ○ J1TILT
- 16 ○ J1RCOIN
- 17 ○ J1START2
- 18 ○ J1UP2A
- 19 ○ J1DOWN2A
- 20 ○ J1LEFT2A
- 21 ○ J1RT2A
- 22 ○ J1FIRE2
- 23 ○ J1UP2B
- 24 ○ J1DOWN2B
- 25 ○ J1LEFT2B
- 26 ○ J1RT2B
- 27 ○ GND
- 28 ○ GND
- A ○ GND
- B ○ GND
- C ○ J1+5V
- D ○ J1+5V
- E ○ J1-5V
- F ○ J1+12V
- H ○ KEY
- J ○ J1CNTR1
- K ○ J1LOCK1
- L ○ J1SPKR1+
- M ○ J1AUD+
- N ○ J1RED
- P ○ J1BLUE
- R ○ J1VIDGND
- S ○ J1SLFTST
- T ○ J1LCOIN
- U ○ J1START1
- V ○ J1UPIA
- W ○ J1DOWN1A
- X ○ J1LEFT1A
- Y ○ J1RT1A
- Z ○ J1FIRE1
- AA ○ J1UP1B
- BB ○ J1DOWN1B
- CC ○ J1LEFT1B
- DD ○ J1RT1B
- EE ○ GND
- FF ○ GND

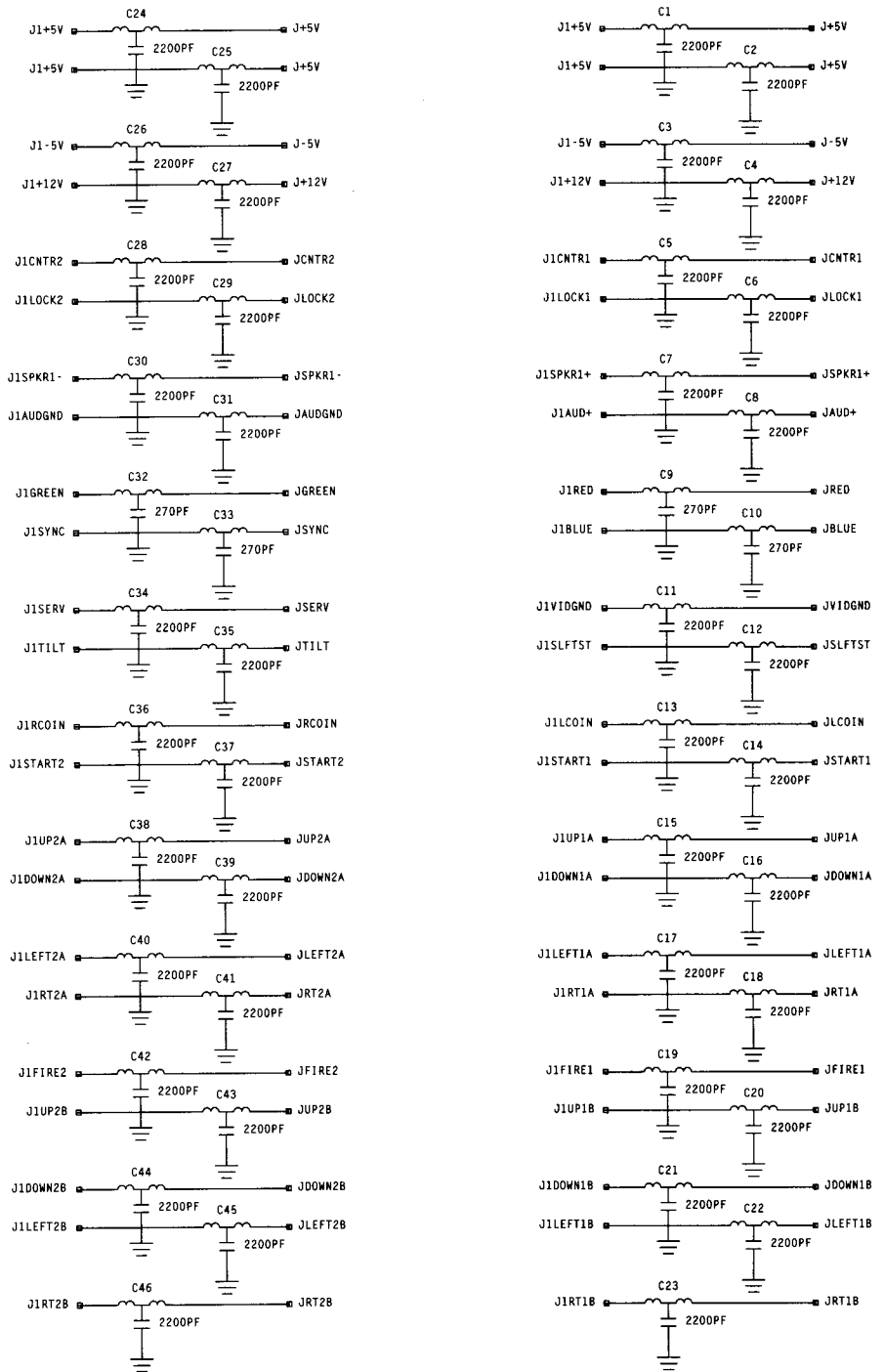
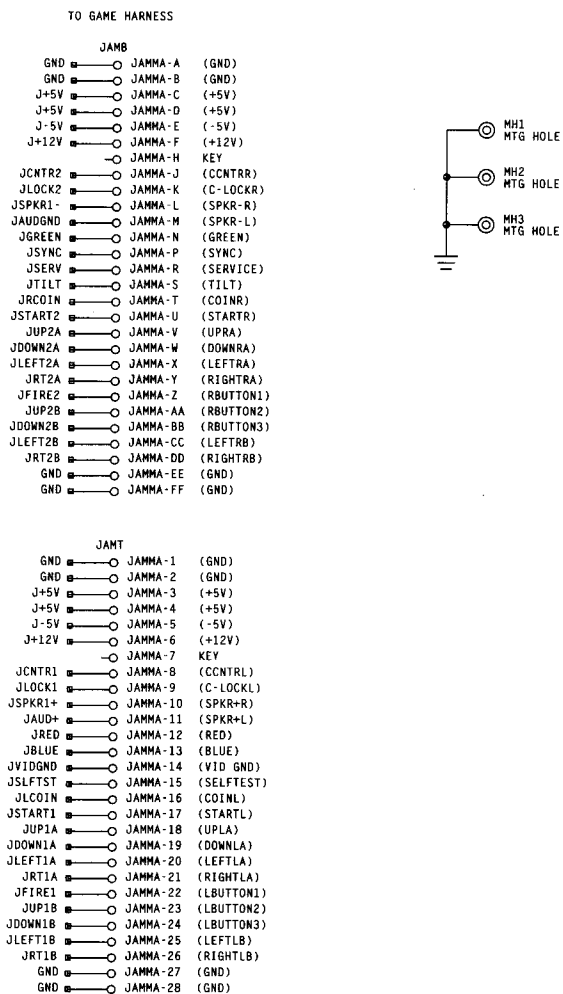

Figure 5-4 JAMMA Filter PCB Schematic Diagram

047292-01 B



**Figure 5-4 JAMMA Filter PCB Schematic Diagram**

047292-01 B

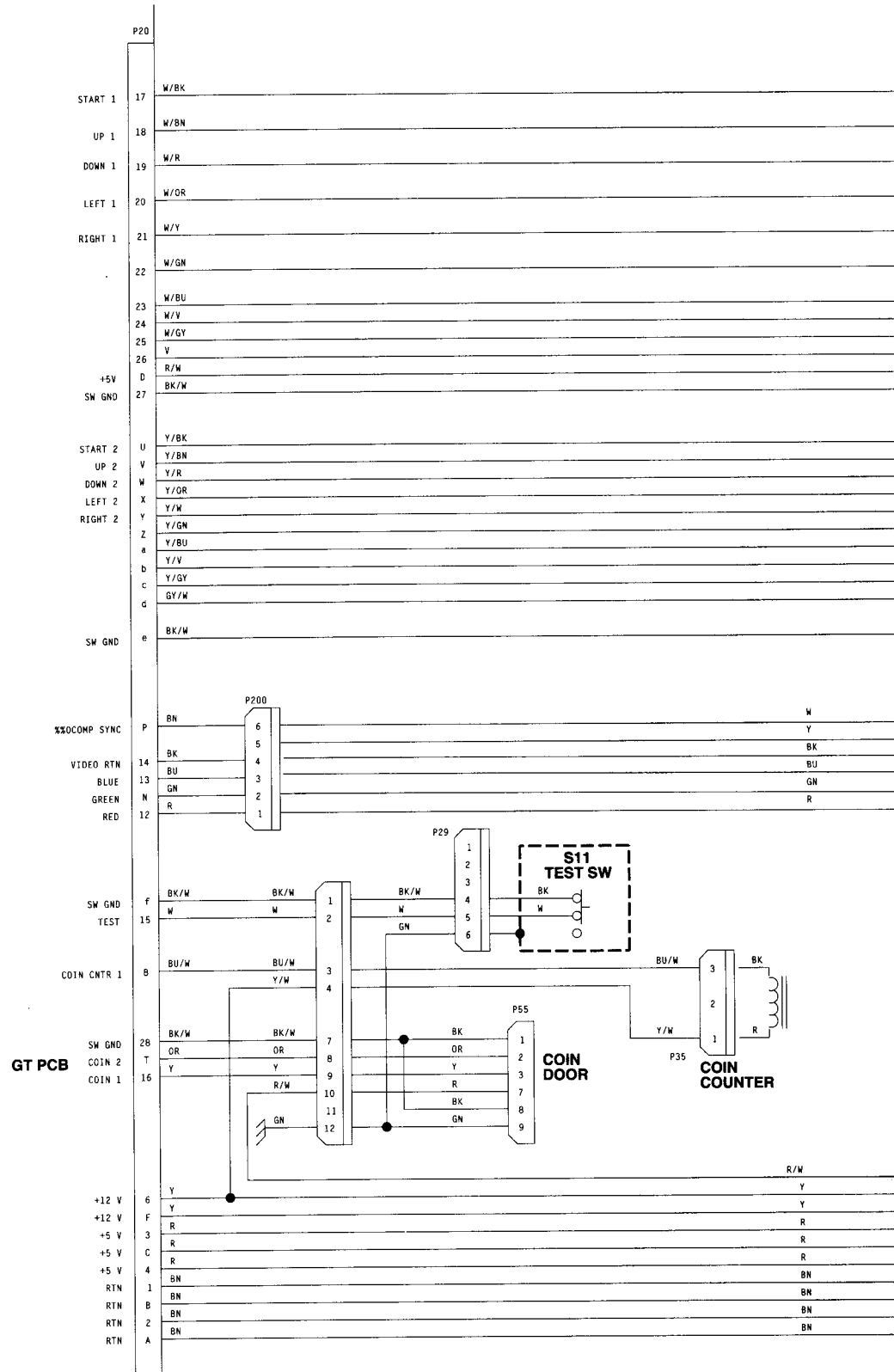

Figure 5-5 Primal Rage Game Wiring Diagram

053499-01 Rev. A

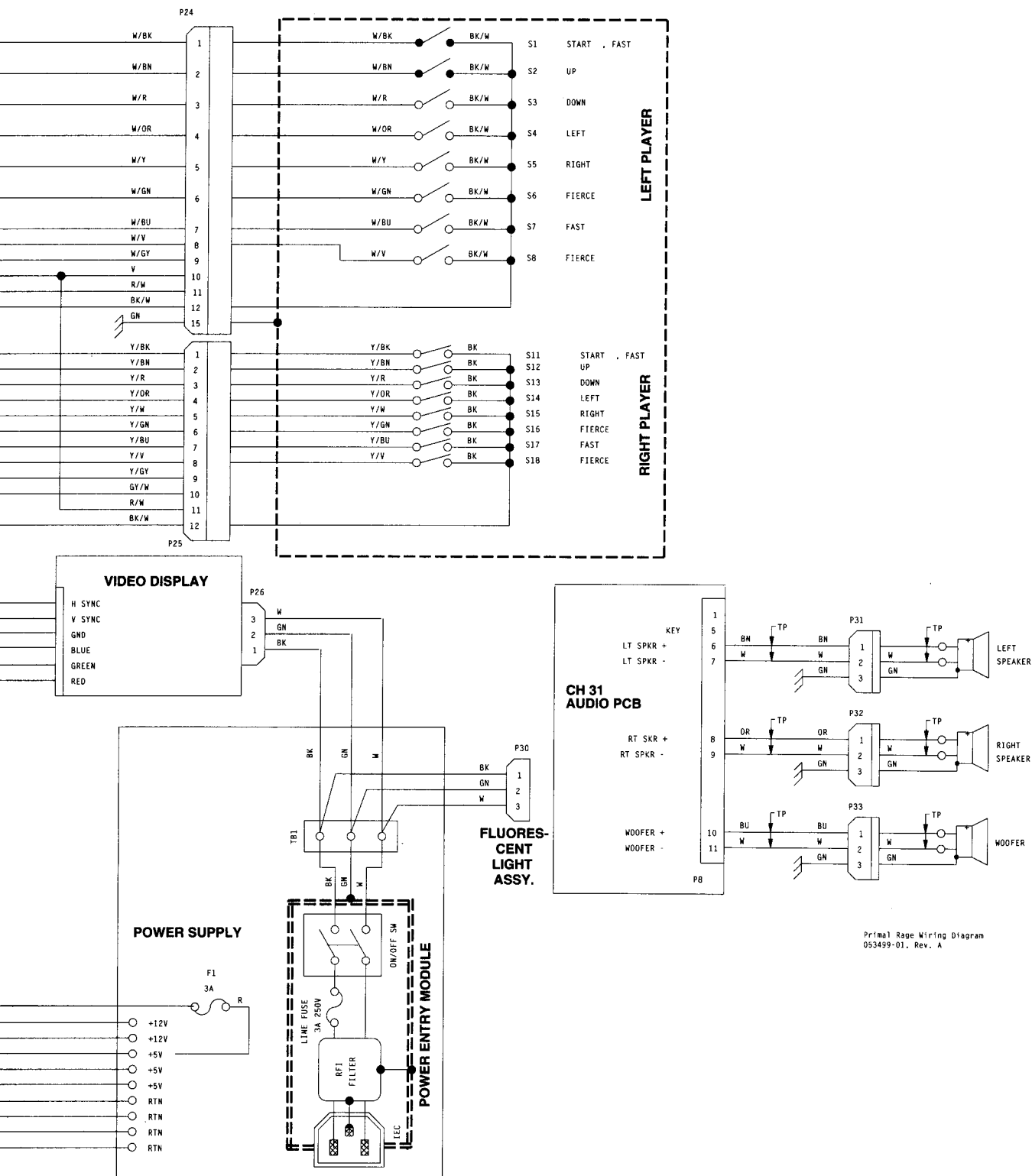
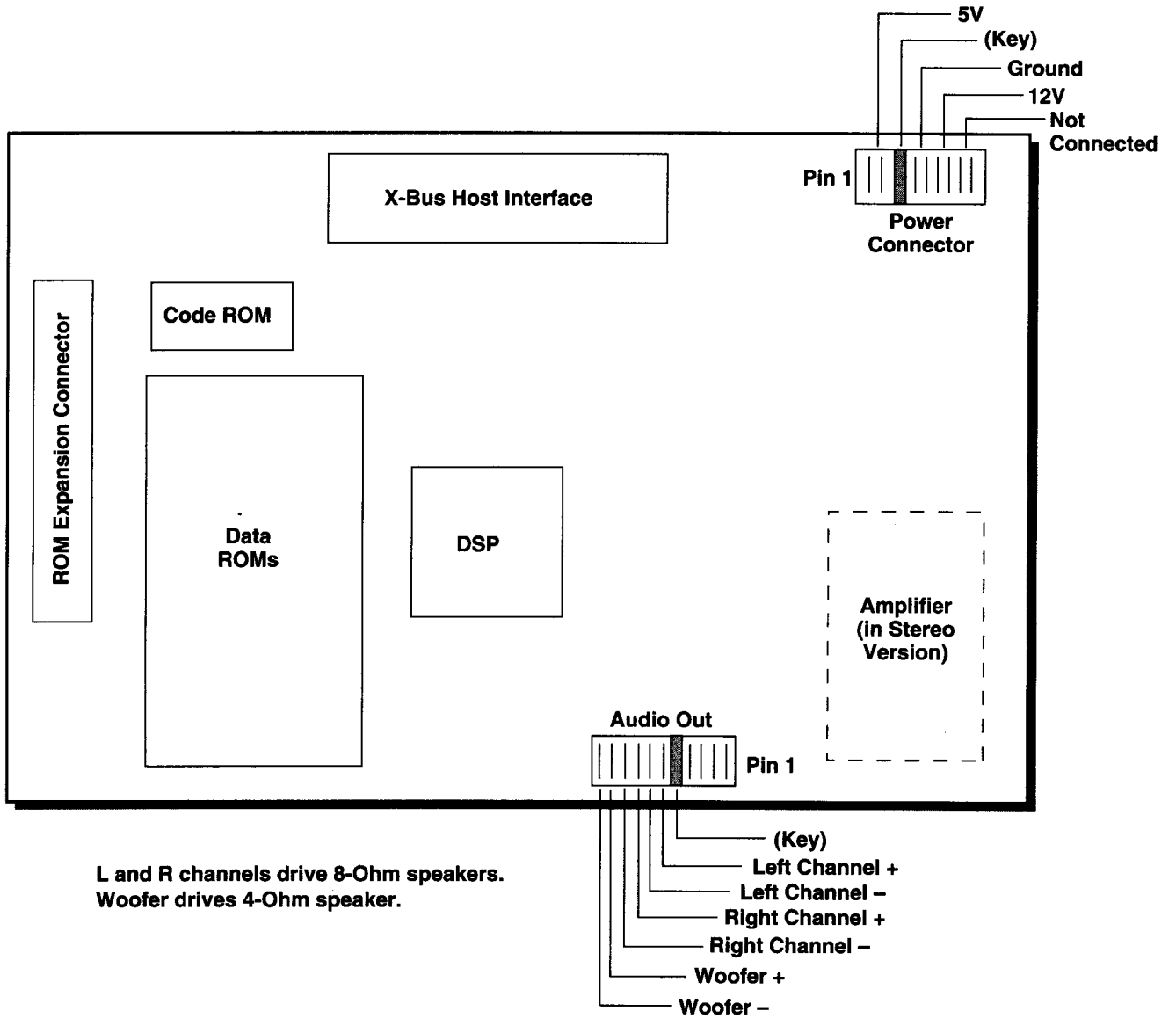

Figure 5-5 Primal Rage Game Wiring Diagram, Continued

053499-01 Rev. A



**Figure 5-6 CH31\_2 (CAGE Audio) Board Block Diagram**

# Warranty

Seller warrants that its printed-circuit boards and parts thereon are free from defects in material and workmanship under normal use and service for a period of ninety (90) days from date of shipment. Seller warrants that its video displays and laser-video disc players (in games supplied with displays and video-disc players) are free from defects in material and workmanship under normal use and service for a period of thirty (30) days from date of shipment. None of the Seller's other products or parts thereof are warranted.

If the products described in this manual fail to conform to this warranty, Seller's sole liability shall be, at its option, to repair, replace, or credit Buyer's account for such products which are returned to Seller during said warranty period, provided:

- (a) Seller is promptly notified in writing upon discovery by Buyer that said products are defective;
- (b) Such products are returned prepaid to Seller's plant; and
- (c) Seller's examination of said products discloses to Seller's satisfaction that such alleged defects existed and were not caused by accident, misuse, neglect, alteration, improper repair, installation, or improper testing.

In no event shall Seller be liable for loss of profits, loss of use, incidental or consequential damages.

*Except for any express warranty set forth in a written contract between Seller and Buyer which contract supersedes the terms herein, this warranty is expressed in lieu of all other warranties expressed or implied, including the implied warranties of merchantability and fitness for a particular purpose, and of all other obligations or liabilities on the Seller's part, and it neither assumes nor authorizes any other person to assume for the Seller any other liabilities in connection with the sale of products by Seller.*

The use of any non-Atari parts may void your warranty, according to the terms of the warranty. The use of any non-Atari parts may also adversely affect the safety of your game and cause injury to you and others. Be very cautious in using non-Atari-supplied components with our games, in order to ensure your safety.

Atari distributors are independent, being privately owned and operated. In their judgment they may sell parts or accessories other than Atari parts or accessories. Atari Games Corporation cannot be responsible for the quality, suitability or safety of any non-Atari part or any modification including labor which is performed by such distributor.



Featuring...

**CAGE**

TM M

Total Immersion Audio



TIME WARNER INTERACTIVE

675 Sycamore Drive  
Milpitas, CA 95035 U.S.A.

(Formerly known as Atari Games Corporation)