

© 1987 V-System Co., Ltd. under license to Bally Midway Mfg. Co.

Universal Field Kit Instruction Manual

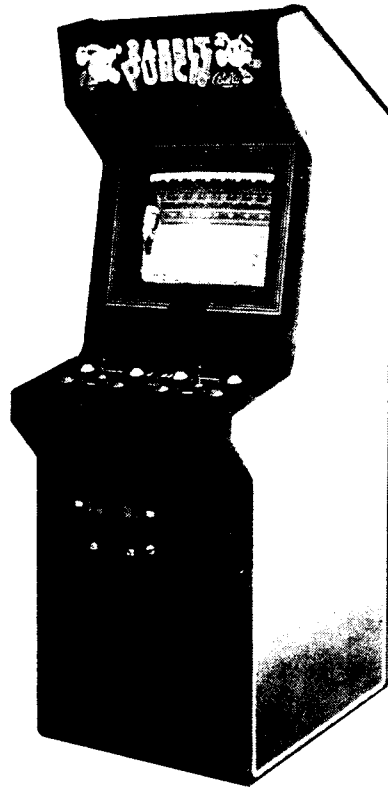

Bally
MIDWAY™

10601 W. Belmont Avenue
Franklin Park, Illinois 60131
U.S.A.

Phone: (312) 451-9200 Fax No.: 312-451-4150
Cable Address: MIDCO Telex No.: 72-1596

WARNING

THIS GAME MUST BE GROUNDED. FAILURE TO DO SO MAY RESULT IN DESTRUCTION TO ELECTRONIC COMPONENTS.

WARNING: This equipment generates, uses and can radiate radio frequency energy and if not installed and used in accordance with the instruction manual, may cause interference to radio communications. It has been tested and found to comply with the limits for a CLASS A computing device pursuant to SUBPART J of PART 15 of FCC RULES, which are designed to provide reasonable protection against such interference when operated in a commercial environment. Operation of this equipment in a residential area is likely to cause interference in which case the user at his own expense will be required to take whatever measures may be required to correct the interference.

ELECTRICAL BULLETIN: FOR ALL APPARATUS COVERED BY THE CANADIAN STANDARDS ASSOCIATION (CSA) STANDARD C22.2 NO. 1, WHICH EMPLOYS A SUPPLY CORD TERMINATED WITH A POLARIZED 2-PRONG ATTACHMENT PLUG

CAUTION: TO PREVENT ELECTRIC SHOCK DO NOT USE THIS (POLARIZED) PLUG WITH AN EXTENSION CORD, RECEPTACLE OR OTHER OUTLET UNLESS THE BLADES CAN BE FULLY INSERTED TO PREVENT BLADE EXPOSURE.

ATTENTION: POUR PREVENIR CHOCS ELECTRIQUES NE PAS UTILISER CETTE FICHE POLARISEE AVEC UN PROLONGATEUR UNE PRISE DE COURANT OU UNE AUTRE SORTIE DE COURANT, SAUF SI LES LAMES PEUVENT ETRE INSEREES A FOND SANS EN LAISSER AUCUNE PARTIE A DECOUVERT.

**USE ONLY GENUINE BALLY MIDWAY
APPROVED REPLACEMENT PARTS.**

©COPYRIGHT MCMLXXXVIII BY BALLY MIDWAY MFG CO ALL RIGHTS RESERVED.

NO PART OF THIS PUBLICATION MAY BE REPRODUCED BY ANY MECHANICAL, PHOTOGRAPHIC, OR ELECTRONIC PROCESS, OR IN THE FORM OF A PHONOGRAPHIC RECORDING, NOR MAY IT BE TRANSMITTED, OR OTHERWISE COPIED FOR PUBLIC OR PRIVATE USE, WITHOUT PERMISSION FROM THE PUBLISHER. THIS MANUAL IS FOR SERVICE USE ONLY, AND NOT FOR GENERAL DISTRIBUTION. FOR PERMISSION REQUESTS, WRITE: BALLY MIDWAY MFG. CO., 10601 W. BELMONT AVE., FRANKLIN PARK, IL 60131.

Printed in U.S.A.

RABBIT PUNCH UNIVERSAL FIELD CONVERSION KIT

TABLE OF CONTENTS

SYSTEM INFORMATION	PAGE
SAFETY	ii
WARNING	iv
KIT INSTRUCTIONS	1
GAME PLAY INSTRUCTIONS	2
CONVERSION PROCEDURE	4
GAME ADJUSTMENTS	10
LOGIC BOARD ASSEMBLY REFERENCE ILLUSTRATION	10
OPTION SWITCH SETTINGS	11
SELF-TEST PROCEDURE	14

ILLUSTRATED PARTS BREAKDOWN (IPB)

FIELD KIT ASSEMBLED - FRONT CABINET VIEW ILLUSTRATION	16
FIELD KIT ASSEMBLED - REAR CABINET CLOSE-UP VIEW ILLUSTRATION	17
FIELD KIT ILLUSTRATION (COMPONENT PARTS)	18
FIELD KIT PARTS LIST	19
CONTROL PANEL - FRONT VIEW ILLUSTRATION	20
CONTROL PANEL - REAR VIEW ILLUSTRATION	21
JOYSTICK ILLUSTRATION	22

ELECTRICAL INFORMATION

WIRING CHART	23
PRINTED CIRCUIT BOARD SCHEMATIC - TOP LOGIC BOARD (VS7-0102)	25
PRINTED CIRCUIT BOARD SCHEMATIC - BOTTOM LOGIC BOARD (VS7-0101) ..	28

LIST OF ILLUSTRATIONS

FIGURE 1. LOGIC BOARD ASSEMBLY REFERENCE	10
FIGURE 2. FIELD KIT ASSEMBLED - FRONT CABINET VIEW	16
FIGURE 3. FIELD KIT ASSEMBLED - REAR CABINET CLOSE-UP VIEW	17
FIGURE 4. FIELD KIT COMPONENT PARTS	18
FIGURE 5. CONTROL PANEL ASSEMBLY - FRONT VIEW	20
FIGURE 6. CONTROL PANEL ASSEMBLY - REAR VIEW	21
FIGURE 7. JOYSTICK ASSEMBLY	22

SAFETY

The following safety hints apply to all game Operators and Service Technicians. Specific warnings and caution are included in this Field Conversion Kit's instructions and procedures. Before proceeding with any instructions and procedures, ensure that you have read the warnings and cautions where they are applicable.

WARNINGS

AC POWER CONNECTION: Before connecting the game to the AC power source, ensure that the proper voltage selection plug is installed on the Electronic Chassis Assembly. Also, ensure that the game is plugged into a grounded 3-wire outlet.

PROPERLY GROUND THE GAME: To prevent an electrostatic discharge (ESD) shock to the Player, Operator or Technician, this game must be properly grounded. This includes attaching a ground connection to the Joystick mounting brackets or the Control Panel Assembly.

Before locking the game up or after installation and servicing the game, ensure that all ground connections to the game and control panel are secure.

DISCONNECT POWER BEFORE SERVICING OR REPAIRING THE GAME:

To avoid electrical shock, disconnect the game from the AC power source before removing or repairing any portion of the game. When repairing or replacing the monitor, extra precautions must be taken to avoid an electrical shock because high voltages may exist within the monitor circuitry and cathode ray tube (CRT) even after power has been disconnected from the game.

DO NOT touch the monitor or printed circuit boards on the monitor (CRT) chassis with your hands or metal objects! Always discharge the second anode from the monitor before servicing the monitor or printed circuit boards. To discharge the monitor, attach one end of a large, well insulated, 20kV jumper to ground. Next, momentarily touch the free end of the jumper to the anode by sliding it under the anode cap. Wait two minutes and discharge the anode again.

USE THE PROPER FUSE(S): To avoid electrical shock, use the replacement fuse that is specified in the Parts List for this game. The replacement fuse(s) must match the original fuse(s) replaced in fuse type, voltage rating and current rating.

HANDLING FLUORESCENT TUBE AND MONITOR (CRT) WITH CARE: When the fluorescent tube or monitor is dropped and breaks, it may implode! Shattered glass can fly eight (8) feet or more from the implosion. NEVER hold the monitor by the neck. It is advisable that safety glasses be worn when replacing or servicing the monitor on the service bench.

CAUTION

PROPERLY ATTACH ALL CONNECTORS: Ensure that the connectors on each printed circuit board are properly connected. If the connector does not slip on easily, DO NOT force them. A reversed connector may damage your game and void the Warranty. All connectors are keyed to fit specific pins on each board. If the connector key is missing, refer to the wiring chart or electrical diagram, locate pin #1 and the wire color that corresponds to pin #1 before connecting the connector to the printed circuit board.

W A R N I N G

The parts contained in this Field Conversion Kit must be installed without deviation according to the instructions and procedures contained in the Manual and Kit. Failure to follow the instructions and procedures in every detail, may result in the creation of illegal interference to radio and TV reception.

BALLY-MIDWAY has verified that this Field Conversion Kit, when installed in the game(s) specified in this Manual, complies with the requirements in Part 15, Sub-Part J, of the FCC Rules for a Class A computing device. Operation of this equipment in a residential area may cause unacceptable interference to radio and TV reception, requiring the Operator to take whatever steps are necessary to correct the interference.

BALLY-MIDWAY will not be responsible for incomplete or improper conversions, or installation in a game for which this Field Conversion Kit is not intended. If this Field Conversion Kit is installed in a game that is not specified in this Manual or in a previously converted game, the Operator is required to take whatever steps are necessary to ensure compliance with the requirements in Part 15, Sub-Part J, of the FCC Rules for a Class A computing device.

S P E C I A L N O T E S

THE PARTS REMOVED, WHILE MAKING MODIFICATIONS EXPLAINED IN THIS MANUAL, WILL NOT BE RE-USED IN FUTURE GAME CONVERSION KITS.

The word "discard", as used in this Manual, makes reference to this fact. All parts removed may be considered usable for other purposes.

Please be advised that when converting a game, it is advisable that **all former Trademark and Copyright registrations** be removed during the conversion process.

KIT INSTRUCTIONS

The Rabbit Punch Field Conversion Kit does not contain a Power Supply Assembly. It is the responsibility of the purchaser to provide the Power Supply Assembly for this Kit that meets the following power supply specifications.

POWER SUPPLY SPECIFICATIONS

1. +5VDC @ 4.0 AMPS.
2. +12VDC @ 1.0 AMPS.

TOTAL POWER CAPABILITY

1. 35 WATTS (APPROXIMATELY). This is inclusive of the Power Supply specifications.

All of the above measurements are considered a close approximation that must be considered as the **absolute minimum**.

GAME PLAY INSTRUCTIONS

- > TWO PLAYERS CAN PLAY TOGETHER. THE OTHER PLAYER CAN BUY IN AT ANY TIME.

- > USE THE JOYSTICK TO CONTROL RABBIT MOVEMENT.

- > USE TOP BUTTONS TO SHOOT MISSILES.

- > USE BOTTOM BUTTONS TO FIRE OR PUNCH.

- > GET THE CANNED CARROTS AND EARN THE FOLLOWING:
 - A. EXTRA MISSLES
 - B. EXTRA ENERGY
 - C. EXTRA BONUS

CONVERSION PROCEDURE

The new RABBIT PUNCH Field Conversion Kit is designed to be installed in any upright model game cabinet with a horizontally mounted monitor. Please read all of the following instructions before installing this Field Conversion Kit.

Before you begin the conversion procedure, refer to Figure 2 - FIELD KIT COMPONENT PARTS ILLUSTRATION on page 18. Also, refer to the FIELD KIT PARTS LIST on page 19 to ensure that you have received all of the parts. If any parts are missing, other than the common hardware types, contact the Bally-Midway Service Parts Department.

TOOLS REQUIRED:

Standard or Metric Drill Bit Set	Solder
Hammer	Soldering Iron
Nut Driver Set	Utility Blade (Heavy Duty)
Power Drill	Wire Cutter
Punch	

REMOVAL OF THE EXISTING GAME HARDWARE:

1. Turn power OFF and disconnect the game from the wall outlet on the game that is to be converted.
2. After opening the rear access door(s) of the game and perform the following steps.

Step A - Disconnect all cabling and wiring from the existing P.C. (Printed Circuit) boards.

NOTE: This DOES NOT include internal wiring within the existing Monitor Assembly, High Voltage Cabling directly connecting the existing game cabinet ON/OFF switch, and the existing Header Light Assembly to the existing Power Supply Assembly or Power Chassis Assembly.

Step B - Remove all existing P.C. boards and their mounting hardware. Not included are P.C. boards within the Monitor Assembly and the Power Supply Assembly or Power Chassis Assembly. Discard the P.C. boards and their mounting hardware.

Step C - Remove and discard ground straps which provide earth ground to the P.C. boards that were removed. Also, discard the ground straps mounting hardware.

3. DO NOT REMOVE the existing Speaker Cable Assembly.

If the game's Speaker Cable Assembly is part of the existing Master Cable (Wire Harness) Assembly, do not disconnect these cable wires from the existing speaker(s).

Separate out the entire length of these cable wires from the Master Cable Assembly and then cut the wires off at their connections to the P.C. board connector of the existing Master Cable Assembly. Strip 1/4" (6.35mm) of insulation from each wire for later splicing and soldering.

If the cabinet's Speaker wiring is a separate Cable Assembly, do not disconnect the cable wires from the existing Speaker. Cut the wires off at their connections to the P.C. board connector. Strip 1/4" (6.35mm) of insulation from each wire for later splicing and soldering.

4. Before removing the existing Master Cable (Wire Harness) Assembly, locate the P.C. board connectors that are secured to the Main P.C. board on the existing Monitor Assembly. Locate the connectors on the Master Cable Assembly that are secured to the connectors on the existing Control Panel Cable Assembly.

NOTE: It is recommended that the connector housings be removed from the connectors and saved for possible later re-use. See INSTALLATION OF THE NEW GAME HARDWARE, Step E on page 6, Step 3.B. and Step 4.E on page 8.

5. For Master Cable wires that are soldered to locations on the Coin Door, it is recommended that you cut those wires approximately 12" (304.8mm) from the Coin Door and strip back their insulation for later splicing and soldering to the new Master Cable Assembly.
6. Remove and discard the existing Master Cable Assembly. Save the cable clamps and their mounting hardware for later re-use.
7. After disconnecting the ground strap from the existing Control Panel, remove the Control Panel from the game cabinet. Remove all controls and wiring from the Control Shelf. At this point you may want to remove the cable connector housing(s) from the connectors for later re-use. Discard the controls and the wiring and leave existing unused cable clamps in the same position for later re-use.
8. Remove the existing Attract Art Header and save it for later sizing of the new Plexi-Glass Header (supplied in the Kit).

INSTALLATION OF NEW GAME HARDWARE:

Before installing the New Game Hardware see the following items.

- o Figure 1 on page 15.
- o Figures 2 thru 6 on pages 16 thru 18 & pages 20 thru 22.
- o Wiring chart on page 23.

1. To install the new parts on the existing Control Panel, perform the following steps.

Step A - Trim the new Control Shelf Overlay (supplied in the Kit), which measures 23-7/8" (606.425mm) X 20" (508mm), so that

it properly covers the surface, or existing Overlay, on the Control Shelf. Ensure that the surface of the Control Shelf, to which the new Control Shelf Overlay is applied, is clean and free of all dirt, grease and grime. Slowly and carefully peel the heavy waxed backing paper from the new Control Shelf Overlay, exposing its permanent pressure-sensitive adhesive backing. Place the new Overlay over the surface, or the old Overlay on the Control Shelf.

- Step B - Cut out, or drill, new holes in the Control Shelf for the mounting of new controls. Ensure that the new hole locations do not conflict with the old control hole locations. **Carefully**, use the new Overlay as the drill template.
- Step C - Assemble the Control Shelf to the game cabinet.
- Step D - Install the new controls, supplied in the Kit, to the newly modified Control Shelf as shown in Figure 1 on page 20 and Figure 2 on page 21.
- Step E - At this point, there is an "option" to create a new Control Panel Cable Assembly, using your own wires with terminals to plug into the existing Control Panel Cable connectors housing(s) that you saved earlier, as shown in Figure 6 on page 21. Re-use the existing cable clamps to properly route the cable.

The other "option" is to (later on in the process) solder the bare wire ends of the new Master Cable Assembly to locations on the Control Shelf. For additional information, refer to the Wiring Chart on page 23.

IMPORTANT NOTES:

- ~ The Activator in each Joystick Assembly is positioned for "8-Way" joystick steering movement. For additional information, see Figure 6-JOYSTICK ILLUSTRATION on page 22.
 - ~ Ensure that when the Joystick of either assembly is pulled in any diagonal (45°) direction, BOTH switches affected MUST BE CLOSED AT THE SAME TIME. "Reaching the diagonals" on both Joysticks is CRITICAL TO PROPER GAME PLAY. Necessary switch adjustment requires bending switch leafs so that the switch contacts are properly closed when the Joystick is moved in any direction.
2. Install the RABBIT PUNCH Logic Board Assembly and the RADIO FREQUENCY SHIELD, supplied in the Kit, at the location inside the cabinet as suggested in Figure 3 - FIELD KIT ASSEMBLED - REAR CABINET CLOSE-UP VIEW ILLUSTRATION on page 17. Perform the following procedure.
 - A. The Radio Frequency Shield is supplied in the Kit as a flat piece of foil laminated heavy duty paper. Lay the Shield on a flat

surface, foil side down. All "crease lines" (except for one) are located on the opposite side of the foil side.

"Fold-up" the Shield along the "crease lines". The Shield will take the shape of a rectangular box. Position the "corner flap" as shown in Figure 3 on page 17, and staple the "corner flap" twice. The flat lid of the box does not have holes as does the shaped portion. The flat lid is the bottom of the Shield. Locate the last remaining "crease line" on the foil side of the flat lid, and fold it down. This becomes the "end folded flap" as shown in Figure 3 on page 17.

- B. Locate the 6" (152.4mm) rectangular "punch-out" area on the narrow side of the shaped, or top, portion of the Radio Frequency Shield. Remove the "punch-out" area along the perforated portion. This area will provide an opening for the Master Cable Assembly when the Shield is closed, as shown in Figure 3 on page 17.
- C. Referring to Figure 1 - LOGIC BOARD REFERENCE DRAWING on page 10 and the OPTION SWITCH SETTINGS on page 11 & 12, ensure that the DIP Switches DSW1 and DSW2 are set to the Factory Recommended Settings.
- D. The Logic Board Assembly has four (4) "stand-on" plastic feet that have mounting holes in them. The Shield lid has four (4) locating holes in it for mounting the Logic Board Assembly, by its four (4) plastic "stand-ons", to the non-foil side of the Shield lid and the right inside game cabinet wall (as you face the rear of the game cabinet) using the four (4) #8 wood screws (supplied in the Kit) as shown in Figure 3 on page 17.

This locating and positioning is recommended so that when the Radio Frequency Shield is opened, there is easy access to the DIP Switches and game volume controls located on the Logic Board Assembly.

- E. As shown in Figure 3 on page 17, the Radio Frequency Shield is sealed shut by inserting the "end flap" into the "folded end flap" which are both secured to the game cabinet wall using three (3) #8 wood screws (supplied in the Kit).

IMPORTANT NOTES:

- ~ DO NOT SECURE A GROUND STRAP TO THE INSTALLED LOGIC BOARD ASSEMBLY.
- ~ When securing the Master Cable Assembly 56-pin connector to the edge connector of the Logic Board Assembly, refer to the following.

Note that neither of the connectors are "keyed". Referring to Figure 1 on page 15, the number "1" appears at the left end of the edge connector on the component side of the Logic Board Assembly. On the solder side of the Logic Board, letters are used as pin numbers. For additional information, see the Wiring Chart on page 23.

To avoid incorrect or reversed connectors, remember that the four (4) red wires (connectors 3, 4, C & D) are located near the left end of the edge connector on the Logic Board Assembly.

3. Before installing the new Master Cable Assembly, perform the following steps.

Step A - Strip off 1/4" (6.35mm) of insulation from each of the bare wire ends (except for those wires that will not be used).

Step B - Ensure that the 6-pin KK156 connector housing, the 3-pin KK156 connector housing, and the ten (10) terminals (supplied in the Kit) are compatible with the Main P.C. Board on the Monitor. If they are compatible, use the parts to prepare the Video Cable portion of the Master Cable Assembly; if not, obtain the correct terminals and re-use the connector housing(s) that were saved earlier to prepare the Video Cable portion of the Master Cable Assembly. For additional information, see the Wiring Chart on page 23.

Step C - If you have made a new Control Panel Cable Assembly by re-using the cable connector housing(s) that were saved earlier, re-use the corresponding cable connector housing(s) for the Master Cable Assembly wires that go to the Control Panel.

4. To install the new Master Cable Assembly, perform the following procedures. For additional information, see Figure 3 on page 17 and the Wiring Chart on page 20.

A. Route the 5' (127.00mm) new Master Cable Assembly in the game to the Speaker(s), Monitor, Coin Door, Control Panel and Power Supply (or Power Chassis). Re-use the existing cable clamps.

B. Referring to the Wiring Chart on page 20, solder and splice dressed bare wire ends of the Master Cable Assembly to the Speaker wires and to the wiring from the Coin Door. If there is no wiring from the Coin Door, solder the dressed bare wire ends of the Master Cable Assembly to the Coin Door locations. One ground wire must be connected to the Coin Door.

C. Referring to the Wiring Chart on page 20, secure one +12VDC, one +5VDC and one ground from the Master Cable Assembly to the existing Power Supply Assembly (or Power Chassis Assembly).

D. Secure the P.C. board connector(s) of the Video Cable portion of the Master Cable Assembly to the Main P.C. board connector(s) on the Monitor Assembly.

E. If you are re-using the existing cable connectors for the Master Cable Assembly wiring to the Control Panel, join the connectors together. If not, solder the dressed bare wire ends directly to the Control Panel Assembly locations. Refer to the Wiring Chart to locate where the wires are to be soldered. Ensure that one (1)

ground wire from the Master Cable Assembly is routed to the Control Panel.

NOTE: The existing Control Panel ground strap must be connected to one of the new Joystick Assemblies as shown in Figure 6 - CONTROL PANEL - REAR VIEW ILLUSTRATION on page 21.

5. Install the new Plexi-Glass Header as described in the following procedure.
 - A. Center the existing Attract Header on the new over-sized Plexi-Glass Header that measures 10-1/2" (269.24mm) X 23-7/8" (606.425mm).
 - B. Draw a line around the outside edges of the existing Attract Header.
 - C. Use the utility blade to "score" and cut out a properly sized Plexi-Glass Header. Trim, if necessary, for an accurate fit.
 - D. Discard the old Attract Header.
 - E. Install the new Plexi-Glass Header in the game cabinet.
6. Close and latch the Control Panel.
7. Close and lock the Coin Door.
8. Before turning on the power to the game, leave the rear access door(s) off. If the game has an interlock switch, pull it out to its fully extended position.
9. Plug the game line cord into a properly ground wall outlet and turn the power on. Check the games operation on the Monitor screen and check the new controls for proper operation.

IMPORTANT NOTES:

- ~ If, for any reason, the game's Monitor screen displays Self-Test Mode information after power is turned on, operating the Test Switch alone will not restore the Game Mode. The game must be powered off, first. Next, move the Test Switch from the Test Mode to the Game Mode. When the power is turned back on, the game will power up in the Game Mode. For additional information, see the SELF-TEST PROCEDURE on page 14.
 - ~ If the Monitor screen is "inverted" when power is turned on, see the OPTION SWITCH SETTINGS information on page 12. By moving DIP switch #8 of DIP switch DSW2 (on the Logic Board Assembly) from OFF to ON, the Monitor screen display will rotate 180° to the normal position for viewing.
10. Close and lock the rear access door(s) (after returning the interlock switch, if the game has one, to its normal position.

GAME ADJUSTMENTS

VOLUME CONTROL VARIABLE RESISTORS/OPTION SWITCH SETTINGS

There are two (2) Volume Control variable resistors located, along with two (2) Option DIP (Dual-In-Line Package) switches on the Logic Board Assembly. To locate the resistors and DIP switches, see FIGURE 1 - LOGIC BOARD ASSEMBLY REFERENCE ILLUSTRATION.

Variable resistor VR2 controls the volume of the "background sound level" and variable resistor VR3 controls the volume of the "voice level".

To increase the volume of the sounds and voice, turn the appropriate variable resistor counter-clockwise (to the left). To decrease the volume of the sounds and voice, turn the appropriate variable resistor clockwise (to the right).

NOTE: When changing game Options, always perform the Self-Test Procedure described on pages 14 & 15 and play the game to ensure that the Options selected are correct.

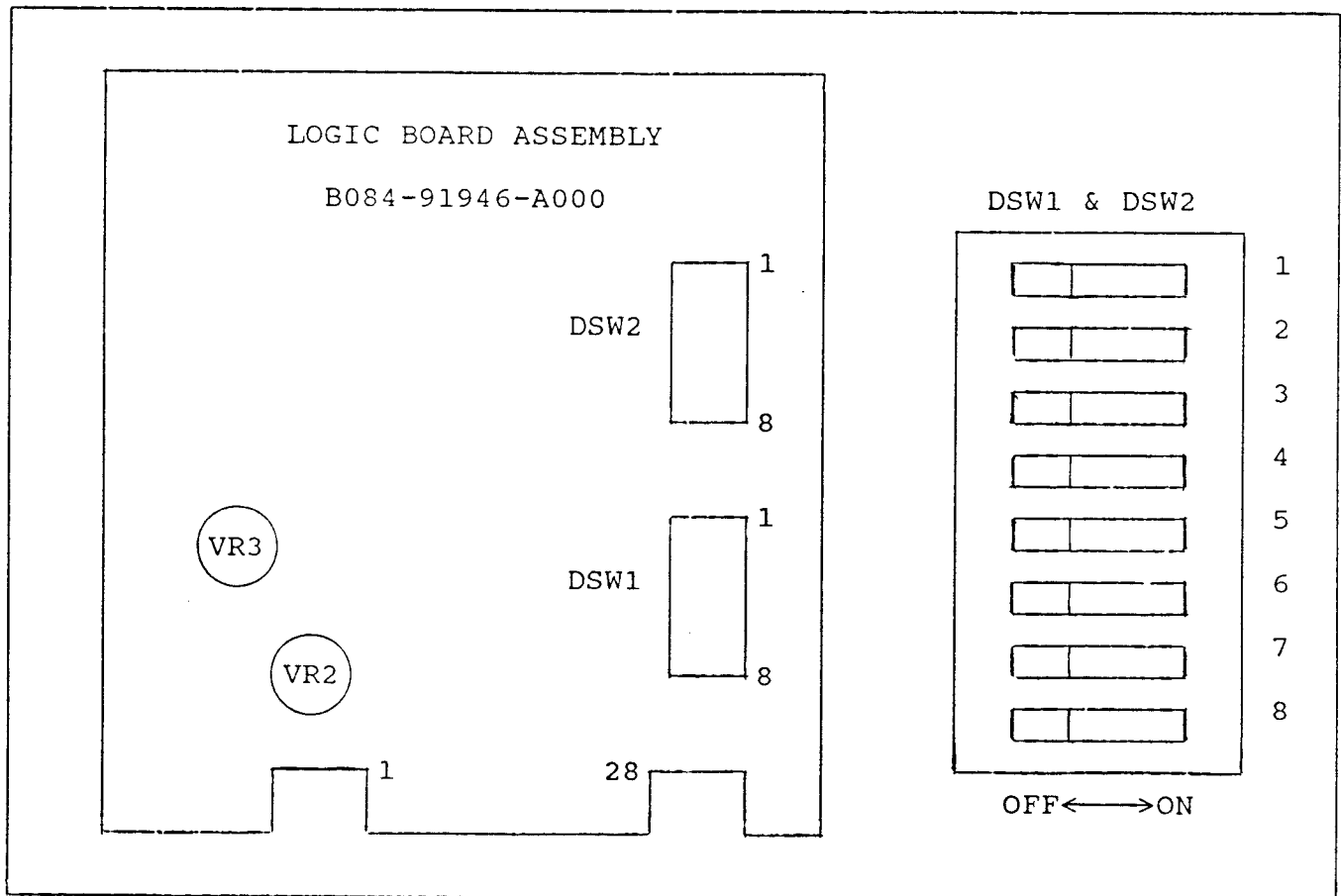

FIGURE 1 - LOGIC BOARD ASSEMBLY REFERENCE ILLUSTRATION

OPTION SWITCH SETTINGS

DIP SWITCH #1

COINS - CREDITS	COIN 1				COIN 2			
	1	2	3	4	5	6	7	8
1 COIN 1 CREDIT	OFF	OFF	OFF	OFF	OFF	OFF	OFF	OFF
1 COIN 2 CREDITS	OFF	OFF	OFF	O N	OFF	OFF	OFF	O N
1 COIN 3 CREDITS	O N	OFF	OFF	O N	O N	OFF	OFF	O N
1 COIN 4 CREDITS	OFF	O N	OFF	O N	OFF	O N	OFF	O N
1 COIN 5 CREDITS	O N	O N	OFF	O N	O N	O N	OFF	O N
1 COIN 6 CREDITS	OFF	OFF	O N	OFF	OFF	OFF	O N	OFF
2 COINS 1 CREDIT	OFF	OFF	O N	O N	OFF	OFF	O N	O N
3 COINS 1 CREDIT	O N	OFF	O N	O N	O N	OFF	O N	O N
4 COINS 1 CREDIT	OFF	O N	O N	O N	OFF	O N	O N	O N
2 COINS 3 CREDITS	OFF	O N	O N	OFF	OFF	O N	O N	OFF
2 COINS 1 CREDIT	O N	OFF	O N	OFF	O N	OFF	O N	OFF
4 COINS 2 CREDITS								
5 COINS 3 CREDITS								
6 COINS 4 CREDITS								
1 COIN 1 CREDIT	O N	O N	OFF	OFF	O N	O N	OFF	OFF
2 COINS 2 CREDITS								
3 COINS 3 CREDITS								
4 COINS 4 CREDITS								
5 COINS 6 CREDITS								
1 COIN 1 CREDIT	OFF	O N	OFF	OFF	OFF	O N	OFF	OFF
2 COINS 2 CREDITS								
3 COINS 3 CREDITS								
4 COINS 5 CREDITS								
1 COIN 1 CREDIT	O N	OFF	OFF	OFF	O N	OFF	OFF	OFF
2 COINS 3 CREDITS								

NOTES:

1. FACTORY SETTING: ALL SLIDE SWITCHES SET IN THE OFF POSITION.
2. THE DUAL-IN-LINE PACKAGE (DIP) SWITCHES "DSW2" IS LOCATED ON THE LOGIC BOARD ASSEMBLY AS SHOWN IN FIGURE 1 ON PAGE 10.

OPTION SWITCH SETTINGS

DIP SWITCH #2

O P T I O N		1	2	3	4	5	6	7	8
GAME DIFFICULTY	NORMAL	OFF	OFF						
	EASY	OFF	O N						
	HARD	O N	OFF						
	HARDEST	O N	O N						
NUMBER OF LIVES	2			OFF					
	3			O N					
LASER	MANUAL				OFF				
	SEMI-AUTO				O N				
EXTENDED PLAY AT	500,000					OFF			
	NONE					O N			
DEMO SOUND	OFF						OFF		
	O N						ON		
CONTINUE BUY-IN								OFF	
DO NOT CONTINUE BUY-IN								O N	
FLIP SCREEN	OFF								OFF
	O N								O N

NOTES:

1. FACTORY SETTING: ALL SLIDE SWITCHES SET IN THE OFF POSITION EXCEPT FOR THE "NUMBER OF LIVES" OPTION & THE "DEMO SOUND" OPTION.
2. THE DUAL-IN-LINE PACKAGE (DIP) SWITCH "DSW2" IS LOCATED ON THE LOGIC BOARD ASSEMBLY AS SHOWN IN FIGURE 1 ON PAGE 10.
3. THE NUMBER OF LIVES (RABBITS) WILL BE DISPLAYED AS THE NUMBER OF PLAYERS ON THE SCREEN.

SELF-TEST PROCEDURE

A special "Test Mode" is built into the game that allows the Operator and Technician to check the current game Option Switch Settings, to confirm the operation of player input switches and device switches. Also, the Sound section of the Logic Board Assembly is checked by sequencing through a displayed number code using game push buttons.

The Self-Test Mode is entered by turning the game off, then moving the Test Switch (located on the Test Switch Bracket Assembly or on the Coin Door Assembly) to the Test position, and then turning the game back on. The screen will display all of the current DIP switch settings. For additional information, see the OPTION SWITCH SETTINGS on page 11 & 12. All game Options are adjusted thru the use of these DIP switches.

The Switch Test can be accessed when the game is in the Test Mode by moving the Test Switch from the Test Mode to the Game Mode and then back to the Test Mode. When the Switch Test is started, the screen will display the following information.

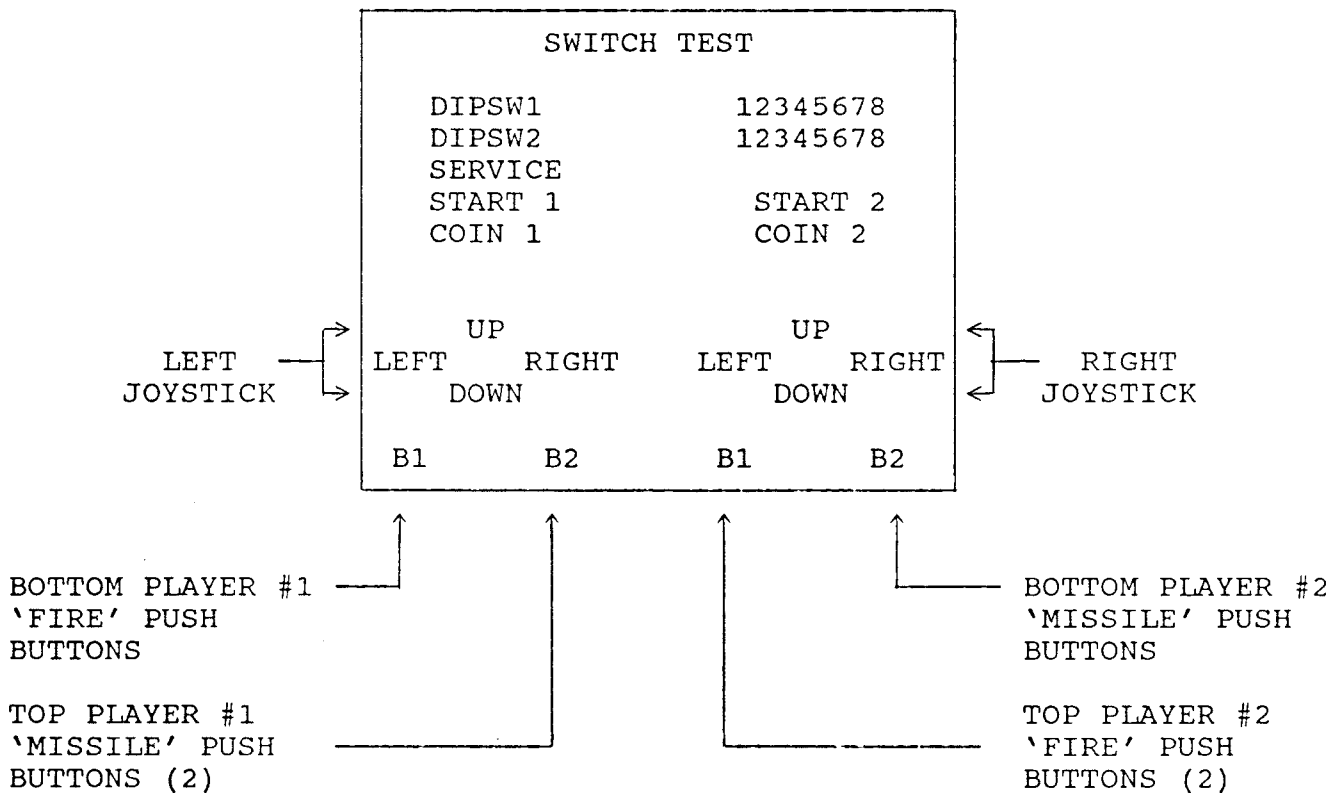

The switches are all normally closed at the rest position. When any of the above switches are operated, the displayed name of that switch changes from white to red until the switch is released. To exit this test, turn the game off and move the Test Switch to the "Game Mode" position. When the game is turned back-on, it will power-up in the "Game Mode" of operation.

The Sound Test can be accessed when the game is in the Test Mode by moving the Test Switch from Test Mode to Game Mode and then back to the Test Mode. When the Sound Test is started, the screen will display the following information.

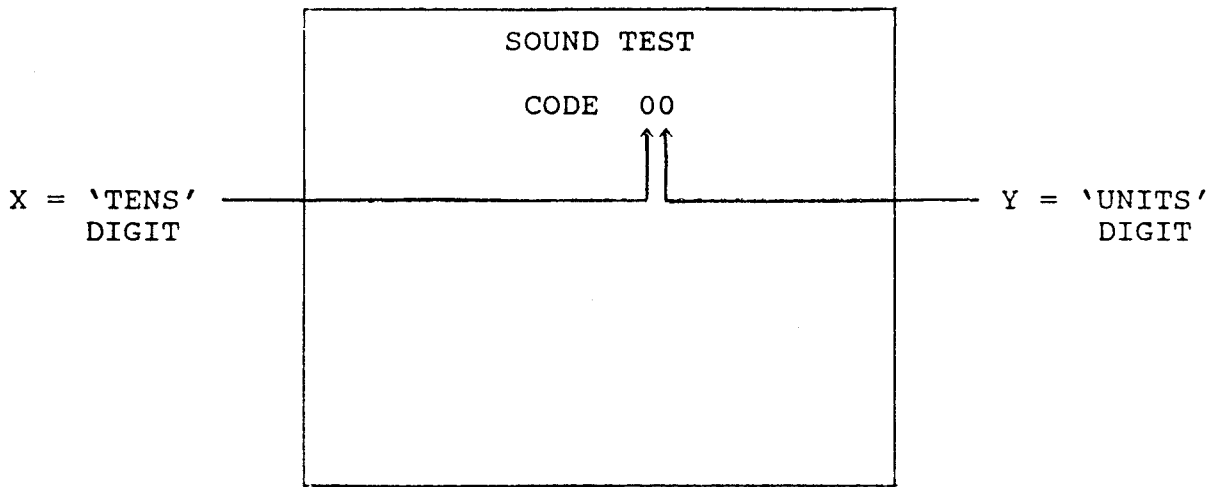

The code numbers displayed are from '0' through '9' and from 'A' through 'F'.

- Pressing either of the bottom PLAYER #1 'FIRE' pushbuttons increases the 'Y' value.
- Pressing either of the bottom PLAYER #2 'FIRE' pushbuttons increases the 'X' value.
- Pressing either of the top PLAYER #1 'MISSILE' pushbuttons decreases the 'Y' value.
- Pressing either of the top PLAYER #2 'MISSILE' pushbuttons decreases the 'X' value.

NOTE: Additional information on the Sound Test is not available at this time.

To exit this test, turn the game off and move the Test Switch to the "Game Mode" position. When the game is turned back-on, it will power-up in the "Game Mode" of operation.

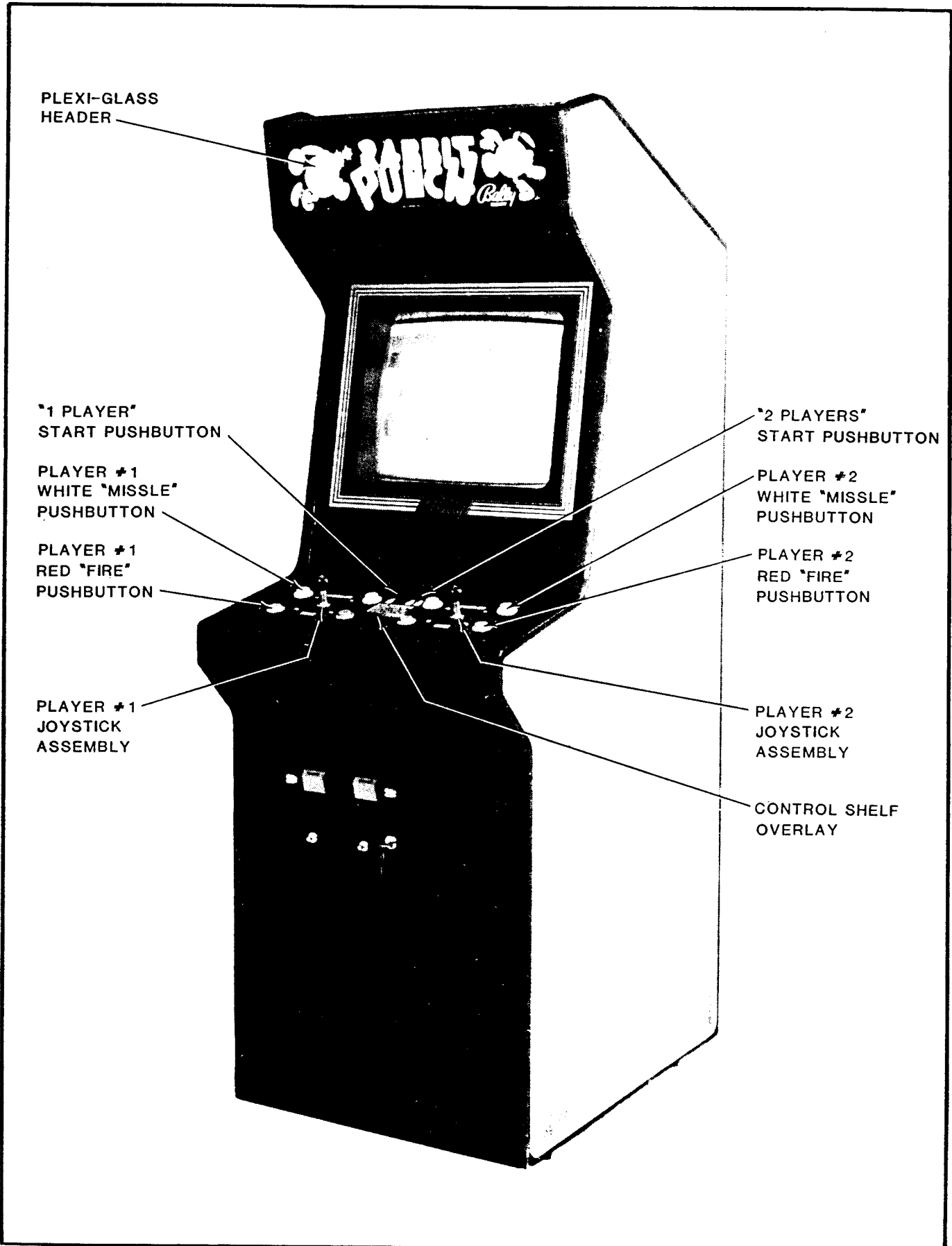

PLEXI-GLASS
HEADER

1 PLAYER
START PUSHBUTTON

PLAYER #1
WHITE "MISSILE"
PUSHBUTTON

PLAYER #1
RED "FIRE"
PUSHBUTTON

PLAYER #1
JOYSTICK
ASSEMBLY

2 PLAYERS
START PUSHBUTTON

PLAYER #2
WHITE "MISSILE"
PUSHBUTTON

PLAYER #2
RED "FIRE"
PUSHBUTTON

PLAYER #2
JOYSTICK
ASSEMBLY

CONTROL SHELF
OVERLAY

FIGURE 2. FIELD KIT ASSEMBLED - FRONT CABINET VIEW

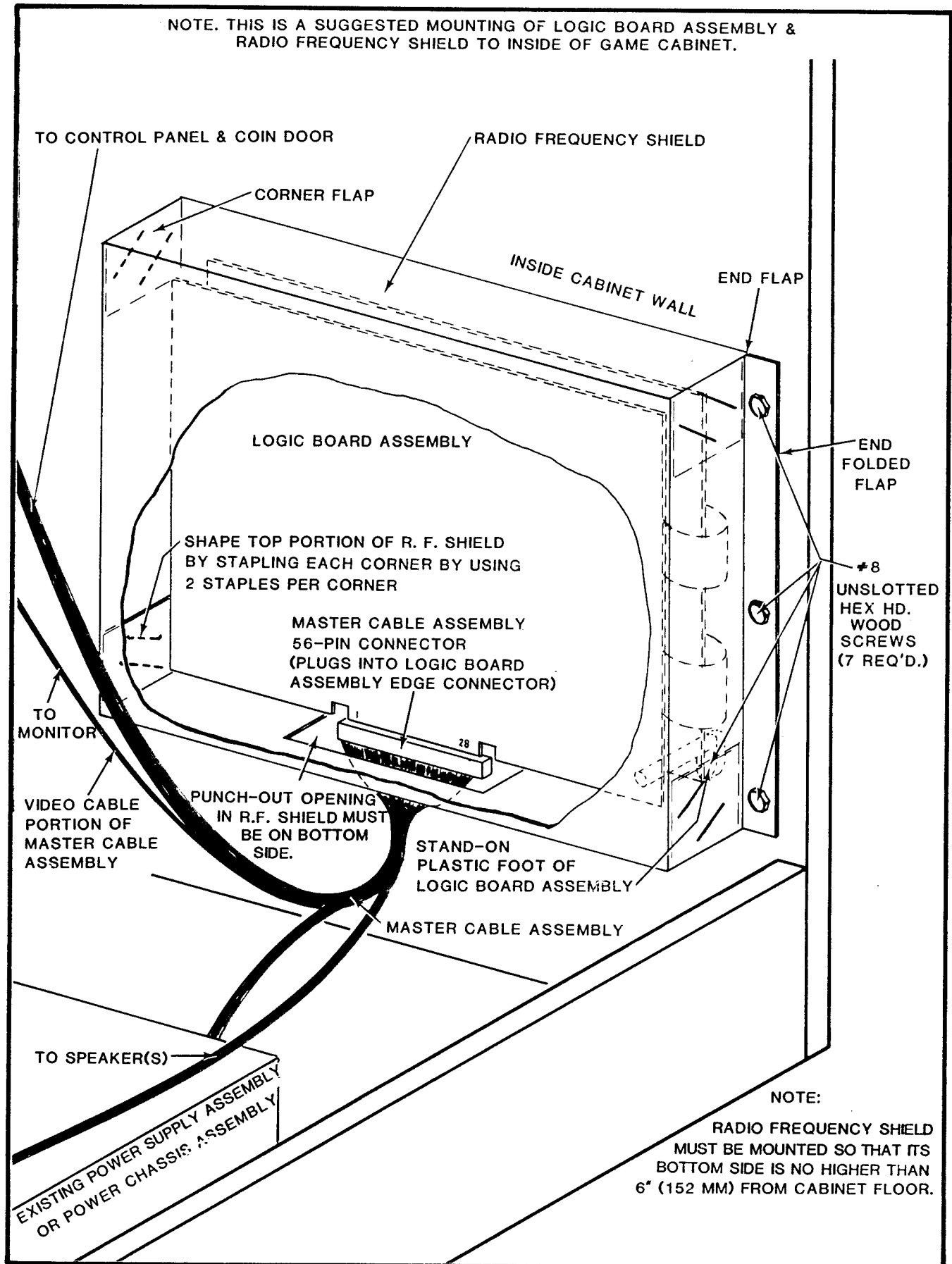

FIGURE 3. FIELD KIT ASSEMBLED - REAR CABINET CLOSE-UP VIEW

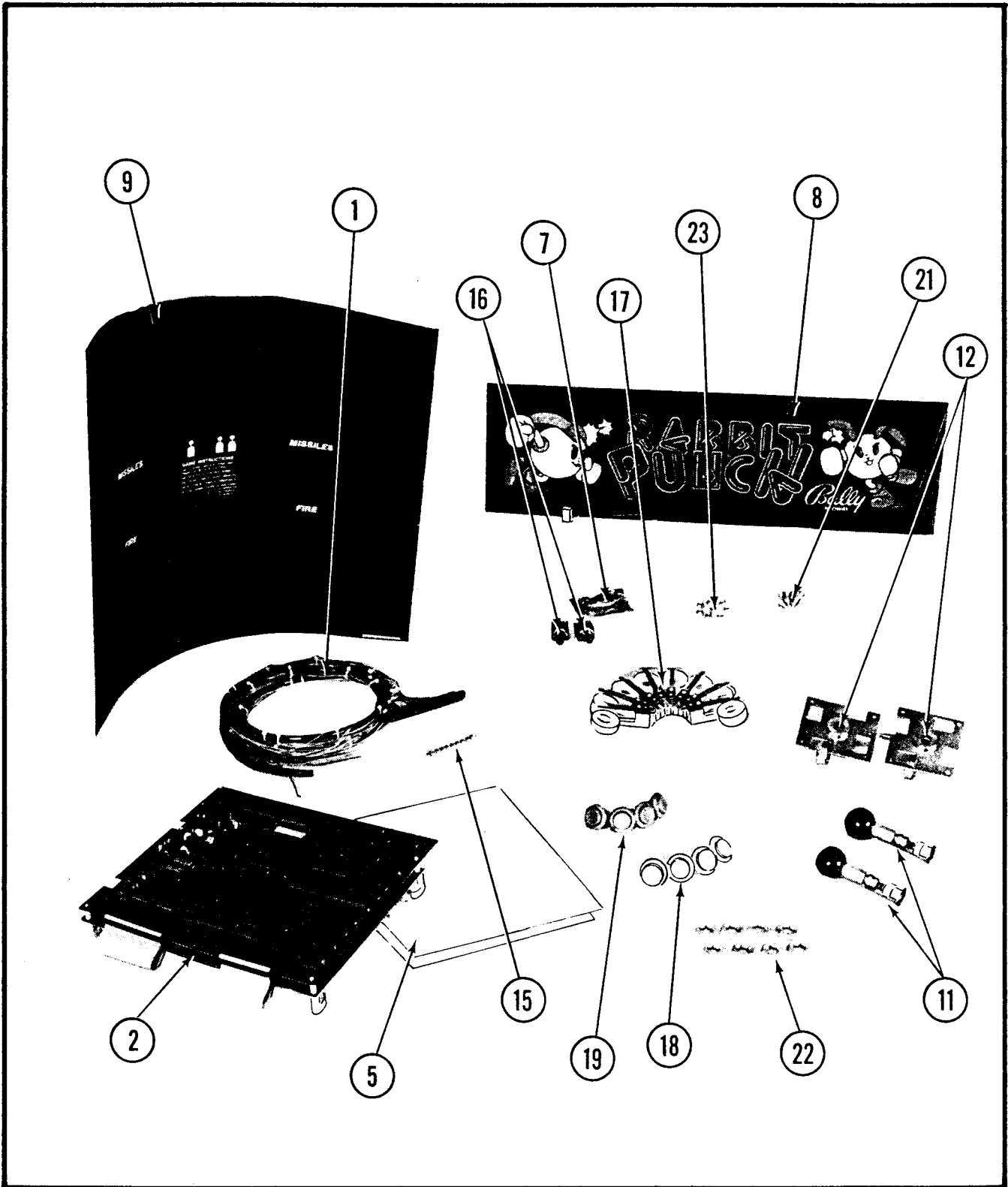

FIGURE 4. FIELD KIT COMPONENT PARTS

FIELD KIT PARTS LIST

PART NO. GF12-00001-0000

<u>ITEM</u>	<u>PART NUMBER</u>	<u>DESCRIPTION</u>	<u>QTY</u>
1	AF12-00007-0000	MASTER CABLE ASSEMBLY	1
2	B084-91946-A000	RABBIT PUNCH LOGIC BOARD ASSEMBLY	1
3	FORM-00338-8207	GAME UNIT CONTROL TAG	1
4*	M051-00F12-A001	GAME CONTROL TAG	1
5	M051-00F12-A007	OPTION SWITCH SETTINGS TAG	1
6*	M051-00F12-A013	RABBIT PUNCH INSTRUCTION MANUAL	1
7	M051-00113-0000	FCC CLASS A COMPLIANCE LABEL	1
8	OF12-00902-0000	PLEXI-GLASS HEADER	1
9	OF12-00903-0000	CONTROL SHELF OVERLAY	1
10*	OF12-00905-0000	RADIO FREQUENCY SHIELD	1
11	0017-00009-0645	JOY-STICK ASSEMBLY SHAFT W/BALL	2
12	0017-00009-0686	JOY-STICK ASSEMBLY PLATE W/SWITCH	2
13	0017-00021-0259	KK-156 HOUSING	1
14*	0017-00021-1178	KK-156 HOUSING	1
15*	0017-00021-1347	KK-156 TERMINAL	10
16	0017-00032-0092	SINGLE POLE DOUBLE THROW MOMENTARY PUSH BUTTON SWITCH	2
	0017-00032-0051	RED BUTTON SWITCH	2
**		HEX NUT 7/32" X 32	1
**		INTERNAL STAR WASHER .595", .437", .031"	1
17	0017-00032-0093	SWITCH W/WHITE HOLDER	8
18	0017-00042-0300	PUSH BUTTON-WHITE, ROUND	4
19	0017-00042-0304	PUSH BUTTON-RED, ROUND	4
20	0017-00101-0141	#8 X 11/16" UNSLOTTED HEX HEAD SCREW W/WASHER	7
21	0017-00101-0620	#8-32 X 1/2" ROUND HEAD CARRIAGE BOLT	8
22	0017-00103-0054	PAL NUT 5/8" X 11/16"	8
23	0017-00103-0061	#8-32 HEX W/SEMS NUT	8
24	0017-00103-0089	HEX NUT 5/8" X 1-1/2"	2
25*	0017-00104-0026	#8 WASHER .171", .500", .032	3

* NOT SHOWN IN FIGURE 5 ON PAGE 22.

** PART NUMBER NOT LISTED BECAUSE THESE ARE SUB-PARTS OF THE SWITCH.

NOTE: THIS IS A SUGGESTED MOUNTING OF NEW CONTROLS ON EXISTING CONTROL SHELF.

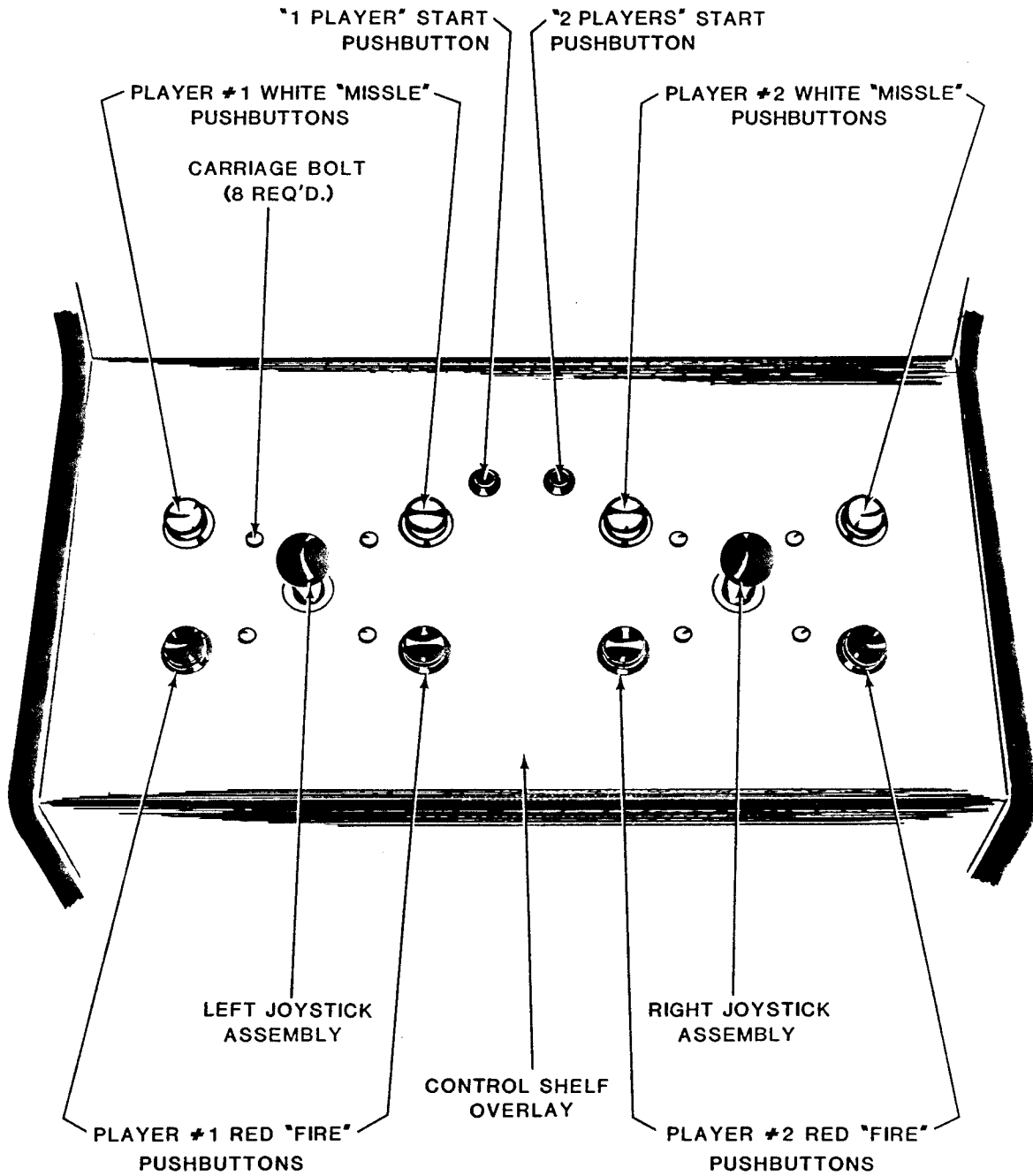

FIGURE 5. CONTROL PANEL ASSEMBLY - FRONT VIEW

NOTE: THIS IS A SUGGESTED MOUNTING OF NEW CONTROLS ON EXISTING CONTROL SHELF.

OPTION 2: SOLDER DRESSED BARE WIRE ENDS OF NEW MASTER CABLE ASSEMBLY TO TERMINATING LOCATIONS ON CONTROLS - REFER TO WIRING CHART ON PAGE 23.

OPTION 1: MAKE WIRING CONNECTIONS TO NEW MASTER CABLE ASSEMBLY BY USING OWN WIRES & TERMINALS WITH EXISTING CONTROL PANEL CABLE CONNECTOR HOUSING(S) & EXISTING MASTER CABLE CONNECTOR HOUSING(S) - REFER TO WIRING CHART ON PAGE 23.

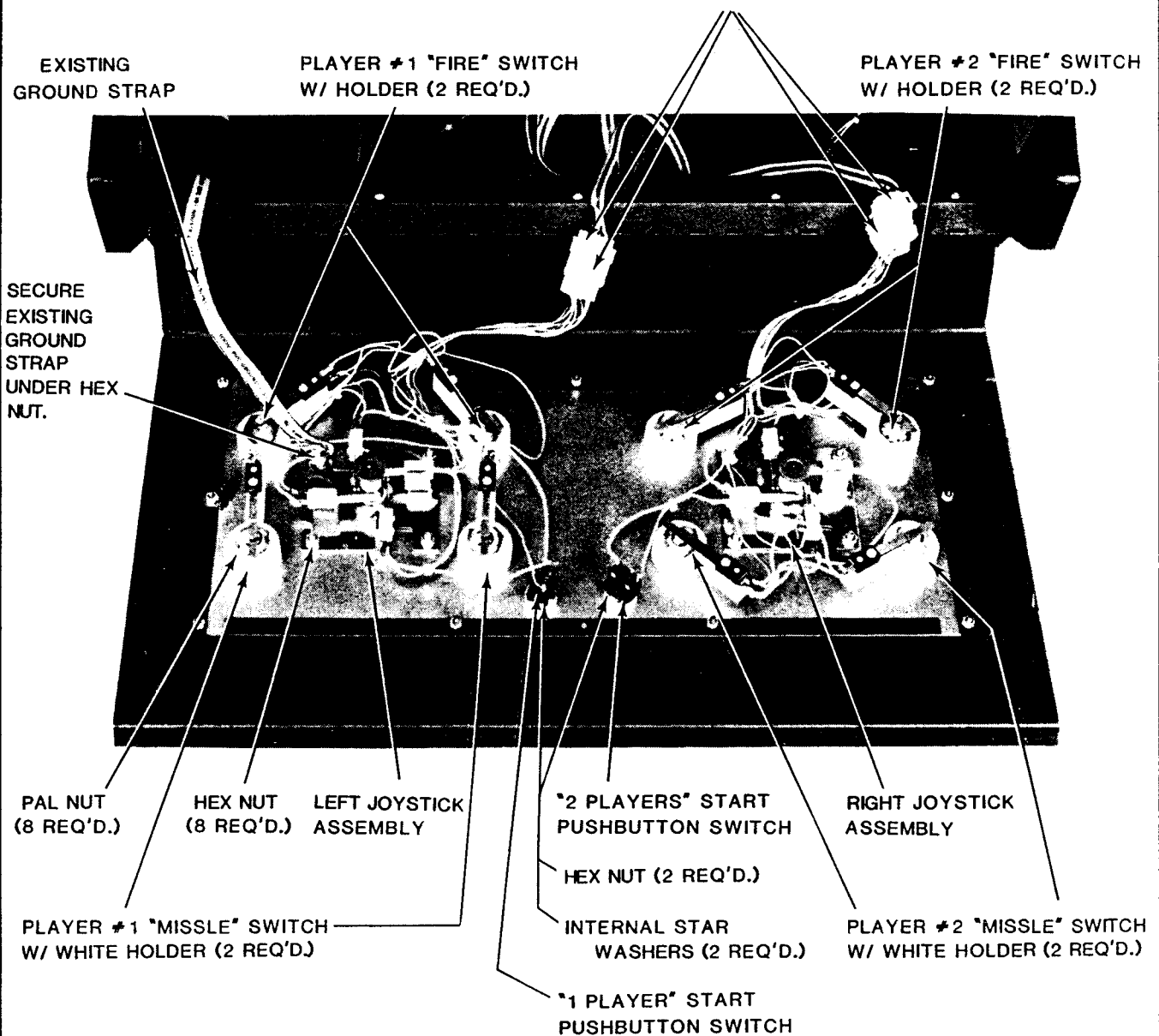

FIGURE 6. CONTROL PANEL ASSEMBLY - REAR VIEW

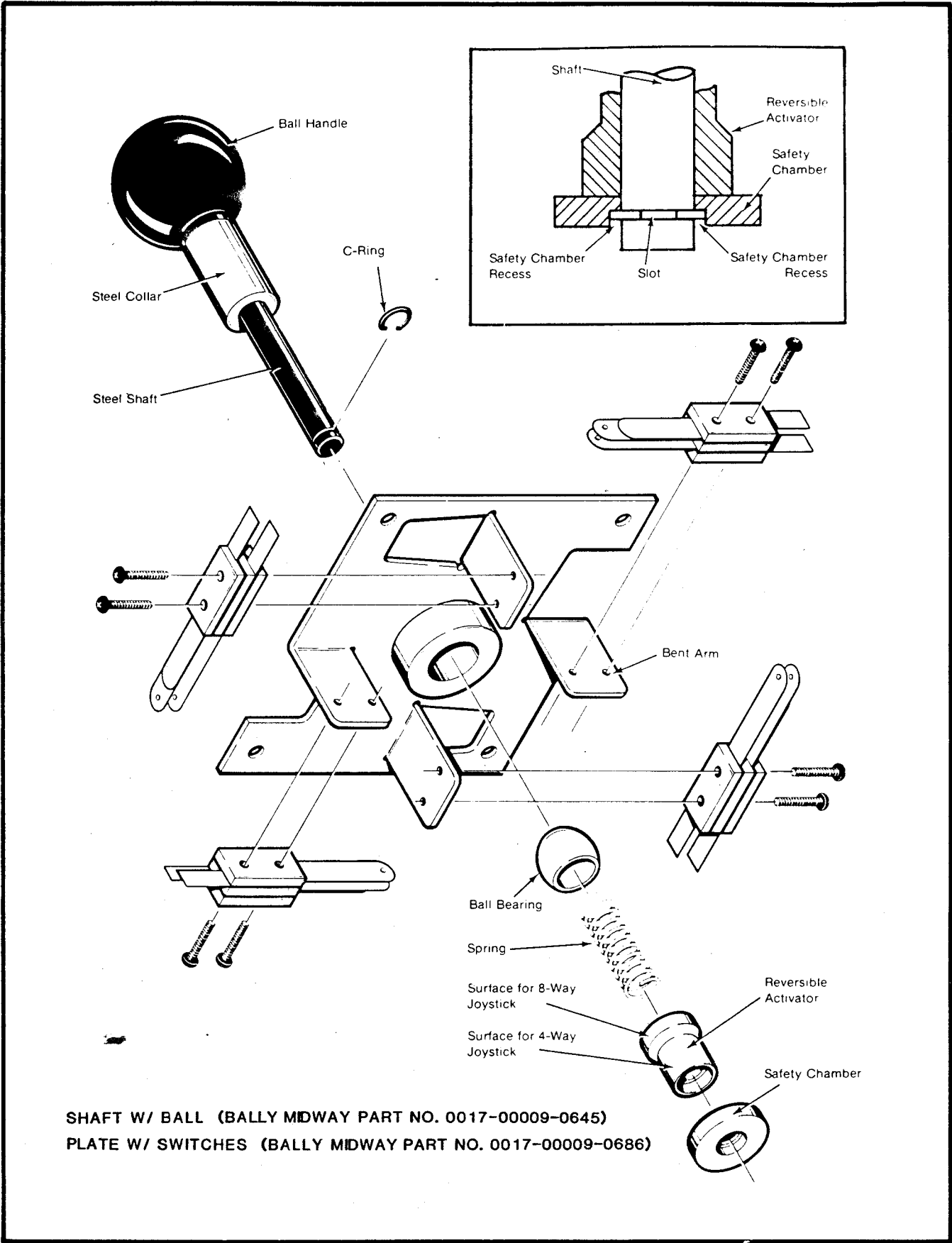

FIGURE 7. JOYSTICK ASSEMBLY

WIRING CHART

MASTER CABLE ASSEMBLY 56-PIN CONNECTOR

WIRE COLOR	SOLDER SIDE	PIN	PIN	COMPONENT SIDE	WIRE COLOR
BLACK*	GROUND	A	1	GROUND	BLACK*
RED*	+5VDC	B	2		
RED*	+5VDC	C	3	+5VDC	RED*
		D	4	+5VDC	RED*
		E	5		
		F	6	+12VDC	BROWN@
		H	7		
		J	8		
		K	9		
GRAY	SPEAKER (-)	L	10	SPEAKER (+)	GRAY-BLACK
		M	11		
GREEN~	GREEN VIDEO INPUT	N	12	RED VIDEO INPUT	RED~
VIOLET~	NEGATIVE COMPOSITE SYNC VIDEO INPUT	P	13	BLUE VIDEO INPUT	BLUE~
YELLOW	SERVICE (CREDIT)	R	14	VIDEO INPUT GROUND	BLACK~
		S	15	TEST	WHITE
BLUE-BLACK	COIN 1	T	16	COIN 2	BLUE-WHITE
GREEN-BLACK	2P START	U	17	1P START	GREEN-YELLOW
YELLOW-BLACK	2P UP	V	18	1P UP	YELLOW-WHITE
YELLOW-BROWN	2P DOWN	W	19	1P DOWN	YELLOW-BLUE
RED-BLACK	2P LEFT	X	20	1P LEFT	RED-WHITE
BLUE-YELLOW	2P RIGHT	Y	21	1P RIGHT	BLUE-GREEN
ORANGE-GREEN	2P MISSILE	Z	22	1P MISSILE	ORANGE-RED
WHITE-BLACK	2P FIRE/PUNCH	a	23	1P FIRE/PUNCH	WHITE-BROWN
		b	24		
		c	25		
		d	26		
		e	27		
BLACK*	GROUND	f	28	GROUND	BLACK*

* 18 AWG, 300VDC WIRE

@ DRIVES SOUND SECTION OF LOGIC BOARD ASSEMBLY

~ VIDEO CABLE PORTION OF MASTER CABLE ASSEMBLY

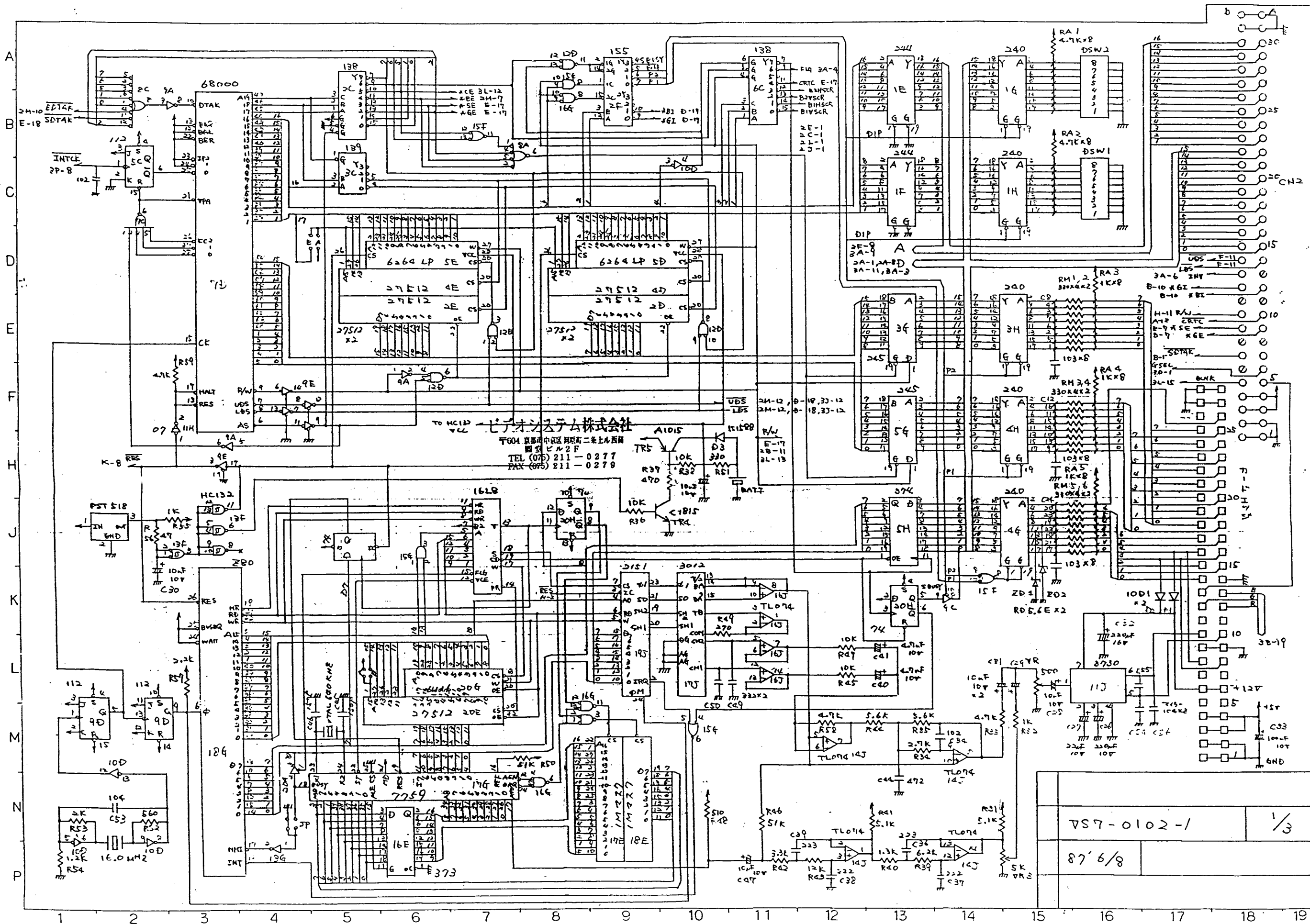

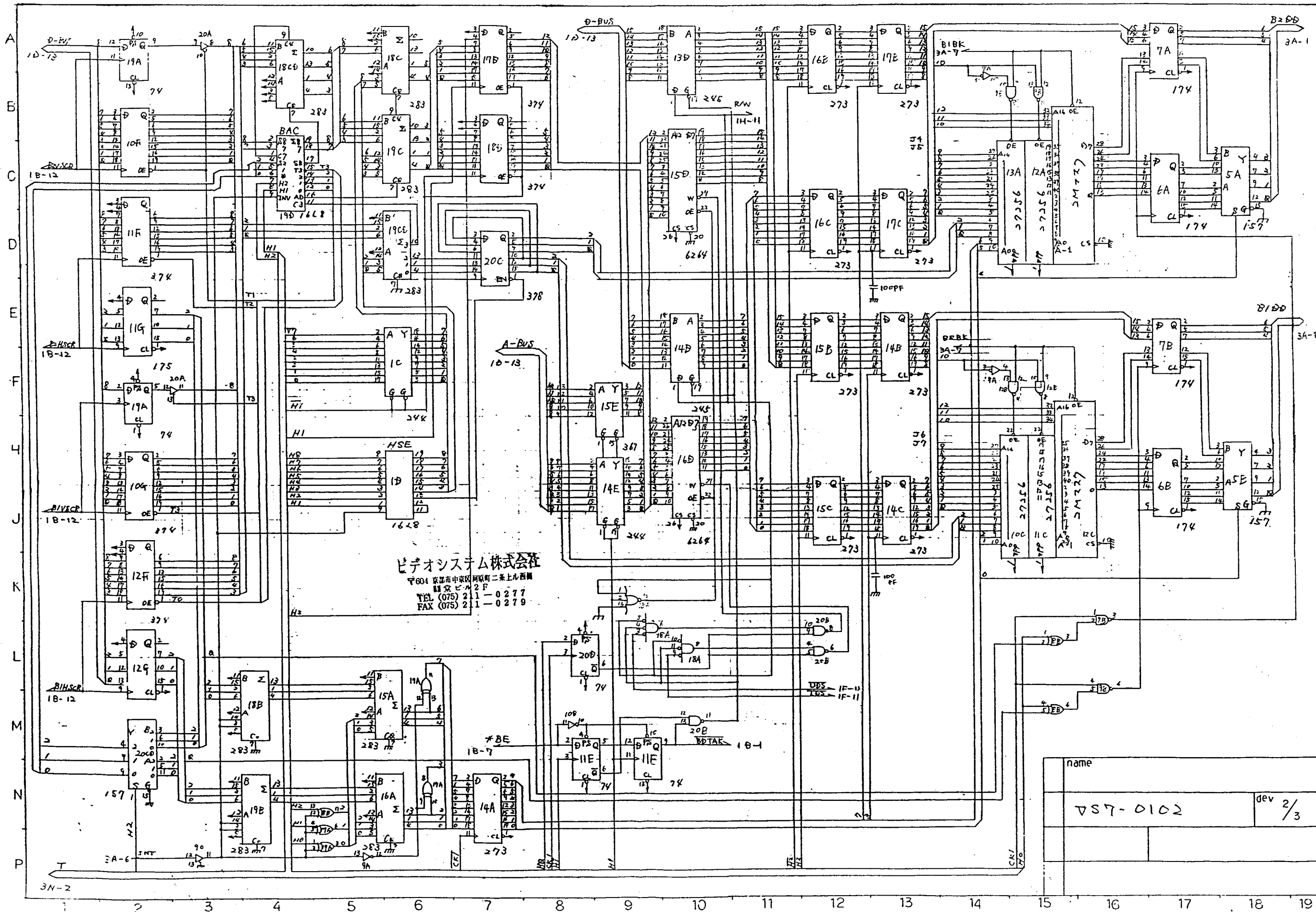

name	
VST-0102	dev 2/3

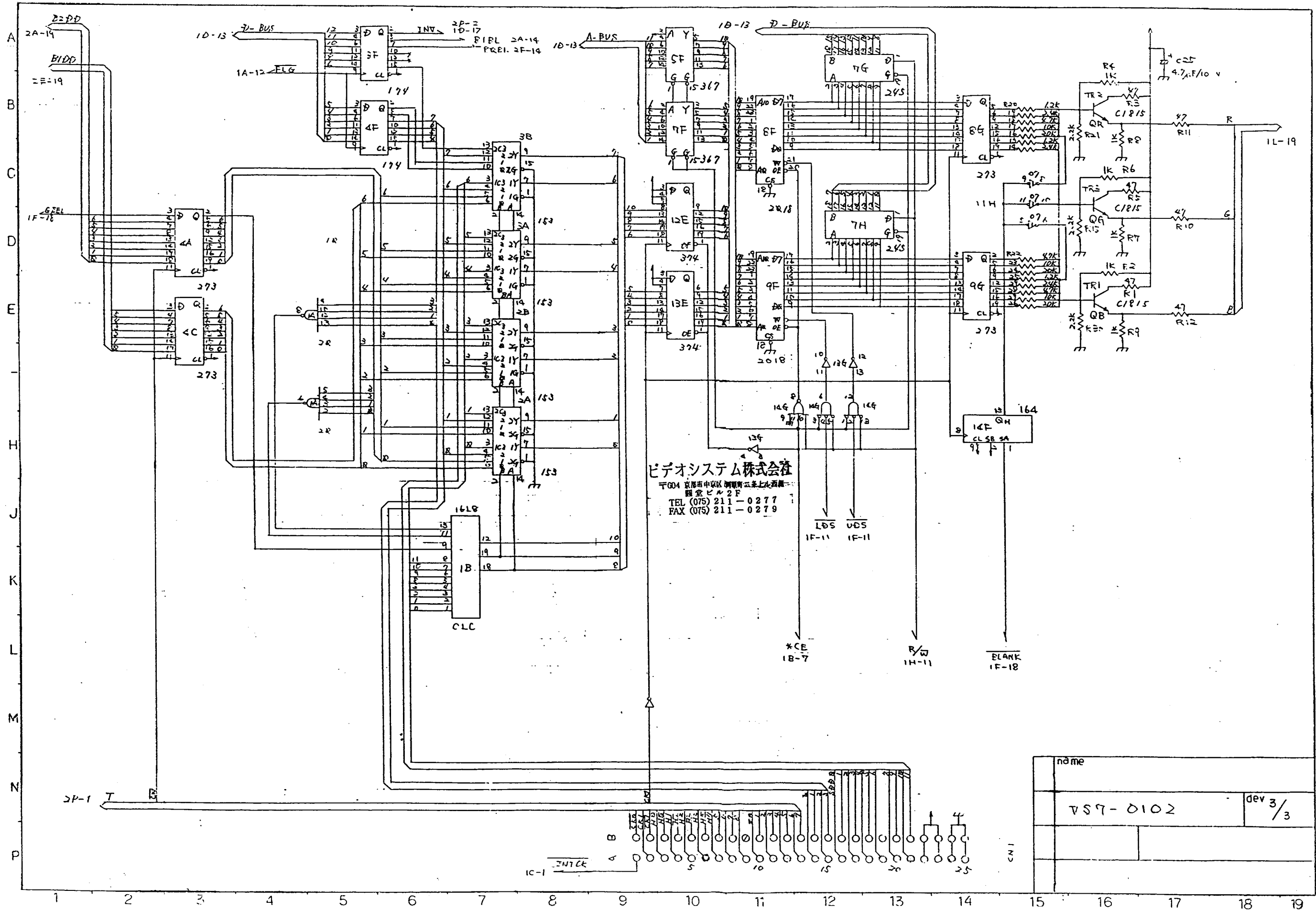

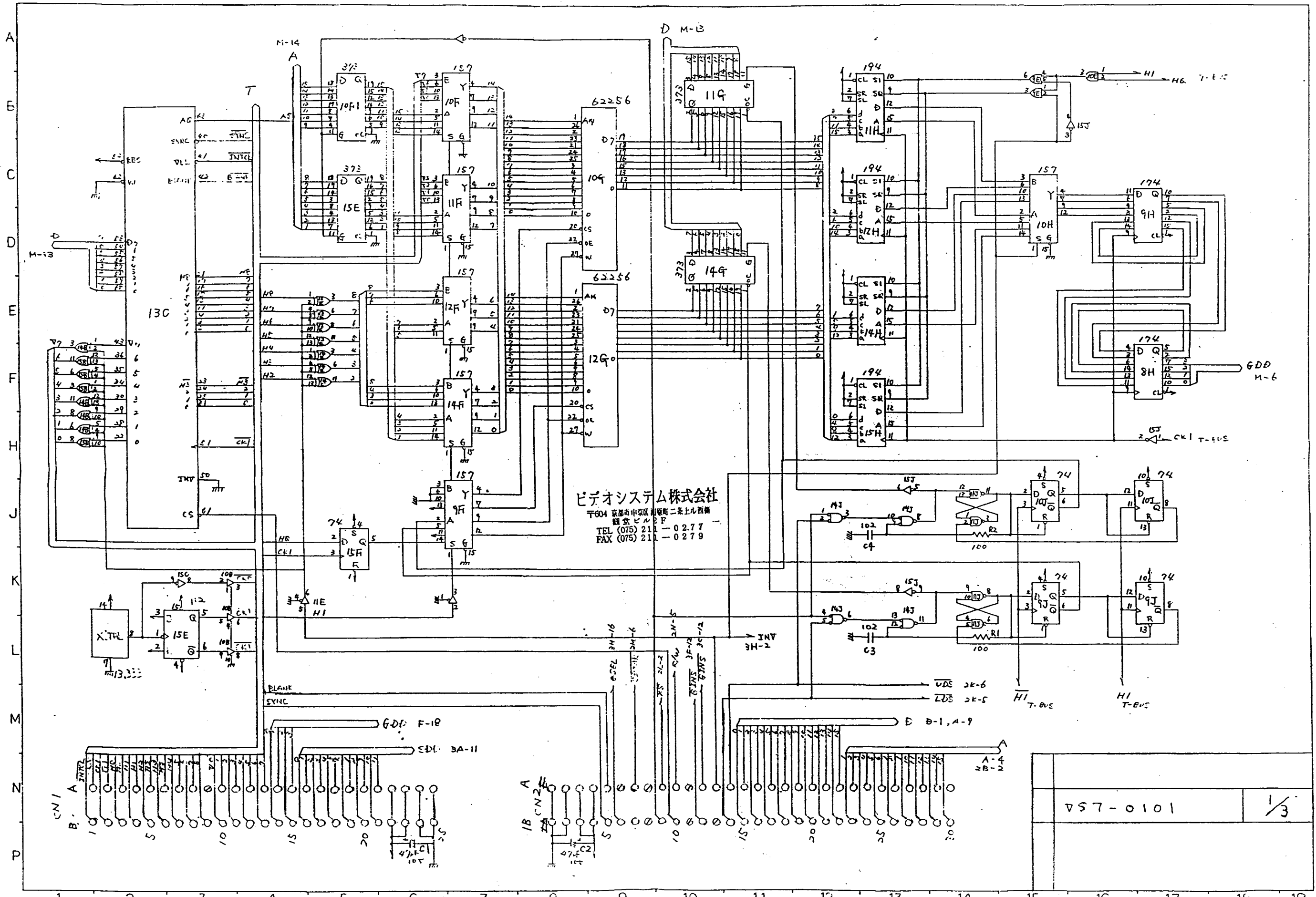

ビデオシステム株式会社
 〒604 京都市中京区御所町二条上ル西側
 電話 ビデオ 211-0277
 TEL (075) 211-0277
 FAX (075) 211-0279

V57-0101 1/3

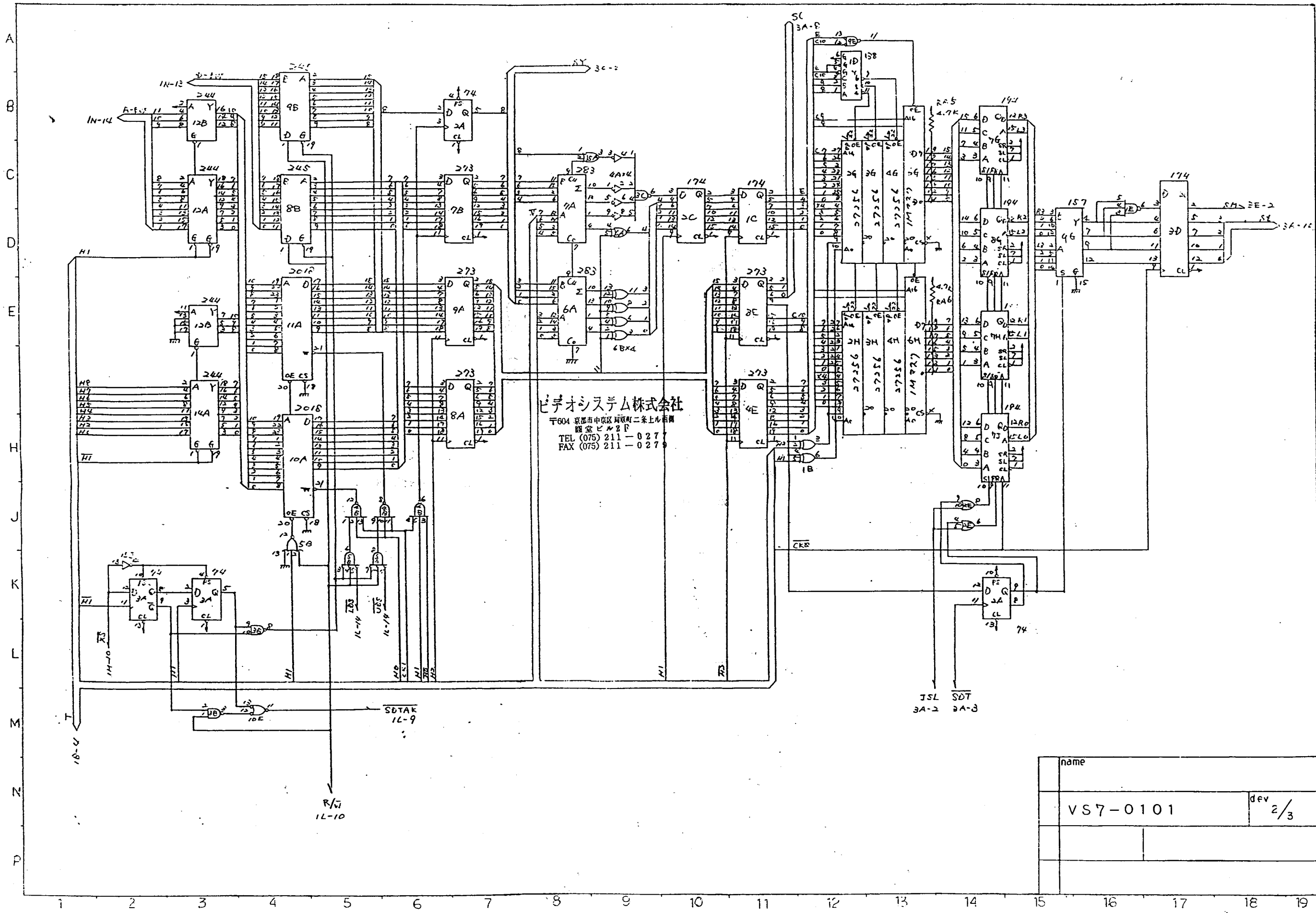

ピリオシステム株式会社
 〒604 京都市中京区河原町二条上ル西側
 観音ビル2F
 TEL (075) 211-0277
 FAX (075) 211-0279

name	
VS7-0101	dev 2/3

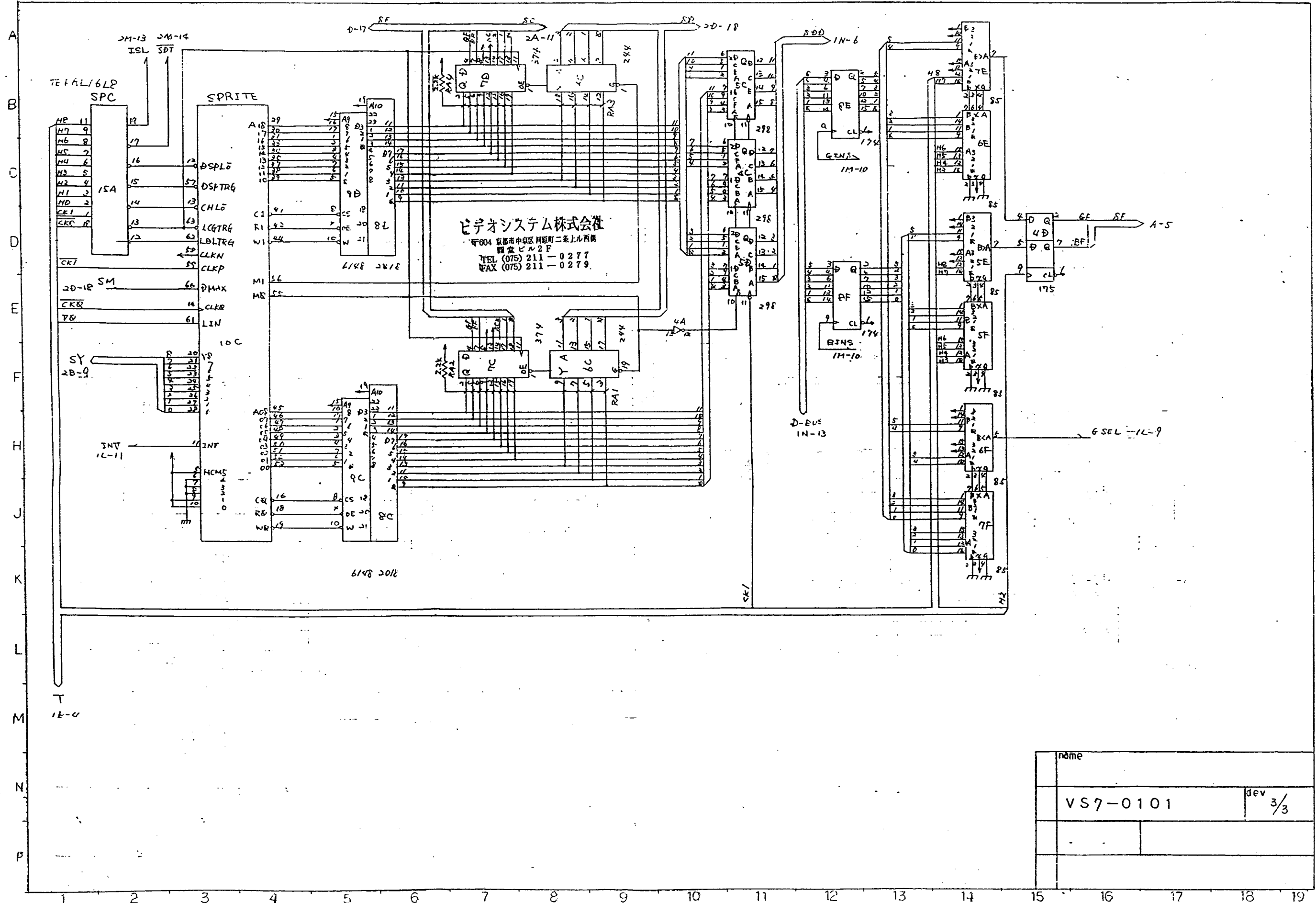

ビデオシステム株式会社
 〒604 京都市中京区河原町二条上ル西側
 西宮ビル2F
 TEL (075) 211-0277
 FAX (075) 211-0279

name	
VS7-0101	dev 3/3