



TM-360
1st printing



Race Drivin'TM **Compact**

Operator's Manual

***SUPER
STUNT
TRACK***

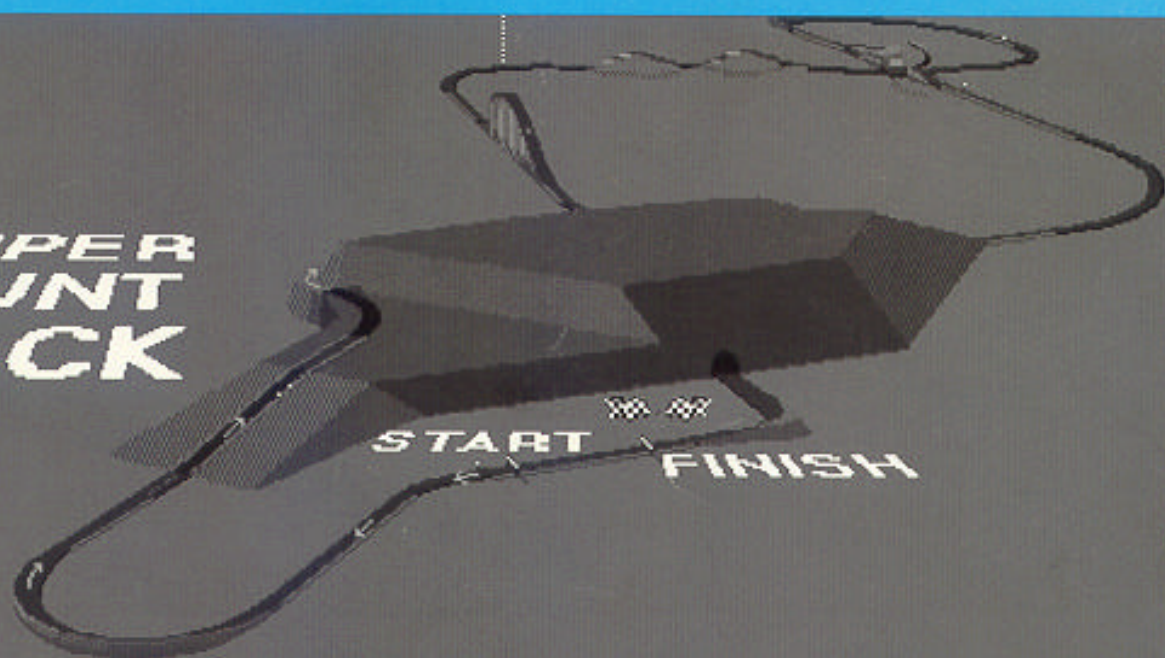

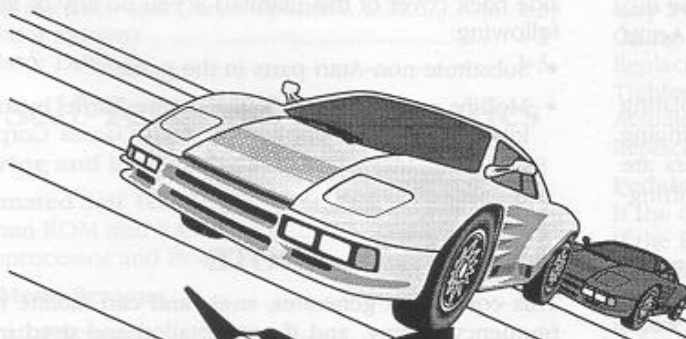

Race Drivin' Compact

Operator's Manual

- 4 Illustrated Parts Lists
- Statistics Sheet

Patents are pending on several parts of the Race Drivin' Compact simulator.

Contents

Introduction

Getting Started

Operating the Simulator

Special Functions Screen

DIP Switches

Troubleshooting

Maintaining and Inspecting

Coin Mechanism

Copyright © 1989, 1990 by Atari Games Corporation. All rights reserved.

No part of this publication may be reproduced by any means, including mechanical, photocopying, recording, or by any information storage and retrieval system, without the prior written permission of the publisher.

The game play, all graphics, and all other elements of the Race Drivin' Compact simulator are the property of Atari Games Corporation. All other elements are the property of their respective owners.

The Atari Games Corporation is not responsible for any damage to your equipment or any loss of data that may occur while using this simulator. It is the responsibility of the user to ensure that the simulator is used in a safe and secure environment.

Published by Atari Games Corporation, 2000 Westborough Road, Westborough, MA 01581.

Copyright © 1989, 1990 by Atari Games Corporation. All rights reserved.

No part of this publication may be reproduced by any mechanical, photographic or electronic process, or in the form of a phonographic recording, nor may it be stored in a retrieval system, transmitted, or otherwise copied for public or private use, without permission from the publisher.

The game play, all graphic designs, this technical manual, its accompanying schematic diagrams, and the display manual are protected by the U.S. Copyright Act of 1976.

This Act provides for substantial penalties for violating federal copyright laws. Courts can impound infringing articles while legal action is pending. If infringers are convicted, courts can order destruction of the infringing articles.

In addition, the Act provides for payment of statutory damages of up to \$50,000 per infringing transaction in certain cases. Infringers may also have to pay costs and attorneys' fees and face an imprisonment of up to five years as well as fines of up to \$250,000 in the case of individuals and up to \$500,000 in the case of corporations.

Atari Games Corporation will aggressively enforce its copyrights against infringers. We will use all legal means to immediately halt any manufacture, distribution, or operation of a copy of video games made by us. Anyone who purchases such copies risks forfeiting such a game.

Published by:
Atari Games Corporation
675 Sycamore Drive
P.O. Box 361110
Milpitas, California 95036

Printed in the U.S.A 11/90

Produced by the Atari Games Technical Publications Department.

Technical Writing and Editing: Andrea Dencker
Illustration and Design: Mary Ohanessian Sumner

Notice Regarding Non-Atari® Parts

WARNING

Use of non-Atari parts or modifications of any Atari game circuitry may adversely affect the safety of your game, and may cause injury to you and your players.

You may void the game warranty (printed on the inside back cover of this manual) if you do any of the following:

- Substitute non-Atari parts in the game.
- Modify or alter any circuits in the game by using kits or parts *not* supplied by Atari Games Corporation.

NOTE

This equipment generates, uses, and can radiate radio frequency energy, and if not installed and used in accordance with the instruction manual, may cause interference to radio communications. It has been tested and found to comply with the limits for a Class A computing device pursuant to Subpart J of Part 15 of Federal Communications Commission (FCC) Rules, which are designed to provide reasonable protection against such interference when operated in a commercial environment. Operation of this equipment in a residential area or modification to this equipment is likely to cause interference, in which case the user, at his own expense, will be required to take whatever measures may be required to correct the interference. If you suspect interference from an Atari game at your location, check the following:

- All ground wires in the game are properly connected as shown in the game wiring diagram.
- The power cord is properly plugged into a grounded three-wire outlet.
- On games provided with an Electromagnetic Interference (EMI) ground cage, be sure that the game printed-circuit boards (PCBs) are properly installed on the EMI ground cage and that the end board is securely installed with **all** screws in place and tightened.

If you are still unable to solve the interference problem, please contact Customer Service at Atari Games Corporation. See the inside front cover of this manual for service in your area.

Contents

1 Set Up

How to Use This Manual	1-1
Operating the Simulator	1-2
Inspecting the Simulator.....	1-2
Adjusting the Glides	1-2
Control and Switch Locations	1-2
Setting the Coin and Game Options.....	1-3
Simulator Systems	1-3
Simulator Driving	1-3

2 Self-Test and Diagnostics

Entering and Exiting the Self-Test	2-3
Automated Self Test	2-3
Program ROM and RAM Test	2-3
Microprocessor and Board Tests.....	2-4
Test Menu Screens	2-4
Operator Screens	2-5
Coin Options.....	2-5
Game Difficulty.....	2-8
Game Options.....	2-8
Statistics	2-9
Histogram	2-10
Error Count	2-10
Games Played by Day and Hour	2-10
Set Controls Screens	2-10
Control Inputs Screen	2-11
Monitor Test Patterns	2-12
Set Clock Screen	2-12
Disable Broken Controls Screen	2-13
Special Functions Screen	2-13
Multisync Board GSP Tests.....	2-14
Multisync Board Controls	2-15
Steering Wheel Submenu	2-15
Link Connector Test.....	2-16
Multisync Board ROM Checksums.....	2-16
Multisync Board ZRAM Test.....	2-16
ADSP Board Tests	2-16
Sound Board	2-17
DSK Board Tests	2-18
LEDs on the Multisync PCB	2-19
DIP Switches	2-19

3 Maintenance and Troubleshooting

Maintaining and Inspecting	3-2
Coin Mechanism	3-3

Maintaining the Coin Mechanism	3-3
--------------------------------------	-----

Dashboard	3-3
Removing the Dashboard	3-3
Installing the Dashboard	3-3

Interior Components	3-4
Cleaning the Interior Components	3-4

Key Switch Assembly	3-4
Oiling the Key Switch Assembly.....	3-4
Replacing the Spring in the Key Switch Assembly.....	3-4
Tightening the Screw in the Key Switch Assembly	
Actuator.....	3-5
Replacing the Switch on the Key Switch Assembly.....	3-5

Pedals	3-6
If the Gas or Clutch Pedal Does Not Work	3-6
If the Brake Pedal Does Not Work	3-6
Greasing and Checking the Pedals	3-6
Replacing a Pedal	3-6
Replacing a Spring	3-7
Replacing the Clutch and Gas Pedal	
Potentiometers	3-9
Testing the Brake Pedal Strain Gauge and	
Bonding.....	3-9
Replacing the Brake Strain Gauge	3-11

Shifter Assembly	3-11
Lubricating the Shifter.....	3-11
Replacing a Shifter Switch.....	3-11

Speakers	3-12
Removing a Speaker	3-12

Static-Sensitive Devices	3-12
Replacing Static-Sensitive Devices	3-12

Steering Assembly	3-12
Oiling the Bronze Bearing.....	3-12
Adjusting the Steering Belt	3-12
Replacing the Steering Belt	3-12
Replacing the Steering Motor	3-13
Replacing the Encoder or Centering PCB.....	3-16
Replacing the Centering Disk.....	3-18
Replacing the Encoder Disk	3-20

Video Display	3-21
Adjusting the Video Display	3-21
Removing the Video Display	3-21
Replacing the Video Display	3-22

4 Illustrated Parts Lists

See the list of Illustrations that follows.

Statistics Sheet

Copyright © 1989, 1990
 Corporation. All rights reserved.

Illustrations

Figure 2-1	Program ROM and RAM Test Screen..	2-3
Figure 2-2	Microprocessor and Board Tests Screen.....	2-3
Figure 2-3	Instructions for Test Menu Screen	2-4
Figure 2-4	Test Menu Screen	2-4
Figure 2-5	Coin Options Screen	2-4
Figure 2-6	Game Difficulty Screen	2-5
Figure 2-7	Custom Game Options Screen.....	2-8
Figure 2-8	Game Options Screen	2-8
Figure 2-9	Statistics Screen.....	2-9
Figure 2-10	Histogram Screen.....	2-10
Figure 2-11	Games Played by Day and Hour Screen	2-11
Figure 2-12	First Set Controls Screen	2-11
Figure 2-13	Control Inputs Screen	2-11
Figure 2-14	Set Clock Screen	2-12
Figure 2-15	Disable Broken Controls Screen	2-13
		
Figure 2-16	Special Functions Screen.....	2-13
Figure 2-17	GSP Tests Screen	2-14
Figure 2-18	Multisync Board Controls Screen	2-15
Figure 2-19	Pots: 8-Bit Screen	2-15
Figure 2-20	Steering Wheel Submenu Screen.....	2-15
Figure 2-21	Send Force Screen	2-17
Figure 2-22	Link Connector Test Screen	2-16
Figure 2-23	ROM Checksums Screen	2-16
Figure 2-24	ADSP Board Tests Screen.....	2-17
Figure 2-25	ADSP ROM Checksums Tests Screen.....	2-18
Figure 2-26	Sound Board Tests Screen.....	2-18

Figure 2-27	Sound Board Sound Wave ROM Checksums Screen.....	2-18
Figure 2-28	DSK Board Test Screen	2-19
Figure 2-29	DIP Switch and LED Locations on the Multisync PCB	2-20
Figure 3-1	Gas or Clutch Pedal is Not Working or Is Working Erratically and You Have Tried the <i>Set Controls</i> Screens.....	3-8
Figure 3-2	Brake Pedal is Not Working or Working Erratically and You Have Tried the <i>Set Controls</i> Screens.....	3-10
Figure 3-3	The Steering Wheel Continuously Turns in One Direction and You Have Tried the <i>Set Controls</i> Screens	3-15
Figure 3-4	Installing the Steering Pivot Shaft	3-16
Figure 3-5	The Steering Wheel is Jerky and You Have Tried the <i>Set Controls</i> Screens	3-17
Figure 3-6	The Steering Wheel Has No Feedback and You Have Tried the <i>Set Controls</i> Screens	3-19
Figure 4-1	Cabinet-Mounted Assemblies.....	4-2
Figure 4-2	Dashboard Assembly.....	4-4
Figure 4-3	Steering Assembly.....	4-6
Figure 4-4	Shifter Assembly	4-8
Figure 4-5	Key Switch Assembly	4-9
Figure 4-6	Brake and Gas Pedal Assembly	4-10
Figure 4-7	Clutch Pedal Assembly.....	4-11
Figure 4-8	Coin Acceptors, Inc. Coin Door Assembly	4-12
Figure 4-9	Power Supply Assembly.....	4-15
Figure 4-10	Hard Drivin' Compact Multisync PCB Assembly.....	4-18
Figure 4-11	APU PCB Assembly	4-24
Figure 4-12	Motor Amplifier PCB Assembly	4-26
Figure 4-13	Encoder Disk PCB Assembly.....	4-28
Figure 4-14	Centering Disk PCB Assembly	4-28

Tables

Table 1-1	Simulator Specifications.....	1-2	Table 3-3	Troubleshooting All Controls.....	3-3
Table 2-1	Using the Self-Test Screens and Diagnostics.....	2-2	Table 3-4	Troubleshooting the Key Switch.....	3-5
Table 2-2	Coin Option Settings.....	2-5	Table 3-5	Troubleshooting the Clutch or Gas Pedal.....	3-7
Table 2-3	Summary of All Screens Appearing in the Self-Test.....	2-6	Table 3-6	Troubleshooting the Brake Pedal.....	3-10
Table 2-4	Game Option Settings.....	2-8	Table 3-7	Pedal Potentiometers Harness Connections.....	3-11
Table 2-5	When to Use the Special Function Items.....	2-14	Table 3-8	Troubleshooting the Shifter.....	3-11
Table 2-6	LED Status.....	2-19	Table 3-9	Harness Connections to the Shifter Switches.....	3-12
Table 2-7	Using the DIP Switches.....	2-21	Table 3-10	Troubleshooting the Speakers.....	3-13
Table 3-1	Maintenance and Inspection Items.....	3-2	Table 3-11	Troubleshooting the Steering Assembly.....	3-14
Table 3-2	Voltage Inputs and Test Points on the Simulator PCBs.....	3-2	Table 3-12	Torque Table for the Screws on the Steering Assembly.....	3-18
			Table 3-13	Troubleshooting the Video Display... ..	3-22

ABOUT NOTES, CAUTIONS, AND

WARNINGS

Read the instructions, notes, cautions, and warnings carefully before using the simulator. The simulator is a complex piece of equipment and should be used only by trained personnel.

The simulator is a complex piece of equipment and should be used only by trained personnel. The simulator is a complex piece of equipment and should be used only by trained personnel.

The simulator is a complex piece of equipment and should be used only by trained personnel. The simulator is a complex piece of equipment and should be used only by trained personnel.

The simulator is a complex piece of equipment and should be used only by trained personnel. The simulator is a complex piece of equipment and should be used only by trained personnel.

The simulator is a complex piece of equipment and should be used only by trained personnel. The simulator is a complex piece of equipment and should be used only by trained personnel.

The simulator is a complex piece of equipment and should be used only by trained personnel. The simulator is a complex piece of equipment and should be used only by trained personnel.

The simulator is a complex piece of equipment and should be used only by trained personnel. The simulator is a complex piece of equipment and should be used only by trained personnel.

The simulator is a complex piece of equipment and should be used only by trained personnel. The simulator is a complex piece of equipment and should be used only by trained personnel.

AC Power Connection: Before you plug in the game, be sure that the game's power supply can accept the AC line voltage in your location. The line voltage in your area is listed in the first chapter of this manual.

Disconnect Power During Repair: To avoid electric shock, disconnect the game from the AC power before removing or repairing any part of the game. If you remove or repair the video display, be sure you follow the correct procedure. High voltage capacitors in the video display can store a charge even after power is disconnected in the display cabinet and the cabinet is not GROUND. Do not touch any part of the display with your hands.

Use Only Approved Parts: Use only approved parts when repairing the simulator. The simulator is a complex piece of equipment and should be used only by trained personnel.

Use Only Approved Parts: Use only approved parts when repairing the simulator. The simulator is a complex piece of equipment and should be used only by trained personnel.

Chapter 4 contains the illustrated parts lists.

Safety Summary

The following safety precautions apply to all game operators and service personnel. Specific warnings and cautions will be found in this manual whenever they apply.

WARNING

Properly Ground the Game. Players may receive an electrical shock if this game is not properly grounded! To avoid electrical shock, do not plug in the game until it has been inspected and properly grounded. This game should only be plugged into a grounded three-wire outlet. If you have only a two-wire outlet, we recommend you hire a licensed electrician to install a three-wire grounded outlet. If the control panel is not properly grounded, players may receive an electrical shock! After servicing any part on the control panel, check that the grounding wire is firmly secured to the inside of the control panel. After you have checked this, lock up the game.

AC Power Connection. Before you plug in the game, be sure that the game's power supply can accept the AC line voltage in your location. The line voltage requirements are listed in the first chapter of this manual.

Disconnect Power During Repairs. To avoid electrical shock, disconnect the game from the AC power before removing or repairing any part of the game. If you remove or repair the video display, be very careful to avoid electrical shock. High voltages continue to exist even after power is disconnected in the display circuitry and the cathode-ray tube (CRT). Do not touch the internal parts of the display with your hands or with metal objects! Always discharge the high voltage from the CRT before servicing it. Do this after you disconnect it from the power source. First, attach one end of a large, well-insulated, 18-gauge jumper wire to

ground. Then momentarily touch the free end of the grounded jumper wire to the CRT anode by sliding the wire under the anode cap. Wait two minutes and do this again.

Use Only Atari Parts. To maintain the safety of your Atari game, use only Atari parts when you repair it. Using non-Atari parts or



modifying the game circuitry may be dangerous, and could injure you and your players.

Handle the CRT With Care. If you drop the CRT and it breaks, it may implode! Shattered glass from the implosion can fly six feet or more.

Use the Proper Fuses. To avoid electrical shock, use replacement fuses which are specified in the parts list for this game. Replacement fuses must match those replaced in fuse type, voltage rating, and current rating. In addition, the fuse cover must be in place during game operation.

CAUTION

Properly Attach All Connectors. Make sure that the connectors on each printed circuit board (PCB) are properly plugged in. The connectors are keyed to fit only one way. If they do not slip on easily, do not force them. If you reverse a connector, it may damage your game and void your warranty.

Ensure the Proper AC Line Frequency. Video games manufactured for operation on 60 Hz line power (used in the United States) must not be operated in countries with 50 Hz line power (used in Europe). If a 60 Hz machine operates on 50 Hz line power, the fluorescent line ballast transformer will overheat and cause a potential fire hazard. Check the product identification label on your machine for the line frequency required.

ABOUT NOTES, CAUTIONS, AND WARNINGS

In Atari publications, notes, cautions and warnings have the following meaning:

NOTE — A highlighted piece of information.

CAUTION — Equipment and/or parts can be damaged or destroyed if instructions are not followed. You will void the warranty on Atari printed-circuit boards, parts thereon, and video displays if equipment or parts are damaged or destroyed due to failure of following instructions.

WARNING — Players and/or technicians can be killed or injured if instructions are not followed.

Set-Up

HOW TO USE THIS MANUAL

This manual is written for operators and service personnel. It provides information for setting up, driving, testing, and maintaining your Race Drivin' Compact™ simulator.



the self-test. You should regularly test the boards and controls with the self-test to keep your simulator in peak condition and at top earnings.

The manual is divided into the following chapters:

- Chapter 1 contains set-up and simulator driving information.
- Chapter 2 contains self-test procedures and additional diagnostic tests. The self-test is important in the Race Drivin' compact simulator. You can troubleshoot the PC boards, main circuits, and controls using the more than 60 screens in

- Chapter 3 contains the preventive maintenance schedule for the simulator and the repair procedures, flowcharts, and troubleshooting tables for each control. If you have problems with your simulator, use this chapter to troubleshoot and to repair it. Be sure to perform the preventive maintenance tasks to keep your simulator in good condition.
- Chapter 4 contains the illustrated parts lists.

Operating the Simulator

To operate your simulator for maximum income, make sure your players know that the simulator is designed to be driven like a real car. You should regularly do the automated self-test and check the controls with the Control Inputs screen in the self-test. By using the self-test regularly, you can find and fix problems immediately. This lets you keep your simulator in top condition.

NOTE

If you are installing a new PC board or a control in your simulator, go through the Set Controls screen in the self-test. This is explained in Chapter 2.

If you turn on your simulator and you see a screen that says Initialize Pot Inputs instead of the attraction screens, then reset the controls by following the instructions on the screens that appear.

Inspecting the Simulator

WARNING

To avoid electrically shocking yourself and damaging the simulator electronics, do not plug in the simulator until it has been inspected and set up for your line voltage.

This cabinet should be connected to a grounded three-wire outlet only. If you have only two-wire outlets, we recommend that you hire a licensed electrician to install grounded outlets. Players can receive an electrical shock if the cabinet is not properly grounded. Inspect your Race Drivin' simulator carefully to ensure that the simulator is complete and was delivered to you in good condition.

Inspect the cabinet as follows:

1. Examine the exterior of the cabinet for dents, chips, or broken parts.
2. Open the service door. Unlock and open the coin doors. Inspect the interior of the cabinet as follows:
 - a. Check that all plug-in connectors on the cabinet harnesses are firmly plugged in. Do not force connectors together. The connectors are keyed so they fit only in the proper orientation. A reversed connector can damage a printed-circuit board (PCB). This will void your warranty.
 - b. Ensure that all plug-in integrated circuits on each PCB are firmly plugged into their sockets.

Table 1-1 Simulator Specifications

Characteristic	Specification
Power Consumption	300 W maximum
Line Fuse Rating	3 Amps
Line Voltage	102 to 132 VAC
Temperature	5° to 38° C (37° to 100° F)
Humidity	Not to exceed 95% relative
Width	27 1/4 in. (69 cm.)
Depth	40 in. (102 cm.)
Height	79 in. (201 cm.)
Weight	450 lbs. (204.5 kg.)

- c. Inspect the power cord for any cuts or dents in the insulation.
- d. Inspect the power supply. Make sure that the correct fuses are installed. Check that the harness is plugged in correctly and that the fuse block cover is mounted in place. Check that the green ground wires are connected.
- e. Inspect other sub-assemblies, such as the video display, controls, printed-circuit boards (PCBs), and speakers. Make sure that they are mounted securely and that the ground wires are connected.

Adjusting the Glides

After you move the simulator into location, screw out the adjustable glides in the base to support it.

Before you move the simulator, retract the glides so they are not damaged.

Control and Switch Locations

Most of the controls are located inside the seat, behind the coin door. The only exception is the power on/off switch.

Power On/Off Switch

The power on/off switch is located at the bottom rear of the cabinet.

Volume Control

The volume control is located behind the upper coin door under the seat.

Self-Test Switch

The self-test switch is located behind the upper coin door under the seat. See Chapter 2 for a complete description of the self-test.

Auxiliary Coin Switches

An auxiliary coin switch is located on the component bracket behind the upper coin door under the seat. Use the auxiliary coin switch to give players coin credits.

Coin Counter

The coin counter is located behind the upper coin door. The coin counter records the number of coins deposited. It does not count the credits given by the auxiliary coin switch.

Setting the Coin and Game Options

The Race Drivin' Compact coin and game options are set in the self-test. Refer to Chapter 2 for the recommended settings and the procedure for setting the options.

Simulator Systems

The Race Drivin' simulator uses eight PCBs to give a realistic look and feel to the driving. These PCBs are the DSK PCB, the Multisync (main) PCB, the ADSP PCB, the motor amplifier PCB, the audio and power PCB (mounted on the power supply assembly), two PCBs mounted on the steering wheel, the sound PCB, and the video display board. These PCBs control the simulator software, the video display, and the controls.

The Multisync PCB, which is the largest, holds the 68010 and the GSP microprocessor systems. The 68010 system

contains program RAM and ROM. The GSP (Graphic Systems Processor) microprocessor system controls the video RAMs (VRAMs).

The ADSP board and the sound board are mounted with the multisync main PCB. The motor amplifier PCB is mounted in a heat sink assembly located on the driver's left. It controls the steering wheel motor using the input from the two boards mounted on the steering assembly.

PCBs, and microprocessor systems. You can check all of these when you switch on the self-test. Also in the self-test you can check the video display,

Simulator Driving

This section describes the features and driving of the Race Drivin' simulator.

Introduction

Race Drivin' includes all of the innovative game features that made Hard Drivin' the industry's first true driving simulation game, plus many more new features.

New Features

Improved Handling — Faster microprocessor and more efficient software code provides a now imperceptible lag time between control input and screen graphic response. Race Drivin' feels even more like a real car!

New Tracks — The Super Stunt track will challenge even the best Hard Drivin' stunt racers. New tests of skill include a corkscrew loop, a jump loop, and a winding mountain road.

The autocross track with a built-in pace car provides feedback to hone competitive driving skills. The vector-drawn pace car is actually a recorded view of the player's best lap.

Buddy Race — Two-player sequential race in which the computer records the performance of player one, and player two races head-to-head against the first player and the clock.

Linked Race — Install a simple cable between two

Race Drivin' Compact simulator cabinets, adjust game options, and the buddy race becomes a true head-to-head competition.

Select a Car — Players can select from several dif-

ferent sports cars to suit the race track chosen. The Race Drivin' cars are modeled after the performance features of several well-known sports cars. Each car has its own handling characteristics of off-the-line quickness, top speed, and cornering.

In addition to all of the innovations aimed at the player, Atari has also included many improvements that will be appreciated by the operator.

Switch on the main power to find the source of the problem. If you are having electronic problems, you can check the state of various signals with the LEDs on the main PCB.

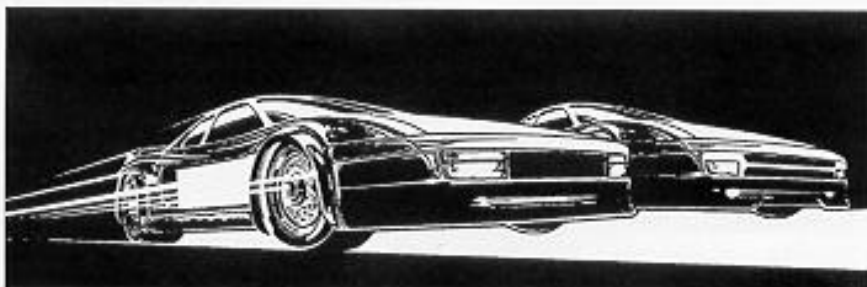

Self-Test

TESTING THE GAME

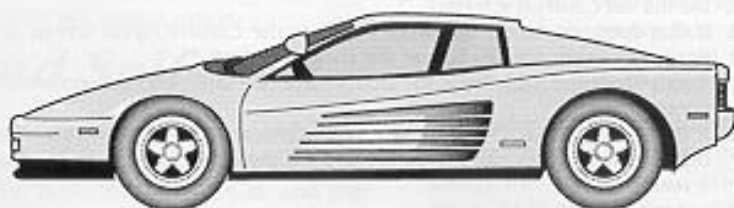

The *Race Drivin'* simulator is a com-

plex machine. To keep it at peak efficiency and maximum earnings, you should regularly check the controls, RAMs, ROMs, PCBs, and microprocessor systems. You can check all of these when you switch on the self-test. Also in the self-test you can check the video display,

the statistics, and set the internal clock.

If you cannot use the self-test because the screen is dark, you can use a DIP switch on the main PCB to find the source of the problem. If you are having electronic problems, you can check the state of various signals with the LEDs on the main PCB.

You should regularly check the following screens and information. We recommend you check these when you first set up the simulator, each time you collect money, or when the simulator is not working correctly.

- Use the automated self-test, which begins automatically when you turn on the self-test to test the program RAMs and ROMs, the video RAMs, color RAMs, the DSK PCB, the ADSP PCB, and the sound PCB. The test takes about five minutes to run.
- Check the *Control Inputs* screen, which you choose from the *Test Menu* screen. This shows the voltage input to the Multisync PCB from the steering wheel, brake pedal, gas pedal, clutch pedal, seat, and shifter. With this information you can easily check how the controls are working.

NOTE

If the control inputs are wrong, your earnings may drop, since the realistic driving feel is lost.

- Check the *Statistics*, *Histogram*, and *Games Played by Day and Hour* screens which show the statistical information about how and when your simulator is played.

Table 2-1 shows you what tests and screens to use at different times and for different problems.

Table 2-1 Using the Self-Test Screens and Diagnostics

Problem or Type	Explanation
Automated Self-Test	When you switch on the self-test, the automated self-test is performed. This tests the program RAM and ROM and the PCBs. You can skip the self-test by turning and holding the key as soon as you enter the self-test. If you cannot run the self-test at all, use the DIP switches to diagnose the problem. These are explained at the end of this chapter.
Test Menu	Appears after the automated self-test. Select tests and information on this screen.
Regular Maintenance	Regularly do the following: 1. Do the automated self-test. 2. Check the <i>Operator Screens</i> . 3. Go to the <i>Control Inputs</i> screen to test the controls.
Game Set-Up	When you first set up your game, do the following: 1. Do the automated self-test. 2. Make sure the options on the <i>Operator Screens</i> are set correctly for your location, or set to the defaults. 3. Go to the <i>Control Inputs</i> screen to test the controls. 4. Set the clock, if necessary, using the <i>Set Time</i> screen.
Control Problem	1. Do the <i>Set Controls</i> screens. 2. If that does not correct the problem, go to the <i>Control Inputs</i> screen and see if the input from the control changes as you use the control. 3. Go to Chapter 3 and check the troubleshooting table and maintenance information for that control. 4. If the shifter, brake, clutch, or seat potentiometer is broken and you cannot fix it immediately, but still want to operate the game, turn off the control circuit in the <i>Disable Broken Controls</i> screen.
Video Display Problem	1. Try the <i>Monitor Test Patterns</i> screens. 2. If you cannot go into the self-test or the screen is dark, use the DIP switch diagnostics.
Electronics Problems	1. Do the automated self-test. 2. Choose the <i>Spectral Functions</i> screen that applies to your problems: the GSP, program ROM, ADSP PC board, sound PC board, or DSK PC board test.
Game Clock	Use the <i>Set Time</i> screen to set the internal game clock. This time is used in the statistics screen that shows games played by day and time and in the schedule for clearing the high score table.
Cannot Enter the Self-Test	Use the DIP switches and the LEDs to diagnose the problem. These are explained at the end of the chapter.

Entering and Exiting the Self-Test

You enter and exit the automated self-test procedure by turning the self-test switch on or off. The switch is located at the back of the upper coin compartment. You run the tests with the door open so that you can press the right and left coin switches to move up and down the menus.

The self-test consists of:

- A five-minute automated self-test of the ROM, RAM, the microprocessor, and the PC boards
- A Test menu from which you can run specific tests in the event that you receive error messages

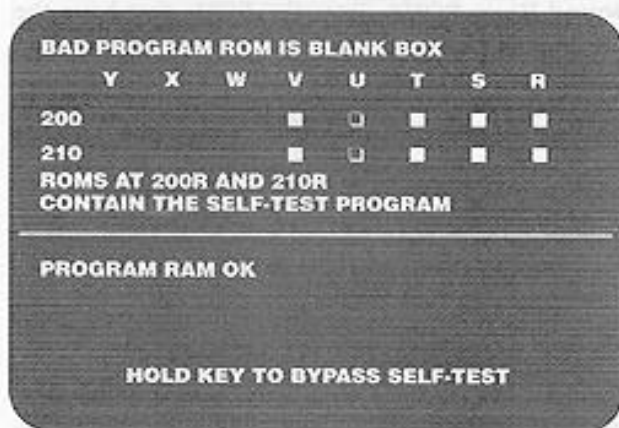

Figure 2-1 Program ROM and RAM Test Screen

If you are running a specific test and turn off the self-test switch to exit, you may need to proceed through all the screens in the submenu and return to the Test menu before you return to the attract mode.

Automated Self-Test

When you enter the self-test, the simulator automatically tests the program ROM and RAM, the video RAM, the color RAM, the DSK PCB, the ADSP PCB, and the sound PCB.

NOTE

If you do not see anything on the video display screen, you may have a video display problem or a simulator system problem. See DIP Switches at the end of this chapter to diagnose the problem.

The automated testing takes about five minutes. The results appear on the screen. Messages in red alert you to a problem. You can run further testing from the Test menu.

If you do not want to wait for the systems and PCBs to be tested, you can skip these tests by turning the ignition key while in the program ROM and RAM screen, Figure 2-1. (If the self-test proceeds beyond this screen, it will run its course.) If you want to exit to the attract mode, just turn the self-test switch off.

BAD PROGRAM ROM
PROGRAM RAM OK
GSP VRAM OK—SIMPLE TEST
GSP COLOR RAM OK
DSK BOARD OK
ADSP BOARD OK
SOUND BOARD TEST OK
SOUND WAVE ROMS OK
STEERING WHEEL MOTOR TEST OK. SIMPLE TEST.

TURN KEY TO SELECT TEST MENU

Figure 2-2 Microprocessor and Board Tests Screen

Program ROM and RAM Test

When you enter self-test, the simulator tests the program ROM and RAM. The screen in Figure 2-1 shows the results of a program ROM and RAM test.

The top of the screen shows the ROM test result. The numbers on the left and the letters on the top of the screen show the locations of the ROMs on the Multi-sync PCB. If a white box appears, then the ROM there is good. If an empty box appears (as shown at 200U and 210U), then the ROM there is bad. If nothing appears, then nothing was tested there.

The RAMs are tested after the ROMs. If the RAMs have no errors, then you see the message *Program RAM OK*. If the test finds an error, then you see *Bad Program RAM At* with the bad RAM location listed.

This screen disappears after a few seconds and the self-test continues. However, the screen with the results of the complete self-test, shown in Figure 2-2, shows the message *Bad Program ROM* (or *Bad Program RAM*) if it found an error in the program ROMs or RAMs.

Microprocessor and Board Tests

After checking the program RAM and ROM, the automated self-test checks the simulator's microprocessor and PC boards. It tests the video RAM and color RAM in the GSP microprocessor system, the DSK board, the ADSP board, and the sound board. The test takes four to five minutes. You see the screen in Figure 2-2 when the test finishes.

If the system or board is good, *OK* follows the test name. If it is bad, the word *Bad* precedes the name of the board or system (except for the ADSP board test, which gives more information). If you have a bad system or board, then choose *Special Functions* from the Test menu, choose the appropriate system or board tests from the Special Functions menu, and read the description of the tests in this chapter.

Here is a brief description of each microprocessor and board test performed during the automated self-test.

PROGRAM ROM: Described above.

USING THE TEST MENU

PRESS LEFT COIN SWITCH
TO MOVE UP OR TO INCREMENT
PRESS RIGHT COIN SWITCH
TO MOVE DOWN OR TO DECREMENT
TURN KEY TO CHOOSE ITEM
OR TO RETURN

Figure 2-3 Instructions for Test Menu Screen

```

TEST MENU
OPERATOR SCREENS
SET CONTROLS
CONTROL INPUTS
MONITOR TEST PATTERNS
SET TIME
DISABLE BROKEN CONTROLS
SPECIAL FUNCTIONS

RACE DRIVIN'
VERSION 1.7
COPYRIGHT ATARI GAMES 1988, 1989, 1990

FRIDAY           8:06:24 AM           JULY 20, 1990
  
```

Figure 2-4 Test Menu Screen

PROGRAM RAM: Described above.

GSP VRAM: Uses the Simple GSP VRAM Test. (Described in the section *Multisync Board GSP Tests*.)

GSP COLOR RAM: Uses the GSP Color RAM Test. (Described in the section *Multisync Board GSP Tests*.)

DSK Board: Tests two ASIC systems, the DSK Program RAM, the DSK ZeroPower RAM, and the DSK Program ROM. These tests are described in the section *DSK Board Tests*.

ADSP Board: Tests the ADSP board memory and the ADSP-2100. Most of the error messages are self-explanatory. (*Does Not Respond* generally indicates a missing board.)

Sound Board: Tests the sound program ROM and RAM, the sound board communications ROM and the 32010 ROM.

Sound Wave ROMS: Tests the ROMs that have the sound waveform data. If any are bad, the message *Bad Sound Wave ROMs* appears on the screen.

Steering Wheel Motor Test: Performs a simple test of the steering wheel system.

Test Menu Screens

After the microprocessor and board test is finished or you bypass it, turn the key to proceed to the Test menu. The Test menu screens let you conduct specific troubleshooting in the event of problems.

Turn the key once to see a screen that explains how to select from the Test menu, shown in Figure 2-3. Turn the key again to see the Test menu, shown in Figure 2-4.

As the screen shown in Figure 2-3 explains, you use the right and left coin switches and the ignition key to make a selection from the Test menu. Pressing the right or left coin switch on the back of the upper coin door moves you up or down the menu. When the op-

```

Coin Options
Coin Mode
3 coins 1 credit
Right Mech Multiplier
1 coin counts as 1 coin
Left Mech Multiplier
1 coin counts as 1 coin
Bonus Adder
No Bonus Adder

Hit LEFT/RIGHT coin switches to move UP/DOWN
Hold ABORT and hit coin switches to cycle through choices
Hold down ABORT and turn key to restore original setting
Just turn key to save this setting and exit
  
```

Figure 2-5 Coin Options Screen

Table 2-2 Coin Option Settings

Option	Available Settings
Coin Mode	1 coin/1 credit 2 coins/1 credit ♦ 3 coins/1 credit 4 coins/1 credit
Right Mech Multiplier	1 coin counts as 1 coin ♦ 1 coin counts as 4 coins 1 coin counts as 5 coins 1 coin counts as 6 coins
Left Mech Multiplier	1 coin counts as 1 coin ♦ 1 coin counts as 2 coins
Bonus Adder	No bonus adder ♦ 2 coins give 1 extra coin 3 coins give 1 extra coin 4 coins give 1 extra coin 4 coins give 2 extra coins 5 coins give 1 extra coin Free Play

♦ *Manufacturer's recommended settings*

tion you want is white, turn the ignition key to select it. The submenus for the specific tests work the same way.

The Test menu, shown in Figure 2-4, is the most important screen in the self-test. Use this screen to choose specific tests to pinpoint problems and to set the game options. Table 2-4 shows all the tests that are available from the Test menu.

Operator Screens

Choose Operator Screens from the menu by pressing the right or left coin switch until this item is white, then turn the ignition key to select it.

If you are in the operator screens and want to go to the attract mode, first turn the key to go through the remaining operator screens. When you return to the Test menu, turn off the self-test switch.

The Operator Screens let you set game options and monitor the use of the simulator. The choices on the Operator Screens submenu are:

- Coin Options
- Link Options
- Game Options
- Statistics
- Histograms of Game Times
- Error Count
- Games Played by Day and Hour

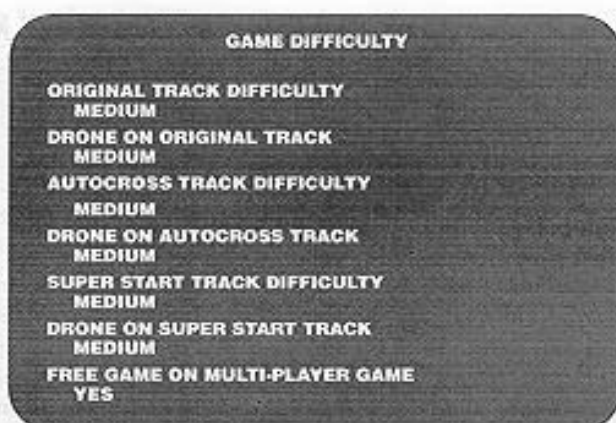

Figure 2-6 Game Difficulty

Coin Options

The first operator screen, Coin Options, lets you reset the coin credits (see Figure 2-5).

To reset the coin options:

- Move up or down the list by pressing the right or left coin switch. A blue box indicates which item is selected.
- Press the Abort button and either coin switch to scroll through the settings until you see the one you want.
- To return to the original settings, press the Abort button and turn the ignition key.
- When through, turn the key to exit the screen.

The default setting of each option is green. The available settings are listed in Table 2-2.

The Coin Options are as follows:

- *Coin Mode* is the number of coins required for one credit.

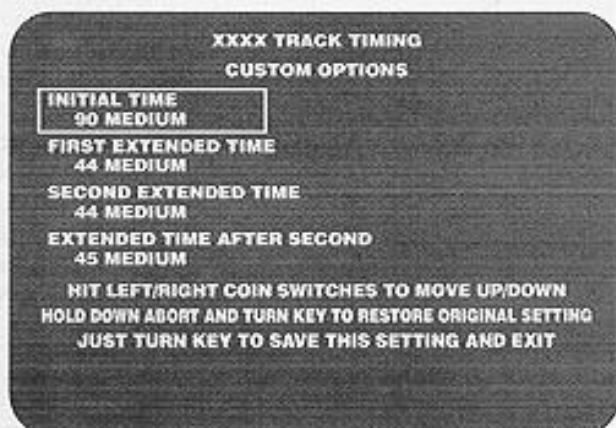

Figure 2-7 Custom Game Options Screen

Table 2-3 All Screens Appearing in the Self-Test

Screen	Use
Automated Self Test	
Program RAM and ROM	Tests the program RAM and ROM.
Automated Self-Test Results	Shows results of the program RAM and ROM, VRAM, color RAM, MSP DRAM, ADSP PCB, and sound PCB tests.
Test Menu Screens	
Instructions for Test Menu	Information about using the test menu.
Test Menu	List of available tests and information you can choose.
Operator Screens	
Coin Options	Sets the coin options.
Game Difficulty	Sets track and drone difficulty.
Track Timing	Use preset game options first.
Game Options	Sets the game options, controls the high score table and steering in the attract mode.
Statistics	Shows game statistics.
Histograms	Shows game histograms, and number of games by length of play.
Error Count	Shows the error count from the PC boards. Used by the factory for debugging.
Games Played by Day and Hour	The simulator clock must be set correctly to get maximum use from this screen.
Set Controls	
Initialize Pot Inputs	Use if you are having any control problems or replace or repair a control or a PCB. Initializes all the simulator potentiometers.
Initialize Steering Limits	Sets the steering limits.
Initialize Shifter Limits	Sets the shifter limits.
Initialize Seat Limits	Sets the seat movement limits.
Initialize Force Brake	Sets the limit on the force on the brake.
Control Inputs	Check this screen <i>regularly</i> to make sure your controls are operating correctly.
Monitor Test Patterns	
Color Bars	Use these screens to check the performance of your video display. Shows the video display colors.
Monitor Adjust	Used for the monitor setup.
Monitor Brightness	Shows the brightness adjustment.
Grey Scale	Shows the grey scale of the video display.
B/W Dots	Shows convergence and focus of the video display.
B/W Grid	Shows convergence and focus of the video display.
Diagonal Lines	Shows linearity of the video display.
Full Screen Grey	Shows the color purity of the video display.
Full Screen White	Shows the color purity of the video display.
Full Screen Red	Shows the color purity of the video display.
Full Screen Green	Shows the color purity of the video display.
Full Screen Blue	Shows the color purity of the video display.
Monitor High Voltage Test	Checks the regulation of the high voltage to the video display.
Scrolling Test	Checks the scrolling mechanism of the GSP microprocessor.
Set Clock	Set the time so that you can get maximum use from the <i>Games Played By Day and Hour</i> screen and so that the high score table reset occurs at the right time.
Disable Broken Controls	If you cannot repair a broken shifter, brake, clutch or seat potentiometer immediately, you can disable that control's circuit so you can continue to operate the game. <i>Repair the broken control as soon as possible. Use this screen only as a temporary measure.</i>

Table 2-3 All Screens Appearing in the Self-Test, Continued

Screen	Use
Special Functions	Use this screen for tests of the controls, PCBs, and microprocessors.
Multisync Board GSP Tests	Use this screen if you have a VRAM failure in the automated self-test.
VRAM Simple Test	Checks for bad VRAMs in the GSP microprocessor system.
VRAM Verify Test	Tests all the VRAM GSP memory.
VRAM Complete Test	Completely tests all VRAM.
Color RAM	Tests the color RAM.
VRAM Shift Register Test	Checks the VRAM shift register.
Multisync Board Controls	Shows much the same information as the <i>Control Inputs</i> screen, but has additional tests for the steering wheel, shifter, and line voltage calibration.
Pots: 8 Bit	Shows the gas pedal, clutch pedal, and brake force input to the Multisync PCB.
Pots: 12 Bit	Not used.
Steering Wheel	Use if the steering wheel does not work. See the steering wheel flow charts in Chapter 3 for information about their use.
Send Force	Use this test as directed in the flowchart in Chapter 3.
Sine Wave	Sends a sine wave force to the motor amplifier PCB.
Square Wave	Sends a square wave force to the motor amplifier PCB.
Triangle Wave	Use this test as directed in the flowchart in Chapter 3.
Closed Loop Test	Sends a force to the motor amplifier PCB to simulate a simple spring.
Life Test	For factory use only.
Duart	Not used.
Link Connector	Use this screen if the game link does not work correctly.
Multisync Board ROM Checksums	Use this test if the program ROMs fail the automated self-test.
Multisync Board ZRAM Tests	Check the ZRAMs. Use this if all the controls are operating erratically or the statistics are not kept correctly.
ADSP Board Tests	
ADSP RAM .TESTED BY 68010.	Use this test if the ADSP board fails the automated self-test.
ADSP PROGRAM MEMORY TEST .2100.	The 2100 runs a standard, complete test on its own program memory.
ADSP DATA MEMORY TEST .2100.	The 2100 runs a standard, complete test on its own data memory.
2100 Test	Tests the response of the 2100 integrated circuit on the ADSP PCB.
IRQ Test	Tests if the ADSP system can generate IRQs.
ROM Checksums	Tests the graphics ROMs on the ADSP PCB.
ADSP Special Functions	Performs hardware diagnosis and oscilloscope test loops for use by a repair technician.
Sound Board Tests	Use these tests if the sound board fails the automated self-test.
Sound Board Self-Test	Tests the sound program RAM and ROM, COMRAM and the 320 RAM.
Play Sounds	Choose and hear game sounds.
Sound Board ROM Checksums	Tests the sound PCB ROMs.
Sound Board Program RAMs	Tests the sound PCB program RAMs.
Sound Board Program ROMs	Tests the sound PCB program ROMs.
COMRAM	Tests the sound PCB communication ROM.
320 RAM	Tests the sound PCB 32010 program RAM.

- *Right Mech Multiplier* is the number of coins each coin counts as in the right coin mechanism.
- *Left Mech Multiplier* is the number of coins each coin counts as in the left coin mechanism.
- *Bonus Adder* lets you choose bonus coins, no bonus, or free play.

Game Difficulty

The game difficulty of each track and the difficulty of the drone car for each track can be set with this screen (Figure 2-6). In addition to settings of easy, medium, hard and very hard, custom tuning is provided. In the *Custom* setting, you can choose the actual amount of time a driver is given. You can select different times for each individual lap in this option.

The actual times for easy, medium, hard, and very hard game difficulty settings are also shown in the custom settings. For example, if you have chosen the medium setting in *Game Difficulty*, then the custom screen appears as shown in Figure 2-7.

NOTE

Always use the preset Game Difficulty settings before you use the settings of the Custom game options.

To move and choose in this screen, do the following:

- To move up or down the list, press the right or left coin switch.
- To change a setting, press the abort button and either coin switch.

Table 2-4 Game Option Settings

Option	Available Settings	
Champ Lap Qualification	Easy	Medium ♦
	Hard	Very Hard
Steering During Attract Mode	On ♦	Off
Steering Wheel Force	Very Light	Light
	Medium ♦	Stiff
High Score Name Censor	Easygoing ♦	Strict
Clear High Score Table	Don't Clear	
	Clear Now	
	Clear Every Week ♦	
	Clear Every 2 Weeks	
Signs and Gauges	Miles per Hour ♦	
	Kilometers per Hour	
Game Type	Available Soon	

♦ *Manufacturer's recommended settings*

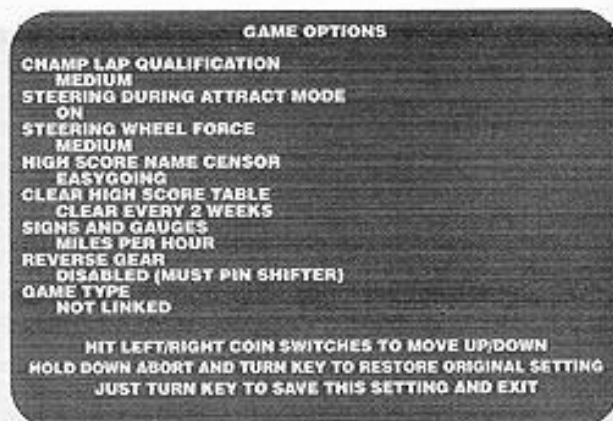

Figure 2-8 Game Options Screen

- To return to the setting that was originally on the screen, press the abort button and turn the key.
- To exit the screen, turn the key.

You can change an option when it is inside the blue box. The default setting of each option is green. The other settings are blue when the option is selected. (The other settings are white when the option is *not* selected.)

The custom game options are explained below.

- *Initial Time* is the amount of time always given for one driving session.
- *First Extended Time* is the amount of time given if the driver crosses the finish line before the initial time is up.
- *Second Extended Time* is the amount of time given if the driver crosses the finish line before the time is up on his second lap.
- *Extended Time After Second* is the amount of time given when the driver crosses the finish line before the time is up after the first two laps.

Game Options

Use the Game Options screen to set the game difficulty and the operator options as explained below. The screen is shown in Figure 2-8.

You operate this screen the same as Coin Options. Press the coin switch to select an option, and press Abort and a coin switch to scroll to the setting you want. Turn the key to save the settings and exit. A list of the available settings is shown in Table 2-4.

The Game Options available on this screen set the following:

- *Game Difficulty* sets the game difficulty for the drivers. The settings are shown in Table 2-4. The *custom* setting lets you choose the actual amount

of time the players receive. We suggest you use the preset factory setting (easy, medium, hard, and very hard), not the custom setting.

- *Champ Lap Qualification* sets the difficulty of qualifying for the championship lap.
- *Steering During Attract Mode* allows you turn the movement of the steering wheel on or off while the simulator is in the attract mode.
- *Steering Wheel Force* is the amount of force exerted by the steering assembly motor on the steering wheel.
- *High Score Name Censor* controls a program to censor names entered on the high score table. The program deletes letters in possibly objectionable words in the high score table.
- *Clear High Score Table* clears the high score table at the time chosen. You can choose not to clear the table, clear it now, clear every week, or clear every two weeks. If you choose clear every week or clear every two weeks, the table is cleared when the simulator is turned on after Wednesday midnight every week or every second week. Be sure your simulator clock is set correctly so the table clears at the right time.
- *Signs and Gauges* allows you to choose whether the signs and gauges are displayed in kilometers or miles.

Statistics

The statistics screen is shown in Figure 2-9. The statistics are collected from the last time the statistics screen was cleared. Write this information on the statistics sheet in the back of this manual to help you maximize your profit.

To move to the next screen, just turn the key. To clear the statistics, press and hold the abort button and turn the key at the same time.

The statistics the simulator collects are explained below.

- *Left Coins* shows the number of coins counted in the left coin mechanism.
- *Right Coins* shows the number of coins counted in the right coin mechanism.
- *Aux Coins* shows the number of times the auxiliary coin switch (inside the coin door) is pressed.
- *Idle Mins* shows the number of minutes the simulator has been idle.
- *Active Mins* shows the number of minutes the simulator has been played.
- *Error Count* shows the number of errors counted in the erasable memory. If you have more than 75, check

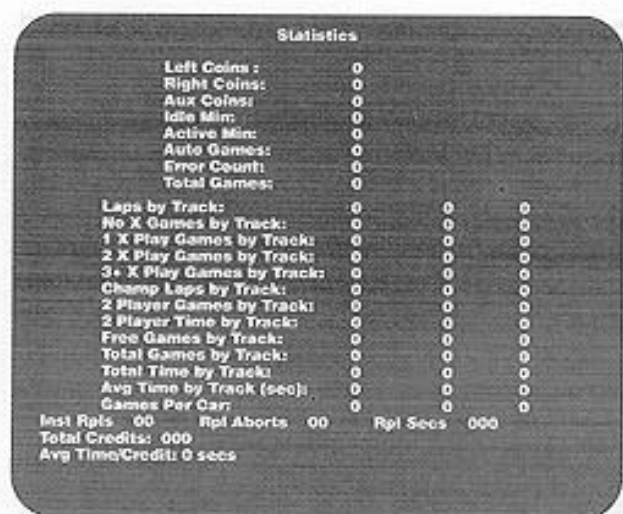

Figure 2-9 Statistics Screen

the ZRAMs with the self-test. Your simulator may need service.

- *Total Games* shows the number of unique games played.

Bottom Half of Screen

For the remaining statistics (except for the five entries at the very bottom of the screen), the three numbers after each entry represent, from left to right: first — original track at the beginning, second — autocross track, and third — super stunt track.

- *Laps by Track* is numbers of laps, completed or not, on each track.
- *No X Games by Track* is the number of times the drivers did not get extended games on either track. If the numbers are very high, then the game difficulty may be too hard.
- *1, 2, and 3+ X Play Games by Track* is the number of additional laps given to drivers if they complete the track before the time allotted. These additional laps do not need to be completed to be counted.
- *Champ Laps* is the number of times drivers qualified to race a championship lap.
- *2 Player Games by Track* is the number of games played with two players.
- *2 Player Time by Track* is the average time of all games played with two players.
- *Free Games by Track* is the number of free games played on each track.
- *Total Games by Track* shows the number of unique games for each track, regardless of how many additional laps each driver received.

Figure 2-13 Control Inputs Screen

- **Total Time by Track** shows the total time of all games for each track.
- **Avg Time by Track (sec)** shows the average total time of all games for each track.
- **Games by Car** shows the number of games played with each type of car.
- **Inst Rpls** is the total number of instant replays.
- **Rpl Abort** is the times the drivers pressed the abort button to cut the instant replay short.
- **Rpl Secs** is the total seconds the simulator is in the replay mode.
- **Total Credits** is calculated by multiplying the coins by the credit setting you chose in Coin Mode.
- **Avg Time Per Credit** is the average amount of time in seconds that each credit gave.

Histogram

The histogram screen shows the length of driving time in seconds and the how many times the simulator was driven. The screen is shown in Figure 2-10. Write these numbers on the statistics sheet in the back of this manual to help you maximize your profit.

To move to the next screen, turn the key. To clear the histograms, press and hold the abort button and turn the key at the same time.

Error Count

This screen shows the error count on the PC boards. If you call Atari Game Customer Service, the numbers on this screen may help Customer Service personnel troubleshoot your problem.

Games Played By Day and Hour

This screen, illustrated in Figure 2-11, shows the number of games played every hour in each day. The information on this screen relies on the simulator clock being set correctly. (The clock time is shown on the bottom of the Test menu screen. If the time is incorrect, follow the instructions in the *Set Clock* section of this chapter to set the clock.)

Write the simulator driving information on the statistics sheet in the back of this manual to help you maximize your profit.

To clear the screen, press and hold the abort button and turn the key at the same time.

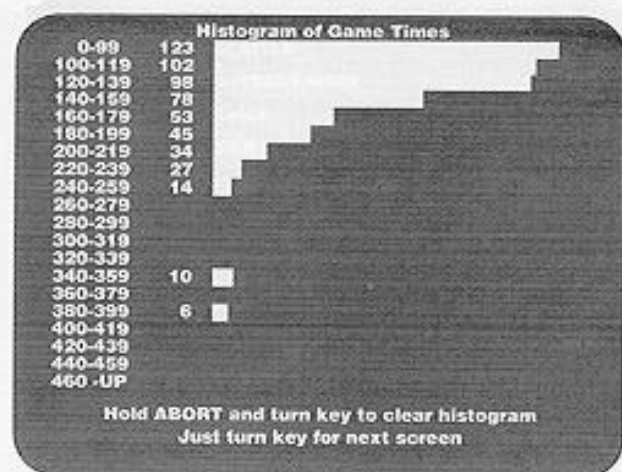

Figure 2-10 Histogram Screen

Set Controls Screens

If you have problems with the brake, clutch, gas pedal or steering assembly use the *Set Controls* screens before doing any troubleshooting or repairs. These screens allow you to set the beginning and ending points of the control input to the Multisync PCB. Often, resetting these points solves the problem you have. If resetting does not solve the problem, then check the *Control Inputs* screen, described below.

NOTE

The simulator must be on for at least 15 minutes before you use the Set Controls screen. If you do not wait this long, the brake may not initialize correctly.

If you repair a control, install a new board, or install a new control, go through the *Set Control* screens.

The first screen of the *Set Controls* screens is shown in Figure 2-12.

NOTE

If you take a control out of the simulator for or repair it, go through all the Set Controls screens after you replace it. If you do not, the simulator will not operate correctly.

After you choose *Set Controls*, simply do what the screens say. You must reset all the controls after you start the screens. The first screen initializes all potentiometers in the simulator. The next screens initialize the limits for the steering assembly, and the gas, clutch, and brake pedals. The numbers on each screen are for factory use.

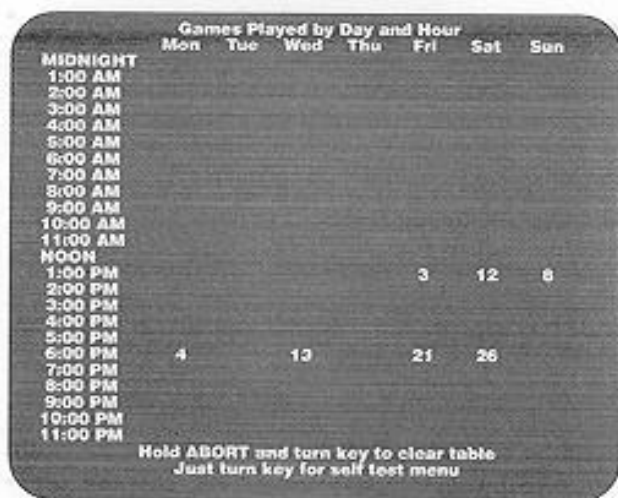

Figure 2-11 Games Played by Day and Hour Screen

NOTE

When you initialize the brake, the instructions say to "step firmly" on the brake. Do not stomp on the brake or gently press it. Either way sets the brake limits incorrectly, and drivers will be frustrated when they use the brake.

Control Inputs Screen

Check this screen as part of your regular maintenance to be sure your controls are operating correctly. The *Control Inputs* screen is shown in Figure 2-13.

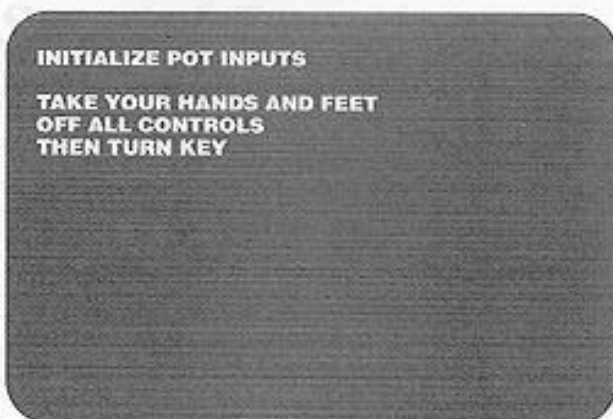

Figure 2-12 First Set Controls Screen

If you have a problem with a control, first go through the *Set Controls* screens then check the results on this screen. If using the *Set Controls* screens does not solve the problem, check Chapter 3 for troubleshooting and repair information about the control.

The following controls are checked on this screen.

- The *gas pedal* and the *clutch pedal* lines show the voltage input from the pedal potentiometers to the A/D converter circuits on the Multisync PC board. As you use a pedal, the line length on the screen changes, showing the change in the voltage input from the potentiometer.
- The *brake force* line measures the force with which you press the brake, not the distance it moves. As you press harder on the brake, the line becomes shorter, showing the change in the voltage input from the strain gauge on the pedal. To get correct results for the brake force, the simulator must be on for at least 10 minutes.

When the line is shortest, the input is 0 Volts. When it is longest, the input is 5 Volts. If the line length for the gas, brake, or clutch does not change, you have a problem with pedal. See Chapter 3.

- The *left and right coin mechanisms*, the *auxiliary coin switch*, and the *abort switch* are at the bottom of the screen. As you use the switches, the name of the part should change from blue to green. If it does not, check the switch, mechanism, and harness.
- The *shifter* checks the switch at each gear position. Move the shifter into each gear, and the shifter position number should change from blue to green. If it does not, see Chapter 3 for troubleshooting and maintenance information.
- As you turn the *steering wheel* clockwise, the hexadecimal number should increase and change to

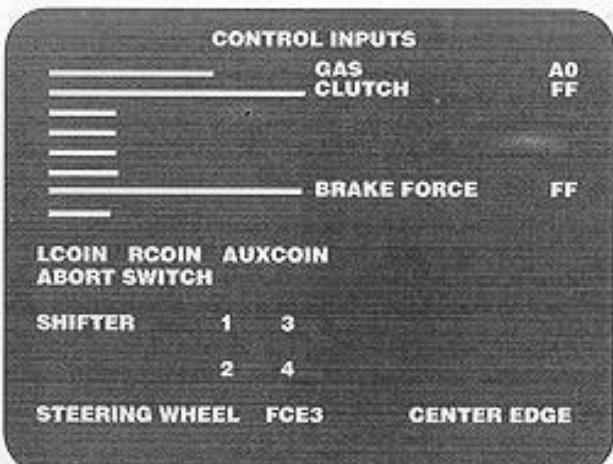

Figure 2-13 Control Inputs Screen

zero once every turn. As you turn the wheel counterclockwise, the number should decrease. Every time the steering wheel passes the center position, the words *center edge* should change from blue to green.

If the *steering wheel* numbers do not change or the words *center edge* never change to green, see the table *Troubleshooting the Steering Assembly* in Chapter 3 for more information.

Monitor Test Patterns

Use this item to see the fourteen screens for checking the video display, the color RAMs, the GSP, which controls the video RAMs (VRAMs), and the video output. To move through the screens, press the coin switches.

- *Color Bars* screen shows these colors from left to right: white, yellow, light blue, green, purple, red, blue, and grey. If the colors are incorrect, see your video display manual for adjustment procedures.
- *Monitor Adjust* is used to set up the monitor.
- *Monitor Brightness* checks the adjustment of the video display brightness.
- *Grey Scale* screen shows a white line on the left, and a grey scale showing black on the left.
- *B/W Dots* screen can be used to check convergence and focus.
- *B/W Grid* screen, shows a black background and a white grid pattern to check convergence. The grid lines should be straight within 3.0 mm. If you need to adjust the convergence, see the video display manual included with the simulator.
- *Diagonal Lines* screen can be used to check video display linearity.
- *Full Screen* colors test the color purity of the color RAMs and the display. The test displays a grey, white, red, green, and then blue screen. Each screen should be a rectangle of color, with no curving at the corners and no lines in the raster. If it does not, see your video display manual included with the simulator for adjustment procedures.
- *Monitor High Voltage Test* screens switch between a white screen and a grey screen. If the high voltage to the display is regulated properly, the sides of the screen will fluctuate about 3/4 inch from the white to the grey screen.
- *Scrolling Test* screen checks the scrolling mechanism in the GSP.

Set Clock Screen

Choose this item if you want to set the clock, turn the clock on, or turn it off. The clock should be set correctly so the statistics on the operator screen *Games Played by Day and Time* will be right.

The time on the clock also determines when the high score table is cleared. If you set the *Clear High Score Table* option in the *Game Options* screen to clear every week or every other week, then the high score table is cleared the first time the simulator is turned on after Wednesday midnight.

You may need to turn on the clock if the simulator has a program crash. Turn off the clock only if you plan to store the simulator more than six months. (The clock has a lithium battery that should last more than five years in normal use.)

To turn off the clock, choose *Clock Off* from the clock submenu, shown in Figure 2-14. To turn on the clock, choose *Start Clock* from the menu. In about two seconds, the clock starts.

If the clock is losing or gaining time, then use *Clock Faster* or *Clock Slower* to adjust the calibration of the clock.

Choose the item you need from the menu by using either coin switch. Change the setting by turning the key until you see the correct time.

The items on the clock menu are explained below.

- *Exit* returns you to the Test menu.
- *Inc Hours* changes the hour setting ahead.
- *Inc Minutes* changes the minute setting ahead.
- *Inc Seconds* changes the second setting ahead.
- *Inc Day* changes the day of the week (for example Monday or Tuesday) setting ahead.
- *Inc Month* changes the month setting ahead.

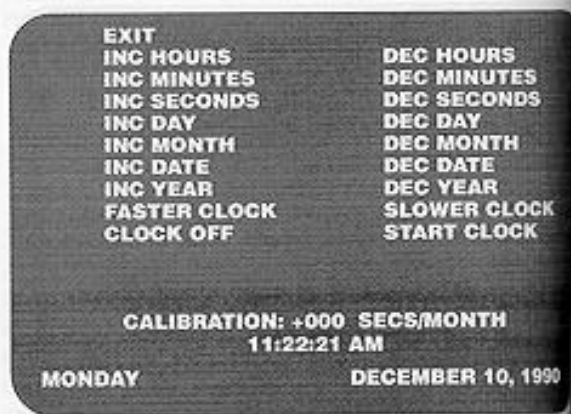

Figure 2-14 Set Clock Screen

- *Inc Date* changes the date setting ahead.
- *Inc Year* changes the year setting ahead.
- *Faster Clock* changes the calibration setting ahead. Each increase in the calibration setting makes the clock run about 5 seconds faster per month.
- *Clock Off* turns the clock off.
- *Dec Hours* changes the hour setting back.
- *Dec Minutes* changes the minute setting back.
- *Dec Seconds* changes the second setting back.
- *Dec Day* changes the day of the week (for example, Monday or Tuesday) setting back.
- *Dec Month* changes the month setting back.
- *Dec Date* changes the date setting back.
- *Dec Year* changes the year setting back.
- *Slower Clock* changes the calibration setting back. Each decrease in the calibration setting makes the clock run about 5 seconds slower per month.
- *Start Clock* starts the clock.

Disable Broken Controls Screen

Use this screen, shown in Figure 2-15, if you have a broken shifter, brake pedal, or clutch pedal, and cannot repair it immediately. Before you use this screen use the *Set Controls* screens and read the information about the control in Chapter 3.

Disable these controls *only* as a *temporary* measure so you can continue to operate the simulator. If you disable a control, the realistic driving feel of that control is lost. *Earnings could drop.*

If you have disabled a control, remember to choose *working* after you repair it.

Special Functions Screens

Use the items on this screen, shown in Figure 2-16, if a system or board failed the program RAM and ROM test or the board and microprocessor test in the automated self-test. Also use this screen if you have problems with the steering wheel, the shifter, or if the clock settings or the statistics are erratic. A short summary of when to use these items is shown in Table 2-5.

The *Special Functions* items are explained below.

- *Exit* returns you to the Test menu.

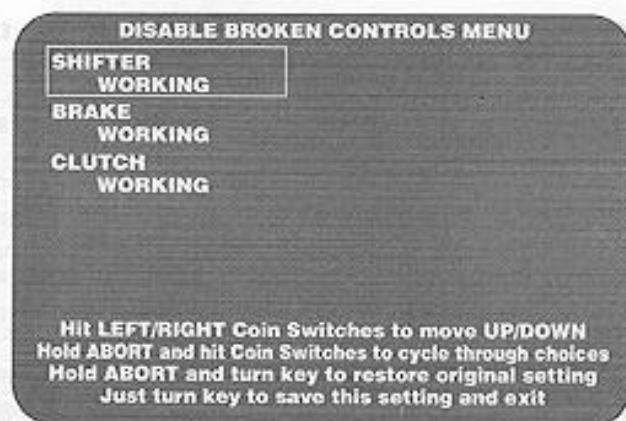

Figure 2-15 Disable Broken Controls Screen

- *Multisync Board GSP Tests* should be used if you get the message *Bad GSP VRAM* or *Bad GSP Color RAM* in the automated self-test. This screen has six tests you can use.
- *Multisync Board Controls* gives you most of the same information as provided in the *Control Inputs* screen plus five steering wheel tests, a line voltage calibration screen, additional shifter tests, and a link connect test. (All controls are "Multisync board" controls.)
- *Multisync Board ROM Checksums* should be used if you get the message *Bad Program ROM* in the automated self-test. This tests the program ROMs individually and shows the results on the screen.
- *Multisync Board ZRAM Tests* should be used if your controls settings are changing or erratic even though you used the *Set Controls* screen. Also use these tests if you suspect the simulator is not keeping the statistics correctly.



Figure 2-16 Special Functions Screen

Table 2-5 When to Use the Special Function Items

Item	When to Use
Multisync Board GSP Tests	If you see the message <i>Bad GSP VRAM</i> or <i>Bad GSP Color RAM</i> in the automated self-test.
Multisync Board Controls	If you have control problems and/or game link problems.
Multisync Board ROM Checksums	If you see the message <i>Bad Program ROM</i> in the automated self-test.
Multisync Board ZRAM Tests	If your controls settings are changing even though you have used the <i>Set Controls</i> screen or if the statistics are not being kept correctly.
ADSP Board Tests	If you see any message other than <i>ADSP Board OK</i> for the ADSP PC board test in the automated self-test.
Sound Board Tests	If you see the message <i>Bad Sound Board</i> in the automated self-test.
DSK Board Tests	If you see the message <i>Bad DSK Board</i> in the automated self-test.

- **ADSP Board Tests** should be used if you get any message other than *ADSP Board OK* for the ADSP board test in the automated self-test. This screen has three tests and an ADSP ROM checksum test. It also has eight "scope loop" tests for factory use only since they require schematics and an oscilloscope.
- **Sound Board Tests** should be used if you get the message *Bad Sound Board* in the automated self-test. However, many of the sound board tests are for factory use only since they require schematics and an oscilloscope.
- **DSK Board Tests** should be used if you get the message *Bad DSK Board* in the automated self-test. This screen allows you to test the DSK ROMs, the DSK RAM, the DSK ZeroPower RAM (ZRAM), and the two ASIC subsystems. It also has a Special Functions screen for factory quality assurance.

Multisync Board GSP Tests

If the automated self-test reports bad VRAMs, choose *Multisync Board GSP Tests* and the screen in Figure 2-16 appears.

First run the VRAM simple test. It gives the location of the bad VRAMs. If the VRAMs pass this test, but you think the simulator has a bad VRAM, run the VRAM verify test.

- **VRAM Simple Test** is the same test that is run in the automated self-test. It is run by the 68010 through the GSP interface and detects open or shorted address or data lines or missing parts. The results are displayed on-screen with a picture showing the VRAM section of the Multisync PC board. The good parts are shown in green and the bad parts are shown in red. If an entire section appears in red, the problem may be with a buffer associated with that section. The test takes about 30 seconds.
- **VRAM Verify Test** is a complete memory test run by the GSP. The results are reported on the screen like

in the simple test. The test takes about three minutes to run.

Since the verify test is run by the GSP program in the VRAMs, a single bad VRAM can cause the GSP program to crash. When this happens, the 68010 microprocessor reports that all the VRAMs are bad, although probably only one VRAM is bad. You must run the VRAM complete test (described below) to find out which VRAM is bad.

If the VRAM verify test fails, but the VRAM simple test shows the VRAMs are good, you should run the VRAM complete test.

If the verify test runs and reports that the VRAMs are good, then the VRAMs should be good.

- **VRAM Complete Test** is a complete memory test run by the 68010 through the GSP interface. Because the 68010 runs the test, a single bad VRAM does not cause the test to report all the VRAMs are bad (as it does the verify test).

Any VRAMs that are bad are shown on the screen at the end of the test. This test takes at least 22 minutes to run.

EXIT
VRAM SIMPLE TEST: 35 SECONDS
VRAM VERIFY TEST: 3 MINUTES
VRAM COMPLETE TEST: 22 MINUTES
TEST VRAM FOR DISPLAY ERRORS
COLOR RAM
VRAM SHIFT REGISTER TEST
VRAM SHIFT

Figure 2-17 GSP Tests Screen

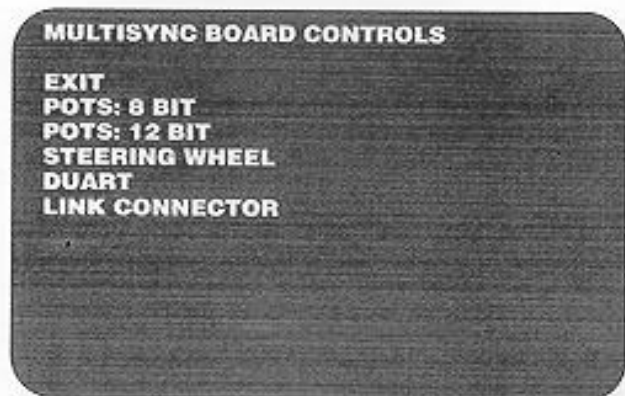

Figure 2-18 Multisync Board Controls Screen

- *Test VRAM for Display Errors* checks for video display problems.
- *Color RAM* is the same test that is performed in the automated self-test. It tests the color RAM and reports the results.
- *VRAM Shift Register Test* checks the shift register part of the video RAMs.

Multisync Board Controls

This screen provides more information about the controls than is shown in the *Control Inputs* screen. The items on the screen are described below and shown in Figure 2-18. After you choose any item on this screen and go to that item, you can return to this screen by turning the key.

- The *Pots: 8 Bit* screen has the same information as the *Control Inputs* screen. This screen appears in Figure 2-19. It shows the voltage inputs from the control potentiometers to the A/D converter circuits. As you use a control, the line on the screen changes as the voltage input changes. If the line does not change, see the information about that control in Chapter 3.

The *Brake Force* line shows the force on the brake pedal. As you push harder and harder on the brake, the line should disappear.

0 Volts appears as no line or a short line on the screen, and 5 Volts appears as a line halfway across the screen.

- *Pots: 12-Bit* screen is not used.
- *Steering Wheel* screen submenu is explained below and shown in Figure 2-20.
- *Duart* does not apply to this simulator.
- *Link Connector* tests the RS232 channel used to link two simulators together.

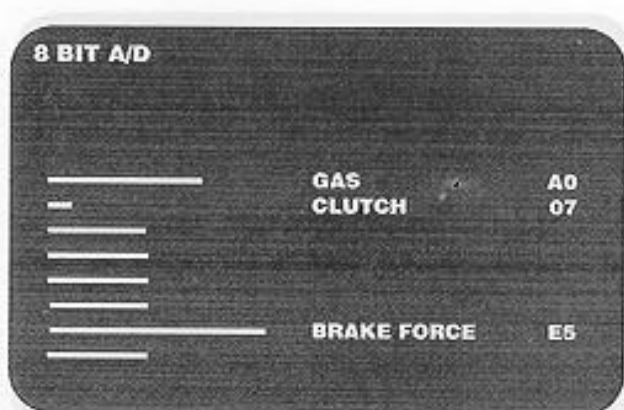

Figure 2-19 Pots: 8-Bit Screen

Steering Wheel Submenu

Use these items if you have a problem with the steering assembly. The screen is shown in Figure 2-20. You will need to read the section *Steering Assembly* in Chapter 3 to find out how to use the tests.

To move through the menu and the screens, use the coin switches. To exit a screen, push both coin switches down.

- *Exit* returns to the *Multisync Board Controls* screen.
- *Send Force* sends a steady force to the motor amplifier PCB. See Figure 2-21.
- *Sine Wave* sends a sine wave force to the motor amplifier PCB. This screen is similar to Figure 2-21.
- *Square Wave* sends a square wave force to the motor amplifier PCB. This screen is similar to Figure 2-21.
- *Triangle Wave* sends a triangle wave force to the motor amplifier PCB. This screen is similar to Figure 2-21.

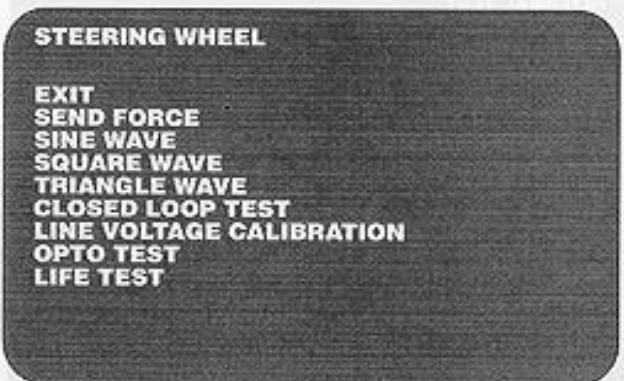

Figure 2-20 Steering Wheel Submenu Screen

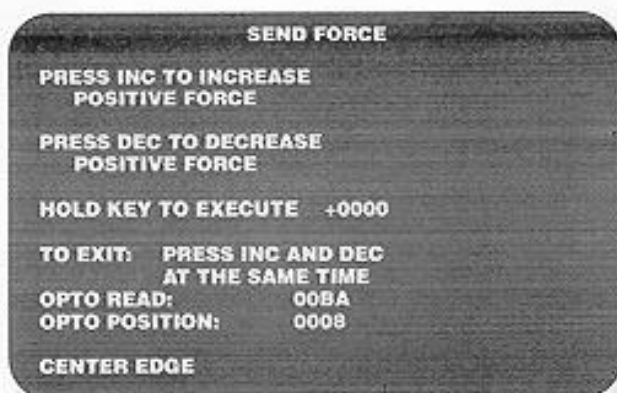

Figure 2-21 Send Force Screen

- *Closed Loop Test* reads the steering wheel position and sends a force to the motor amplifier PCB to simulate a simple spring.
- *Life Test* is a test for factory use only.

CAUTION

Do not use the Life Test. It is used only in the factory for testing of potentiometers. If you leave the simulator in this test for a long time, you can destroy the potentiometer on the steering assembly.

Link Connector Test

Use this test if you have a problem when linking two simulators together. This test requires a special test connector plugged into the Link Connector on the game.

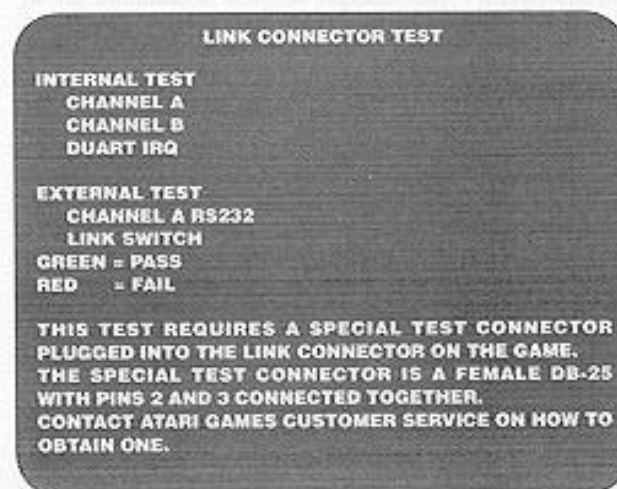

Figure 2-22 Link Connector Test Screen

The special test connector is a female DB-25 with pins 2 and 3 connected together. Contact Atari Games Customer Service on how to obtain a test connector.

The test results are displayed (in color) as shown in Figure 2-22.

Multisync Board ROM Checksums

This screen checks the Multisync PC board program ROMs for errors. Use this test if you have a bad program ROM message in the automated self-test or you suspect program ROM failure. To exit this screen, turn the key.

When the checksum test is complete, a hexadecimal number follows each ROM as shown in Figure 2-22. The first two digits in each hexadecimal number can be any number, but the last two digits must be the ones shown in Figure 2-23.

Multisync Board ZRAM Test

This test checks the non-volatile RAM where the simulator statistics and control set-up values are kept. Check the ZRAMs if you think the statistics are incorrect. Also use this test if the control settings are changing, even though you have recently set them with the *Set Controls* screens.

If the simulator loses power or is reset while it is in this test, then the statistics and the control settings will be lost. If this happens, use the *Set Controls* item from the Multisync menu to reset the controls. The statistics cannot be restored.

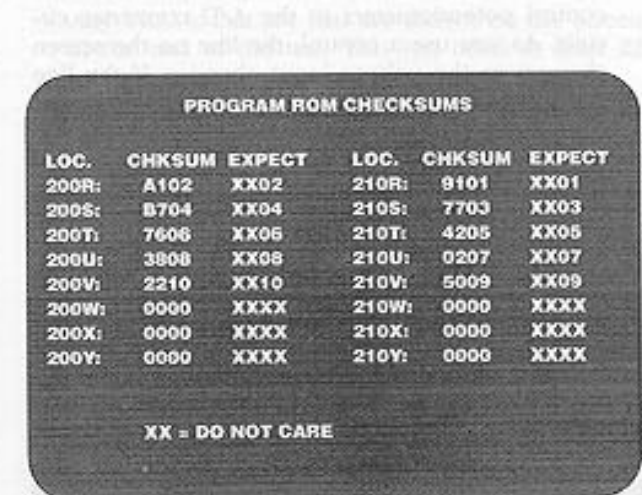

Figure 2-23 ROM Checksums Screen

ADSP Board Tests

Use this item if the ADSP PC board fails the microprocessor and board tests performed in the automated self-test.

When you select *ADSP Board Tests* from the Test menu, the screen in Figure 2-24 appears. The items on the screen are explained below.

- *Exit* returns to the Test menu.
- *ADSP RAM Tested by 68010* tests the memory on the ADSP PC board. The 68010 on the Multisync PCB test the ADSP program memory, the ADSP data memory, and both ADSP output buffers. The memory tests are the standard, complete tests but are run at the 68010's bus speed, which is slower than that of the 2100.
- *ADSP Program Memory Test .2100.* is a standard, complete memory test run by the 2100 on its own program memory. Since the test program must reside in memory, a bad program RAM may prevent the test from running. However, because the program memory is divided into two banks, the test is divided into two parts.

The program to test the upper bank is run from the lower bank; the program to test the lower bank is run from the upper bank. Unfortunately, the 2100 always starts operating from a specific address in the lower bank. Therefore, the lower bank must be operating to the extent that it can execute a JUMP instruction to the upper bank.

These tests operate solely with program memory; they do not require that any data memory be operational.

- *ADSP Data Memory Test* is a standard, complete test run by the 2100. It operates solely with program memory and does not require that any data memory be functional.
- *2100 Test* checks the response of the 2100 integrated circuit on the ADSP PC board by copying data from one location to another using a 2100 program.
- *IRQ Test* checks if the ADSP can generate interrupts for the 68010.
- *ROM Checksums* tests the graphic ROMs on the ADSP PC board. When the checksum test is complete a hexadecimal number follows each ROM as shown in Figure 2-25. The first two digits in each hexadecimal number can be any number, but the last two digits must be the ones shown in Figure 2-25. If the last two numbers are different, then the ROM is bad or it is not on the board.
- *ADSP Special Functions* performs hardware diagnosis for use by a repair technician.

ADSP BOARD TESTS

EXIT
 ADSP RAM - TESTED BY 68010.
 ADSP PROGRAM MEMORY TEST .2100.
 ADSP DATA MEMORY TEST .2100.
 2100 TEST
 IRQ TEST
 ROM CHECKSUMS
 ADSP SPECIAL FUNCTIONS

Figure 2-24 ADSP Board Tests Screen

Sound Board

Use these tests if the sound PC board failed the microprocessor and board tests in the automated self-test.

If the sound PC board failed the test, select this item from the Test menu and Figure 2-26 appears. Many of the tests require an oscilloscope and schematics. These are indicated on the list below. The tests are explained below.

- *Exit* returns to the Test menu.
- *Play Sounds* takes you to the *Requesting Sound Screen*. Follow the instructions on the screen to hear the simulator sounds.
- *Self-Test* checks the sound program ROM and RAM, COMRAM, and 320 RAM.
- *SD ROM Checksums* tests the ROMs holding the waveform data. The screen appears in Figure 2-27. It shows the ROM location, a hexadecimal number, and the results of the test for each ROM. The result will be one of the following:
 - NI*—Nothing is loaded in that socket. No action is required.
 - BAD*—The ROM is bad.
 - OK*—The ROM is OK.
 - PROG DEV*—The ROM is a program development ROM.
- *320 Sweep*—Runs a program in the sound PC board 32010 to generate a sine wave sweep from 20 Hz to 9 KHz (requires oscilloscope).
- *320 Tune*—Runs a program in the sound PC board 32010 to play a tune.
- *Program ROM*—Tests the sound PC board program ROMs with the sound PC board 68000 and reports the results on the screen.

ADSP ROM CHECKSUMS				
ADSP II	CHKSUM	EXPECT		DRIVER ADSP
9K:	0000	XXXX	.2L.	NONE
9/10K:	7423	XX23	.0L.	10K
10K:	A924	XX24	.1L.	10L
9H:	0000	XXXX	.2H.	NONE
9/10H:	9021	XX21	.0H.	10H
10H:	0022	XX22	.1H.	10J

XX = DO NOT CARE

Figure 2-25 ADSP ROM Checksums Tests Screen

Program RAM—Tests the sound PC board program RAMs with the sound PC board 68000 and reports the results on the screen.

COMRAM—Tests the sound PC board communications RAM with the sound PC board 32010 and reports the results on the screen.

320 RAM—Tests the sound PC board 32010 program RAM with the sound PC board 68000 and reports the results on the screen.

LED Test—Flashes the Test LED with the sound PC board 68000.

DAC Ramp—Writes to every DAC value with the sound PC board 68000. The sawtooth frequency is about 60 Hz (requires oscilloscope).

DAC 250 Hz—Writes to every fourth DAC value with the sound PC board 68000. The sawtooth frequency is about 250 Hz (requires oscilloscope).

SOUND BOARD TESTS	
EXIT	LED TEST
SELF-TEST	DAC RAMP
SD ROM CHECKSUMS	DAC 250 HZ
PLAY SOUNDS	SA COUNTER
320 SWEEP	SB LATCH
320 TUNE	320 TONE
PROGRAM ROM	320 IRQ
PROGRAM RAM	320 DAC RAMP
COMRAM	320 DAC ONES
320 RAM	320 SBLOCK

SOUND SOFTWARE VERSION 3.0

Figure 2-26 Sound Board Tests Screen

SA Counter—Creates an oscilloscope loop for the sound address counter (requires oscilloscope).

SB Latch—Creates an oscilloscope loop for the sound block latch (requires oscilloscope).

320 Tone—Plays a sine wave tone created by the 32010 (requires oscilloscope).

320 IRQ—Generates interrupts with the 32010 which the 68000 on the sound board recognizes (requires oscilloscope).

320 DAC Ramp—The sound PC board 32010 ramps the DAC (requires oscilloscope).

320 DAC Ones—The sound PC board 32010 writes walking ones through the DAC latch (requires oscilloscope).

320 SBLOCK—The sound PC board 32010 writes increasing addresses to the Sound Block Latch (requires oscilloscope).

DSK Board Tests

The DSK board is part of the Driver Speed Kit and turbocharges the simulator. The DSK board features:

- extra RAM for storing player races
- extra non-volatile RAM for remembering the Championship Lap
- extra ROM
- two separate ASIC systems for increasing the performance level of the simulator

The DSK Board Test screen is shown in Figure 2-28.

- **DSK ROM Checksums** tests the ROMs on the DSK board.
- **DSK ZRAM** test the additional non-volatile RAM used for storing the race of the Challenge Lap champion.

SOUND BOARD TESTS		
SOUND WAVE ROM CHECKSUMS		
65A	FFFF	NL
55A	1FC2	OK
45A	FB00	OK
30A	4313	OK
20A	5190	OK
5A	1F88	OK
65C	FD29	NL
55C	DFC0	OK
45C	313B	OK
30C	6A35	OK
20C	FFFF	NL
5C	76CB	PROG DEV

Figure 2-27 Sound Board Sound Wave ROM Checksums

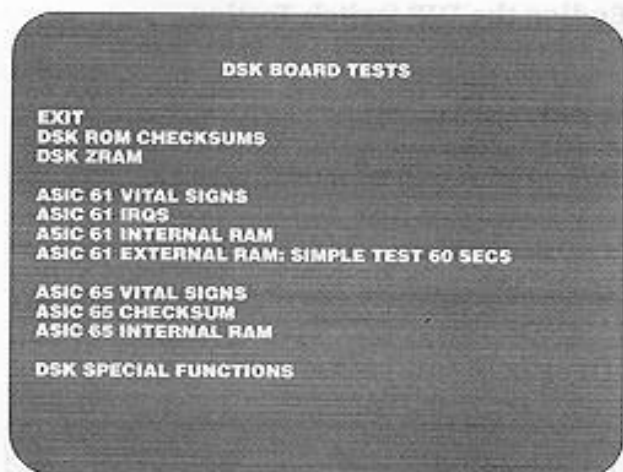

Figure 2-28 DSK Board Test Screen

The remaining tests on the menu (ASIC 61xxxx, ASIC 65xxxx, and DSK Special Functions) are used by the factory for quality testing.

LEDs on the Multisync PCB

The LEDs (light-emitting diodes) on the Multisync PCB show you the status of various signals on the Multisync PCB. Using the LEDs, you can check signals from

various circuits going to the 68010 processor. The state of the signals is indicated by the LEDs which flash or stay lit.

Figure 2-29 shows the location of the LEDs on the Multisync PCB. Table 2-6 shows the possible status of the LEDs, with an explanation of what they indicate.

DIP Switches

If you try to enter the self-test, but nothing appears on the screen, use the DIP switch tests. Use the information from these diagnostic tests to help you find the problem.

Before you begin with these following tests, be sure that the problem is in the simulator hardware, not in the video display. If you have a completely dark screen, check the following:

- Do you have power to the video display?
- Are the video display's filaments lit?
- Do you have high voltage to the video display?

If the answer to any of these questions is no, then you have a problem in the video display. Check the video display service manual included with your simulator for suggested procedure.

If you are sure that the problem is not with the video display, then try the DIP switch diagnostics shown in Table 2-8. These tests isolate various ICs and systems for troubleshooting. The results of the tests are indicated by the Multisync PC board LEDs or on the video display screen.

Table 2-6 LED Status

LED	Indicates	Status
Run LED	State of 68010 HALT signal.	<i>On</i> when 68010 is running. <i>Off</i> when 68010 processor is not running. <i>Flashing at 2 Hz</i> if the 68010 cannot run. (The watchdog and clock must be running.) (The Run LED is <i>on</i> in game mode.)
DTACK LED	State of 68010 DTACK (data acknowledge) signal.	<i>On</i> when the 68010 processor is running and the timing circuit is probably operating. <i>Flashes at 2 Hz</i> when the 68010 processor cannot run. (The watchdog and processor clock must be running.) (The DTACK LED is <i>on</i> in game mode.)
Clock LED	State of the 68010 processor clock signal.	<i>On</i> when the game board is on. <i>Off</i> if the processor clock signal is stuck high or low.
IRQS LED	State of all 68010 interrupts.	<i>On</i> in the game mode. <i>Off</i> in hardware diagnostic mode and the early part of self-test. <i>Off</i> if no interrupts are occurring or any interrupt signal is stuck low.

Setting the DIP Switches for the Tests

1. Put a jumper across the DIAGN test points, shown in Figure 2-29.
2. Select the diagnostic test you want to use with the DIP switch settings.
3. Turn on the self-test switch.
4. Put a jumper momentarily across the RESET test points, shown in Figure 2-29.

Changing to Another DIP Switch Test

1. Change the DIP switch settings.
2. Put a jumper momentarily across the RESET test points, shown in Figure 2-29.

Ending the DIP Switch Testing

1. Take the jumper off the DIAGN test points.
2. Put a jumper momentarily across the RESET test points.

The DIP switch settings are *on* in the top position when the Multisync PCB is in the simulator.

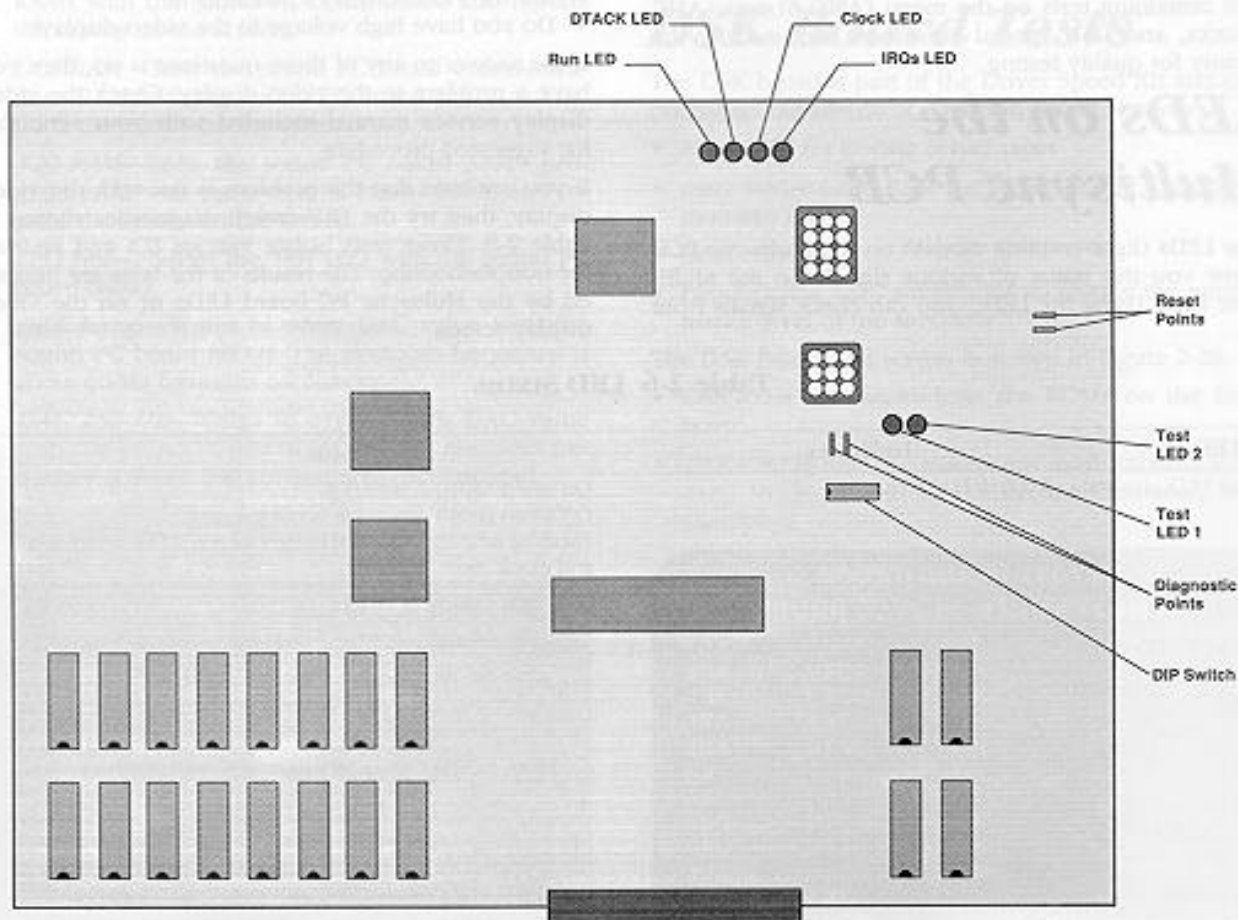

Figure 2-29 DIP Switch and LED Locations on the Multisync PCB

Table 2-7 Using the DIP Switches

Type of Test	Purpose and Results	DIP Switch Settings							
		1	2	3	4	5	6	7	8
Watchdog, Test Program ROMs, Test Menu RAMs, and LED Tests									
Uncleared Watchdog	Puts the 68010 in a loop. Does <i>not</i> clear the watchdog counter. The program RAM does not need to work. If the watchdog is working, the run LED, DTACK LED, and IRQs LED flash at 2 Hz and the clock LED is on.	X	X	0	0	0	0	0	0
Cleared Watchdog	Puts the 68010 in a loop. Clears the watchdog counter. The program RAM does not need to work. If the watchdog is working, the run LED, clock LED, DTACK LED and IRQs LED are on.	X	X	0	0	0	0	0	1
Test LEDs	Tests the test LEDs. The program RAM does not need to work. If the test LEDs are working, they flash at 2 Hz.	X	X	0	0	0	0	1	1
Test Program ROM 0	Tests ROM 0 H and 0 L, which hold the test program. (This test takes about 5 seconds.) LED 1 and LED 2 flash together if both ROMs are good. If ROM 0 L is bad, LED 1 does not flash. If ROM 0 H is bad, LED 2 does not flash.	X	X	0	0	0	1	1	1
Test Menu RAM 0	Tests RAM 0 H and 0 L, which run the test menu. (This test takes about 5 seconds.) LED 1 and LED 2 flash together if both RAMs are good. If RAM 0 L is bad, LED 1 does not flash. If RAM 0 H is bad, LED 2 does not flash.	X	X	0	0	1	1	1	1
GSP Tests									
GSP Communications	Tests if the 68010 can communicate with the GSP, which produces the video. If the GSP responds, the LEDs flash together. If the GSP does <i>not</i> respond, LED 1 and 2 flash alternately.	X	X	0	1	1	1	1	1
Red Screen	Produces a red screen from the color RAM, regardless of GSP VRAM input. Use this to check the red video outputs.	X	X	0	1	1	1	1	0
Green Screen	Produces a green screen from the color RAM, regardless of GSP VRAM input. Use this to check the green video outputs.	X	X	0	1	1	1	0	0
Blue Screen	Produces a blue screen from the color RAM, regardless of GSP VRAM input. Use this to check the blue video outputs.	X	X	0	1	1	0	0	0
GSP Memory Fill	Does a very slow GSP memory fill so you can test the pixel scanner.	X	X	0	1	0	0	0	0
GSP VRAM Verify	Performs the GSP VRAM verify test. (This test is also in the self-test.)	X	X	1	0	0	0	0	0
ROM and RAM Tests									
ROM Test Loop	The results are displayed on the screen.	X	X	1	0	0	0	0	1
RAM Test Loop	The results are displayed on the screen.	X	X	1	0	0	0	1	1
MSP Tests									
MSP Interface	Tests the MSP interface. Results are displayed on the screen.	X	X	1	0	0	1	1	1
MSP Auto Increment	Tests the MSP auto-increment. Results are displayed on the screen.	X	X	1	0	1	1	1	1
MSP Interrupts	Tests the MSP interrupts (IRQs). Results are displayed on the screen.	X	X	1	1	1	1	1	1
MSP DRAM Verify	Performs the MSP DRAM verify test. (This test is also in the self-test.) The results are displayed on the screen.	X	X	1	1	1	1	1	0
Bus Error Test									
BERR	The DTACK timer times out and generates a bus error (BERR) signal. The results are displayed on the screen.	X	X	1	1	1	1	0	0

1=On; 0=Off; X=Doesn't Matter.

Table 3-1 Troubleshooting All Controls

CHAPTER 3

Maintenance and Troubleshooting



This chapter includes maintenance, repair, and troubleshooting information for your Race Drivin' Compact simulator.

In the simulator, the hardware and software are closely related. If you are having problems with a mechanical assembly, always keep in mind that your electrical connections may not be good or you may have an electronic problem. To determine what kind of problem you have, always use the self-test screens as recommended for each part.

The first part of the chapter includes a schedule for simulator maintenance and inspection, a

table with general troubleshooting information, and a table of the voltage levels and test points on the PCBs. The rest of the chapter is arranged in alphabetical order by the name of the part or control. Under each part are maintenance procedures, troubleshooting tables and flowcharts, and repair procedures for the part.

All exploded parts illustrations are printed in Chapter 4, *Illustrated Parts Lists*.

Maintaining and Inspecting

Preventive maintenance includes inspecting, cleaning, lubricating, and tightening hardware. Perform the preventive maintenance regularly so you can keep the simulator in top condition, avoid problems, and maximize your earnings. Preventive maintenance tasks and intervals are shown in Table 3-1.

For the best performance from your Race Drivin' Compact simulator, maintain your simulator according to the times shown in Table 3-1. Instructions for performing these tasks is explained in the section about that control in this chapter. You may want to perform these tasks more often if the simulator is heavily used.

Table 3-2 shows the correct voltage levels to various PC boards and the test points for those voltage levels. Low voltages to PC boards may cause problems with the controls, with the video display, or in driving.

Table 3-1 Maintenance and Inspection Items

Part	When to Check	What to Check and Maintain
All Controls	Every month	Use the <i>Control Inputs</i> screen to check the inputs from the controls to the Multisync PCB.
Coin Mechanism	Every 6 months	Clean.
Pedals	Every 3 months	Grease links. Check that the potentiometers are tight.
Interior Components	Every 3 months	Clean.
Key Switch	Every 3 months	Lightly oil the spring and shaft.
Shifter	Every 3 months	Grease ball bearing and shifter pattern. Check that the body of the switches are not cracked. Make sure the switches are tight on the shifter. (Do not overtighten the screws on the switches.)
Steering Assembly	Every 2 months	Go through the <i>Set Controls</i> screens to adjust the steering assembly settings for belt wear. Put oil in the ball bearing.

Table 3-2 Voltage Inputs and Test Points on the Simulator PCBs

PCB	Voltage	Test Points	Source and Purpose
Main	+5±0.1 VDC	+5V2	+5 V Switching Power Supply
Main	+15±0.6 VDC	+15V1	Regulated and supplied by the APU PCB. Used by the 12-bit A/D converter and runs the +12 VDC regulator.
Main	-22 VDC	-22V1	Unregulated and supplied by the APU PCB. Runs the -5V regulator.
Main	+12±0.5 VDC	+12V1	Regulated and comes from the +15 VDC supply. Used by the 12-bit A/D converter and the sound PCB.
Main	-5±0.2 VDC	-5V1	Regulated and comes from the unregulated -22 VDC supply. Used by the 12-bit A/D converter and the sound PCB.
ADSP	+5 VDC	+5V1 or +5V2	Regulated and supplied from the Multisync PCB through the interface cable.
Sound	+5 VDC	+5V2	Supplied and regulated by the Multisync PCB through the sound power cable. Used by the logic circuitry.
Sound	+12 VDC	105B Pin 4	Supplied and regulated by the Multisync PCB through the sound power cable. Used by the analog circuitry.
Sound	-5 VDC	5R Pin 4	Supplied and regulated by the Multisync PCB through the sound power cable. Used by the analog circuitry.
Sound	+5 VDC	+5V2	Supplied and regulated by the Multisync PCB through the interface cable.
Sound	-15 VDC	105B Pin 11	Supplied by the APU PCB through the Multisync PCB. Used by the 12-bit D/A converter on the sound PCB
APU	+14VDC	See schematics	Used by the coin counters and the audio amps on the APU PCB.
APU	-14VDC	See schematics	Used by audio amps on the APU PCB.
APU	-22VDC	See schematics	Used by the Multisync PCB.
APU	+15VDC	See schematics	Regulated; used by the Multisync PCB.

Table 3-3 Troubleshooting All Controls

Problem	Solution
All controls do not respond or respond erratically.	<ol style="list-style-type: none"> 1. Go through the <i>Set Controls</i> screens in the self-test. 2. Have you recently installed a new PCB or new controls? If so, go through the <i>Set Controls</i> screens in the self-test. 3. Check the ZRAMs in the self-test for errors. 4. The simulator may have lost power during a ZRAM test. Go through the <i>Set Controls</i> screen in the self-test.

Table 3-3 is the first of ten troubleshooting tables in this chapter. Use this table if *all* of your controls are acting erratically or not responding. If only one control is not working, go to the section about that control and read the troubleshooting information there.

Coin Mechanism

The coin mechanism should be cleaned every three months.

Maintaining the Coin Mechanism

1. Turn off the power to the game. Open the upper coin door.
2. Open the gate on the door covering the magnet. Use the blade of a screwdriver to scrape away any metal filings collected on the magnet.
3. For a thorough cleaning, wash the coin mechanism in hot soapy water. Use a toothbrush to remove any stubborn build-up of residue in the coin path.
4. Dry the coin mechanism with compressed air.
5. If you do not want to use water, brush the loose dust off with a soft brush and scrub the residue in the coin path with a toothbrush. Blow all the loose dust and dirt out with compressed air.

NOTE

Never lubricate the coin mechanism with oil or grease.

Dashboard

Generally you do not need to remove the dashboard to work on the controls. You can work on the key switch, shifter, and steering assembly without removing the dashboard. To remove these controls from the cabinet, see the section on that control for information.

Removing the Dashboard

1. Turn off the power to the game.
2. Remove the three tamperproof screws and washers in the cover plate of the steering wheel. Take off the steering wheel and cover plate. See Figure 4-2.
3. Open the back service panel. Remove the nuts on the six carriage bolts through the bottom of the cabinet shelf and push the carriage bolts through the cabinet shelf.
4. Also remove the nuts on the two carriage bolts through the front of the dashboard. These bolts have spring nuts on them and you cannot push them through the cabinet.
5. Disconnect the key switch harness, abort button harness, and shifter harness from the simulator harness.
6. In the front, remove the four low crown nuts on the side carriage bolts. Remove the carriage bolts.
7. Take the dashboard off the game.

Installing the Dashboard

1. Put the dashboard on the cabinet. Push the harnesses through the cutouts.
2. Loosely install the carriage bolts and low-crown nuts on the sides of the dashboard.
3. Go to the back of the cabinet and install the fender washers and nuts on the carriage bolts on the front of the dashboard.
4. Insert the other carriage bolts through the bottom the dashboard and put the washers and nuts on them.
5. Connect the key switch harness, abort button harness, and shifter harness to the simulator harness.
6. Tighten the low-crown nuts on the sides of the dashboard.
7. Put on the steering wheel. Install the three tamperproof screws and washers through the center cover plate.

Interior Components

All the components in the interior of the simulator should be cleaned every three months. This includes the PCBs, the power supply and the video display.

Cleaning the Interior Components

Perform the following procedure to clean the components inside the cabinet.

1. Open the rear service door and the top service door.

WARNING

Turn off the AC power, but do not unplug the power cord before cleaning inside the cabinet. The power cord provides a ground path for static voltage that can be present on the cleaning tools.

2. Use a vacuum cleaner with a soft long-bristled brush attachment or use a soft-bristled paint brush to remove loose dirt and dust accumulated on the inside of the cabinet. Be sure to clean the power supply, PCB assemblies, and video display thoroughly.

CAUTION

Be extremely careful when cleaning the electrical components inside the cabinet. Do not touch the electrical components with any solid object other than the soft bristles of the vacuum attachment or paint brush.

Key Switch Assembly

Table 3-4 lists what can go wrong with the key switch assembly.

Oiling the Key Switch Assembly

Oil the key switch spring and shaft when turning the key switch becomes difficult, or when the key squeaks.

1. Turn off the power. Remove the back service door.
2. Remove the nuts and washers on the carriage bolts that hold the key switch assembly on the dashboard. Take the key switch out of the game.

3. Lightly oil the shaft and spring of the key switch. See Figure 4-5. Check that the spring is not broken. If it is, then replace the spring following the procedure under *Repairing the Key Switch*.
4. Replace the key switch in the dashboard. Put the nuts and washers on the carriage bolts that hold the key switch on the dashboard. Tighten the nuts.

Replacing the Spring in the Key Switch Assembly

If nothing happens when the key turns, and there is no resistance to turning, you may need to replace the spring.

1. Turn off the power. Remove the back service door.
2. Remove the nuts and washers on the carriage bolts that hold the key switch assembly on the dashboard. Take the key switch out of the game.
3. Remove the retaining ring from the back of the key switch case. See Figure 4-5.
4. Loosen the socket-head screw on the brass actuator with a 5/32-inch Allen-head wrench.
5. Remove the other retaining ring inside the case. Pull out the key. Take out the brass actuator, the old spring, and the nylon washer.
6. Put lithium grease (Atari Games part no. 107029-001) on the housing where it touches the shaft. Wipe off the excess grease.
7. Put one end of the spring into the hole in the side of the case.
8. Push the shaft back into the case far enough to mount the spring on the shaft. You may have to cut the legs of the spring to the correct length so that they do not interfere with the operation of the switch assembly.
9. Put the brass actuator into the case with the actuator pin facing the key and opposite the switch. Catch the free end of the spring under the pin. Push the actuator and the nylon washer onto the shaft.
10. Push the shaft through the case and install the two retaining rings.
11. Adjust the actuator on the shaft until it is parallel to the roller on the switch.
12. When the actuator is against the case opposite the switch, the key should be vertical. If the key is not vertical, turn it until it is. Tighten the screw on the actuator.
13. Use a piece of a manila folder or any other flat material about .015 inches thick to adjust the switch distance. Hold the actuator against the side of the assembly with the flat piece of material between the actuator and the switch. The switch should

press against the material. Tighten the screws on the switch to hold it in place.

Release the actuator. Check the setting. When you turn the actuator against the switch, the switch should click but not be pressed all the way to the switch body.

14. Replace the key switch in the dashboard. Put the nuts and washers on the carriage bolts that hold the key switch on the dashboard. Tighten the nuts.

Tightening the Screw in the Key Switch Actuator

If nothing happens when the key turns, and it turns more than 90°, you may need to tighten the screw on the actuator.

1. Turn off the power. Remove the back service door.
2. Remove the nuts and washers on the carriage bolts that hold the key switch assembly on the dashboard. Take the key switch out of the game.
3. Adjust the actuator on the shaft until it is parallel to the roller on the switch. See Figure 4-5.
4. When the actuator is against the case opposite the switch, the key should be vertical. If the key is not vertical, turn it until it is. Tighten the screw on the actuator.
5. Use a piece of a manila folder or any other flat material about .015 inches thick to adjust the switch distance. Hold the actuator against the side of the assembly with the flat piece of material between the actuator and the switch. The switch should press against the material. Tighten the screws on the switch to hold it in place.

Release the actuator. Check the setting. When you turn the actuator against the switch, the switch should click but not be pressed all the way to the switch body.

6. Replace the key switch in the dashboard. Put the nuts and washers on the carriage bolts that hold the key switch on the dashboard. Tighten the nuts.

Replacing the Switch on the Key Switch Assembly

Replace the switch if the key turns but nothing happens and the problem is not the spring, the actuator, or the connections. The key switch assembly is shown in Figure 4-5.

1. Turn off the power. Remove the back service door.
 2. Remove the nuts and washers on the carriage bolts that hold the key switch assembly on the dashboard. Take the key switch out of the game.
 3. Remove the two Phillips-head screws that hold the snap-action switch on the key switch assembly. Take off the switch. Take the harness off the switch.
 4. Install the switch on the assembly, but do not tighten the screws. The roller on the switch should face the brass switch actuator.
 5. Loosen the screw on the brass actuator. Adjust the actuator on the shaft until it is parallel to the roller on the switch.
 6. When the actuator is against the case opposite the switch, the key should be vertical. If the key is not vertical, turn it until it is. Tighten the screw on the actuator.
 7. Use a piece of a manila folder or any other flat material about .015 inches thick to adjust the switch distance. Hold the actuator against the side of the assembly with the flat piece of material between the actuator and the switch. The switch should press against the material. Tighten the screws on the switch to hold it in place.
- Release the actuator. Check the setting. When you turn the actuator against the switch, the switch should click but not be pressed all the way to the switch body.
8. Put the harness on the new switch. Connect the black wire to the C (or COM) terminal, and the white wire to the NO terminal.
 9. Replace the key switch in the dashboard. Put the nuts and washers on the carriage bolts that hold the key switch on the dashboard. Tighten the nuts.

Table 3-4 Troubleshooting the Key Switch

Problem	Solution
Key does not return to center when turned and it has no resistance.	The actuator screw may be loose or the spring may need to be replaced.
Key turns more than 90°.	The actuator is loose; tighten the screw on the actuator.
Key turns, but nothing happens.	Check the snap-action switch, switch connectors, actuator location, and harness connections.
Key squeaks when turned.	Oil the shaft and spring.

Pedals

The construction for all the pedals is very similar. The main difference is that the brake has a strain gauge and connector bonded to the pedal. The strain gauge transmits information about the force on the brake to the Multisync PCB. The gas and clutch pedals use potentiometers to transmit position information to the Multisync PCB.

If the Gas or Clutch Pedal Does Not Work

Before you do any repairs, always perform the *Set Controls* screens in the self-test; then try the pedal to see if this corrects the problem. If that does not repair the problem see Table 3-5, *Troubleshooting the Gas and Clutch Pedal* and follow the flowchart in Figure 3-1.

If you must repair the clutch, but you cannot do so immediately, disable the clutch circuit. (You cannot disable the gas pedal circuit.) If you disable the clutch circuit, drivers can only use the automatic transmission mode.

To disable the clutch circuit, go to the *Disable Broken Controls* screen in the self-test and choose *broken* for the clutch. Disable the clutch *only* as a temporary measure. Repair the clutch as soon as possible since this is an essential part of the game.

If the Brake Pedal Does Not Work

If you have problems with the brake, make sure the simulator has been on for at least 10 minutes. The brake may not work right if the simulator has not been on long enough.

Before you do any repairs, always perform the *Set Controls* screens in the self-test but only after the simulator has been on at least 10 minutes. Try the brake to see if this corrects the problem.

If that does not fix the problem, see Table 3-6, *Troubleshooting the Brake Pedal*, and follow the flowchart in Figure 3-2. If you decide you must check the strain gauge, follow the procedure in *Testing the Brake Pedal Strain Gauge and Bonding* section.

If you must repair the brake, but you cannot do so immediately, and you want to continue to use your game, disable the brake circuit. When you disable the brake, a screen appears before each race which tells each driver that the brake does not work; if he wants to slow down, he should take his foot off the accelerator.

To disable the brake circuit, go to the *Disable Broken Controls* screen in the self-test and choose *broken* for

the brake. Disable the brake only as a temporary measure. Repair the brake as soon as possible, since this is an essential part of the game.

Greasing and Checking the Pedals

Grease the pivot shafts every three months with multi-purpose white grease (Atari Games part number 178027-001).

1. Turn off the power to the simulator.
2. Take each pedal assembly out of the simulator. Remove the two button-head and two tamperproof screws and washers holding the assembly in the cabinet. Unscrew the two screws holding the gas pedal to the floor if you are removing the gas and brake pedal assembly.
See Figure 4-6 for the brake and gas pedals and Figure 4-7 for the clutch pedal.
3. Pull the assembly forward and disconnect the pedal harness(es) from the simulator harness.
4. Put white grease on the pin holding the lower and upper links together. Work the grease around on the pivot shaft.
5. Check the parts of the pedal to make sure they are working correctly. Check and tighten (if necessary) the jam nuts on the links and the screw at the end of the pedal shaft. Tighten any other screws that have come loose.
6. Install the assembly in the cabinet. Attach the pedal harness to the simulator harness.
7. Install the screws and washers.

Replacing a Pedal

Replace a pedal only if the pedal or the pedal shaft is broken. If the pedal is wobbly, tighten the screw that holds the pedal in the pivot shaft.

Removing a Pedal

1. Turn off the power to the simulator.
2. Take the pedal assembly out of the simulator by removing the two button-head screws and two tamperproof screws and washers holding the assembly in the cabinet. Unscrew the two screws holding the gas pedal to the floor if you are removing the gas and brake pedal assembly. See Figure 4-6 for the brake and gas pedals and Figure 4-7 for the clutch pedal.
3. Pull the assembly forward and disconnect the pedal harness(es) from the simulator harness.
4. Remove the lower link if you are working on the clutch or the gas pedal.

- Remove the hex-head screw that holds the pedal on the shaft. Pull off the pedal.

WARNING

The springs will pop when you take off the pedal. Keep your fingers away from the springs.

Installing a Pedal

If you are installing a brake pedal, do not install the pins in the connector or put the tie wrap on the pedal until the pedal is installed in the assembly.

- Before you put the pedal in the assembly, turn the pivot shaft so the hole in the pivot shaft with the square cut-out around it is pointing towards the front of the assembly. See the detail in Figure 4-6.
- Make sure the spring(s) are hooked over the spring anchor shaft. Hook a screwdriver through the springs from the back of the assembly to hold them in tension. This makes it easier to insert the pedal through the springs and into the hole in the pivot shaft.

With the springs held in tension, insert the pedal into the pivot shaft.

- Put the hex-head screw into the end of the pedal in the pivot shaft.
- Grease the pin that holds the lower and upper links together.
- Attach the lower and upper links together with the pin. Set the upper link so it is 22° clockwise from vertical.
- If you have installed a brake pedal, put the tie wrap on the the pedal shaft to hold the wires in place.

Insert the pins into the connector.

- Put the assembly in the game. Connect the pedal harness(es) to the simulator harness.

- Install the screws and washers that hold the assembly in the cabinet.

NOTE

Enter the self-test and go through the Set Controls screens because you replaced the pedal. Otherwise the simulator will not work correctly.

Replacing a Spring

Replace the pedal spring(s) if they are weak, broken, or sprung.

- Turn off the power to the simulator.
- Take the pedal assembly out of the simulator by removing the two button-head and two tamperproof screws and washers holding the assembly in the cabinet. If you are working on the brake and gas assembly, remove the screws holding the gas pedal to the floor. See Figure 4-6 for the brake and gas pedals and Figure 4-7 for the clutch pedal.
- Pull the assembly forward and disconnect the pedal harness(es) from the simulator harness.
- Remove the lower link if you are working on the clutch or the gas pedal.
- Remove the hex-head screw that holds the pedal on the shaft. Pull off the pedal.

WARNING

The springs will pop when you take off the pedal. Keep your fingers away from the springs.

- Take the pedal assembly off the front metal plate by removing the four nuts on the carriage bolts.
- Remove the bumper shafts, spring shafts and support shafts, which hold the assembly together.

Table 3-5 Troubleshooting the Clutch or Gas Pedal

Problem	Solution
Pedal does not work or works erratically.	<ol style="list-style-type: none"> Perform the <i>Set Controls</i> screens in the self-test. Follow the flowchart in Figure 3-1 to find the cause of the problem. Check the connections. Check the voltage levels to the Multisync PCB. See Table 3-3. If you had disabled the pedal circuit, but the pedal assembly is now repaired, choose <i>working</i> on the <i>Disable Broken Controls</i> screen.
Pedal does not return.	<ol style="list-style-type: none"> Check the springs and bearings. The springs may be broken or weak.
Pedal is wobbly.	<ol style="list-style-type: none"> Tighten the nut at the end of the pedal shaft.

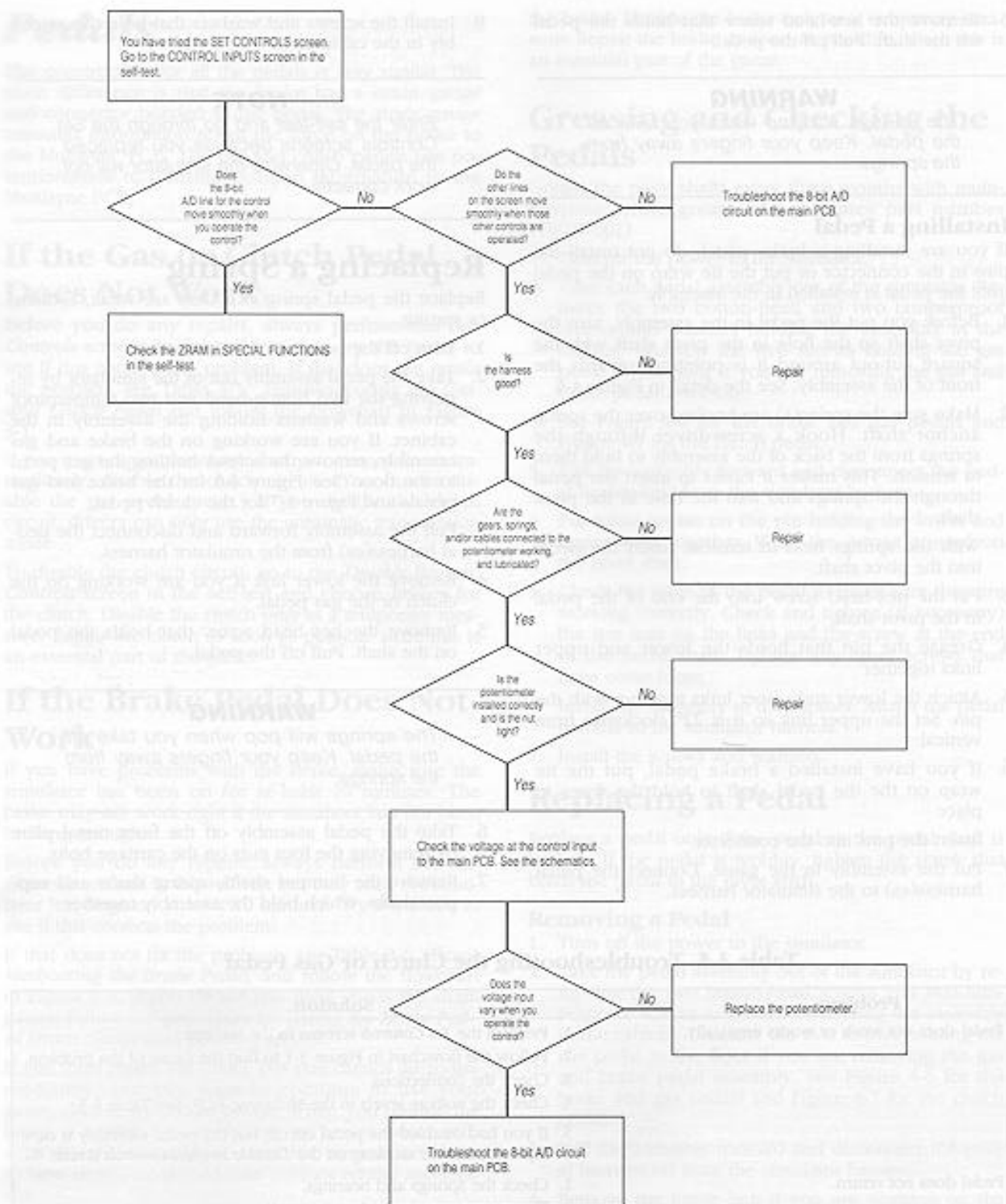

Figure 3-1 Clutch or Gas Pedal Is Not Working or Is Working Erratically and You Have Tried the *Set Controls* Screens

8. Replace the spring(s). If the pedal has two springs, replace both of them.
9. Lubricate the pivot shaft with multi-purpose grease before you put it back into the assembly.
10. Assemble the shafts in the pattern shown in Figure 4-6 for the gas or brake pedal or Figure 4-7 for the clutch pedal. If you have disassembled the brake pedal, be sure to put the large brake bumper and bumper shaft on the bottom.
11. Install the pedal assembly on the front metal plate with the four nuts and washers on the carriage bolts.
12. Before you put the pedal in the assembly, turn the pivot shaft so the hole in the pivot shaft with the square cut-out around it is pointing towards the front of the assembly. See the detail in Figure 4-6.
13. Make sure the spring(s) are hooked over the spring anchor shaft. Hook a screwdriver, or any other long thin piece of metal, through the springs from the back of the assembly to hold them in tension. This makes it easy to insert the pedal through the springs and into the hole in the pivot shaft.
With the springs held in tension, insert the pedal into the pivot shaft.
14. Put the hex-head screw into the end of the pedal in the pivot shaft.
15. If you are working on the clutch or gas pedal, grease the pin that holds the links together.
16. Attach the lower and upper links together with the pin. Set the upper link so it is 22° clockwise from vertical.
Tighten the jam nut on the lower link on the pivot shaft.
17. Put the assembly in the game. Connect the pedal harness(es) to the simulator harness.
18. Install the screws and washers that hold the assembly in the cabinet.

Replacing the Clutch and Gas Pedal Potentiometers

Do not replace a potentiometer until you have performed the *Set Controls* screens. Check to see if that solves the problem. If not, follow the flowchart in Figure 3-1 to make sure that the potentiometer is the problem.

1. Turn off the power and unplug the game.
2. Take the pedal assembly out of the simulator by removing the two button-head screws and two tamperproof screws and washers holding the assembly in the cabinet. Remove the two screws that hold the gas pedal to the floor of the simulator. See Fig-

ure 4-6 for the brake and gas pedals and Figure 4-7 for the clutch pedal.

3. Pull the assembly forward and disconnect the pedal harness(es) from the simulator harness.
4. Take the wires off the potentiometer.
5. Loosen the jam nut on the upper link on the potentiometer shaft. Remove the upper link.
6. Loosen the 1/2-inch nut on the potentiometer shaft and remove the potentiometer.
7. Install the potentiometer so the key is in the key slot at the top, the terminals point to the back of the assembly, and the flat of the shaft is facing up.
8. Solder the wires onto the potentiometer in the order shown in Table 3-7.
9. Install the assembly in the simulator. Connect the pedal harness(es) to the simulator harness.
10. Now switch on the self-test and go through the *Set Controls* screens.

NOTE

Enter the self-test and go through the Set Controls screens because you repaired the pedal assembly.

Testing the Brake Pedal Strain Gauge and Bonding

If you have brake problems, see the flowchart in Figure 3-2. If necessary, do the following tests to check the strain gauge and strain gauge bonding.

1. Put an ohmmeter across pins 1 and 2 of the brake harness connector. If the ohmmeter does not measure $350 \Omega \pm 10\%$, the strain gauge is bad or the connection is bad. Replace the brake pedal and the strain gauge.
2. If the ohmmeter does measure $350 \Omega \pm 10\%$, then check the bonding. Attach a digital volt-ohmmeter to pins 1 and 2 and have someone press hard on the brake.

NOTE

Use a sensitive ohmmeter to check the change in resistance since the change is only about 1 Ohm.

If the resistance does not change as the pressure on the brake pedal changes, then the bonding has failed and you must replace the brake pedal and the strain gauge.

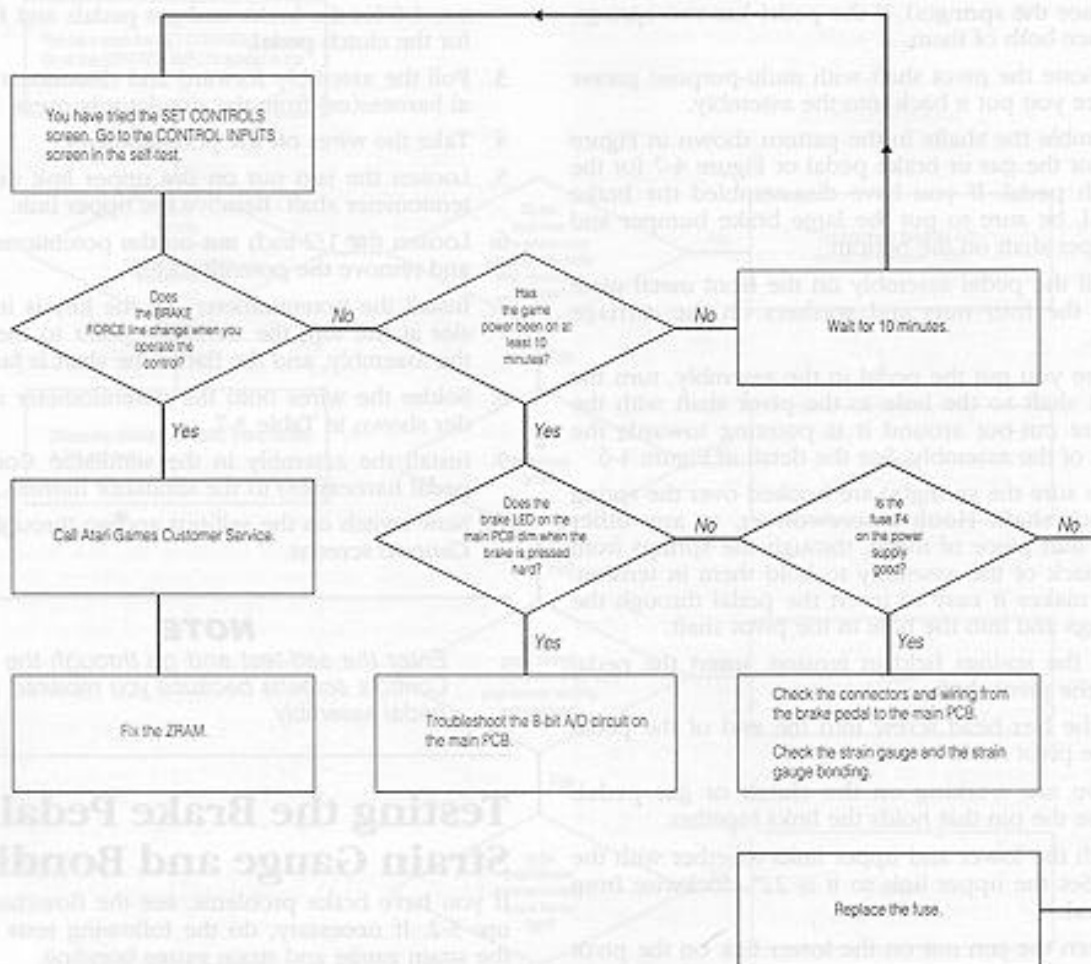

Figure 3-2 Brake Pedal Is Not Working or Is Working Erratically and You Have Tried the *Set Controls* Screens

Table 3-6 Troubleshooting the Brake Pedal

Problem	Solution
Brake does not work or is working erratically.	<ol style="list-style-type: none"> 1. Go through the <i>Set Controls</i> screens in the self-test. The simulator must be on at least 10 minutes before you do this. 2. Follow the flowchart in Figure 3-2. 3. Check the brake force on the <i>Control Inputs</i> screen. As you press down on the brake, the line should disappear in relation to how much force you are putting on the brake. 4. Check the harness connections. 5. Check the strain gauge as described in <i>Testing the Strain Gauge and Bonding</i>. 6. Check the voltage level to the Multisync PCB. See Table 3-3. 7. If the brake was not working, and you disabled the brake circuit, but now the brake is repaired, go to the <i>Disable Broken Controls</i> screen and choose <i>working</i>.
Pedal is wobbly.	Tighten the nut at the end of the pedal shaft.

Table 3-7 Pedal Potentiometers Harness Connections

Potentiometer Terminal		Wire
Gas Pedal	Top	Red
	Center	White
	Bottom	Black
Clutch Pedal	Top	Red
	Center	Yellow
	Bottom	Black

Replacing the Brake Strain Gauge

If you have tested the strain gauge and are sure that the gauge or the bonding is bad, you must replace the brake pedal with the strain gauge already attached since special bonding techniques are required. Follow the steps in *Replacing the Brake Pedal*.

Shifter Assembly

If you have problems with the shifter, check Table 3-8, *Troubleshooting the Shifter Assembly*.

If you must repair the shifter, but you cannot do so immediately, and you want to continue to use your simulator, disable the shifter circuit. When you disable the shifter, drivers can only use the automatic transmission mode.

To disable the shifter circuit, go to the *Disable Broken Controls* screen in the self-test and choose *broken* for the shifter. Disable the shifter only as a temporary measure. Repair it as soon as possible since this is an essential part of the simulator.

Lubricating the Shifter

1. Turn off the power. Open the back service door.
2. Remove the shifter from the dashboard. Remove the nuts and washers on the four carriage bolts that hold the shifter, shifter spacer, and shifter bezel on the dashboard. Take off the shifter, spacer, and bezel.

3. Remove the six screws that hold the two halves of the shifter case together. See Figure 4-4. Carefully pull apart the case. The ball bearing can fly out since it is under compression. The spring will pop out too.
4. Lubricate the ball bearing under the shifter handle and the shifter pattern in the bottom of the shifter. Use light-duty white grease, Atari Games part number 178027-001.
5. Reassemble the shifter and shifter spacer.
6. Put the shifter, shifter spacer, and shifter bezel back on the dashboard and install the carriage bolts, washers, and nuts that hold them in place. You may need someone to help you.

Replacing a Shifter Switch

Before you replace a switch, check the shifter switches on the *Control Inputs* screen in the self-test. If a gear position number does not change from blue to green when you move the shifter into that position, then probably the switch or the connection is bad.

1. Open the back service door. Check the connections to the shifter. See Table 3-9.

If the connections are correct and tight, turn off the power. Remove the four nuts and washers that hold the shifter, shifter spacer and bezel on the dashboard. See Figure 4-4. Take out the shifter, spacer and bezel.

3. Make sure the shifter handle is not engaging the switch you are replacing.
4. Carefully remove the switch on the shifter so the actuator pin and spring above the switch do not fly off and are lost.
5. Replace the switch. Install the pin and spring.
6. Connect the harness to the switch with the wires in the order shown in Table 3-9.
7. Assemble the shifter and shifter spacer and install them in the dashboard.
8. Reassemble the shifter and shifter spacer.
9. Put the shifter, shifter spacer, and shifter bezel back on the dashboard and install the carriage bolts, washers, and nuts that hold them in place. You may need someone to help you.

Table 3-8 Troubleshooting the Shifter

Handle moves, but the shifter does not shift gears.	Use the <i>Control Inputs</i> screen to check if switches are working. Check if switches are screwed on tightly. Check if switches are broken or the switch body is cracked. Check if the return plunger spring over the switch is pinched or broken.
---	--

Table 3-9 Harness Connections to the Shifter Switches

Gear Position	Color of Harness Wire	
1	Brown, N.O.	Black, C.
2	Orange, N.O.	Black, C.
3	Yellow, N.O.	Black, C.
4	Green, N.O.	Black, C.

Speakers

If you have problems with a speaker, check Table 3-10, *Troubleshooting the Speakers*, before you replace it.

Removing a Speaker

1. Turn the power off. Remove the back service door.
2. Disconnect the connectors from the speaker that is bad. Remove the screws that hold the speaker in the cabinet.

CAUTION

Be careful when handling the speaker. The cone material is fragile and can be easily damaged.

3. Remove and replace the speaker.
4. Connect the speaker to the simulator harness. Make sure you attach the connectors correctly.

The signal wire should be attached to the speaker terminal marked by color, a "+" sign, or a round dot. (The signal wire is indicated on the simulator wiring diagram in the *Schematic Package*.)

Static-Sensitive Devices

Be careful when you work with static-sensitive devices on the simulator PCBs. These devices can be microprocessors, field-effect transistors (FET), complementary metal-oxide semiconductors (CMOS), and other large-scale integration (LSI) devices that use metal-oxide semiconductor (MOS) technology.

Replacing Static-Sensitive Devices

The static-sensitive devices can fail from a static charge that has built up in your body. They can also fail because of leakage from an improperly grounded soldering iron.

Before you handle a static-sensitive device or a PCB with such devices attached to it, ground any static voltage that may have accumulated in your body by touching an object that is earth-grounded. If you solder a static-sensitive device, use a soldering iron with a properly grounded three-wire cord.

Before you replace a static-sensitive device, make sure that the device actually is defective. A static-sensitive device can appear defective due to leakage on a PCB. To check if a device is defective, ground any static voltages as described in the paragraph above. Clean both sides of the PCB with flux remover or an eraser. For discrete FETs, clean thoroughly between the gate, drain, and source leads. Then test the device.

A new static sensitive device may be packaged in conductive foam or may have a protective shorting wire attached to the pins. Remove the conductive foam just prior to inserting the device into its socket or soldering it to a PCB. Remove the shorting wire only after the device is inserted into its socket or after all the leads are soldered in place.

Steering Assembly

If you have problems with the steering assembly, check the troubleshooting suggestions in Table 3-11. Always perform the *Set Controls* screens in the self-test first. You should regularly go through the *Set Controls* screen to adjust the set points on the steering assembly to account for wear on the belt.

Oiling the Bronze Bearing

The only bearing on the steering assembly that must be oiled regularly is the bronze pillow block bearing behind the steering wheel. See Figure 4-3.

1. Take off the back service door.
2. The bearing fill hole is on the right. Use an oil can with a flexible spout and put oil in the bearing.

Adjusting the Steering Belt

The belt itself cannot be adjusted, but the limits of the steering movement can be changed to adjust for belt wear. You should do this every two months by going through the *Set Controls* screens.

If the belt is very loose and resetting the set points does not improve the steering, then replace the belt.

Replacing the Steering Belt

Replace the belt on the steering assembly if it is broken or loose. However, before you replace the belt because it is loose, use the *Set Controls* screen to see if this will fix the problem. By resetting the steering lim-

Table 3-10 Troubleshooting the Speakers

Problem	Solution
No sound	<p>Make sure the volume is turned up.</p> <p>If the volume is turned up, do the following:</p> <p>Do the self-test to make sure you do not have a sound PCB problem.</p> <p>Check the voltage level to the sound PCB.</p> <p>Check the wiring.</p> <p>Replace the speaker if defective.</p> <p>If none of the above work, the problem may be on the APU PCB or the Multisync PCB.</p>

its on this screen, you can adjust the outputs to compensate for wear in the belt.

1. Turn off the power to the simulator. Take off the back service door.
2. Remove the belt by pushing the motor towards the steering wheel mounting shaft and working the belt off the pulleys. See Figure 4-3.
3. Install the new belt by pushing the motor towards the steering wheel mounting shaft and putting the belt on the pulleys.
4. Put oil in the fill hole on the bronze bearing on the steering wheel mounting shaft if you have not done this in the last three months.
5. Replace the back service door.

NOTE

You must enter the self-test and go through the Set Controls screens because you repaired the steering assembly. Otherwise the simulator will not work correctly.

Replacing the Steering Motor

Replace the steering assembly motor if you have followed the flowchart in Figure 3-3, 3-5, or 3-6 and you are sure that the motor is the problem. Another reason to replace the motor is if the steering wheel is difficult to turn and the problem is not lubrication or the mechanical parts.

Before you replace the motor, check the harness connections to make sure they are good.

Removing the Motor

1. Turn off the power to the simulator.
2. Remove the three tamperproof screws and washers in the cover plate of the steering wheel. Take off the steering wheel and cover plate. See Figures 3-8 and 3-9.

3. Take off the back service door. Disconnect the steering assembly harness from the simulator harness. Disconnect the motor power from the motor amplifier PCB assembly.

Remove the screw down tie wrap from the side of the cabinet.

4. Remove the four nuts that hold the steering assembly on the shelf. Push the screws through holes in the shelf. Remove the steering assembly.
5. Remove the harness from the encoder PCB.
6. Take off the two screws that hold the encoder PCB on the assembly. Remove the PCB.
7. Remove the encoder disk, disk collar, and disk stiffening ring by loosening the socket-head screw on the disk collar.
8. Remove the belt by pushing the motor towards the steering wheel mounting shaft and working the belt off the pulleys.
9. Remove the pulley on the motor by loosening the socket head screw that holds it on. (The socket-head screw has a penetrating adhesive on it.)
10. Remove the nut and hex-head bolt that holds the spring in tension.
11. Take off the 1/2-inch retaining ring at the front of the motor on the pivot shaft.
12. Pull the pivot shaft out the back of the steering assembly. Remove the motor.
13. Remove the four socket-head screws and washers on the front of the motor.

Installing the Motor

1. Install the pivot plate on the front of the motor. Align the bottom of the pivot plate with the bottom flat edge of the motor bezel.

Install the four socket-head screws with the split-lock washers and flat washers that hold the pivot plate on the motor. Tighten the screws to 30 ± 5 inch-pounds.

2. Put the motor and pivot plate in the assembly with the label and harness on top.

Table 3-11 Troubleshooting the Steering Assembly

Problem	Solution
Steering wheel does not respond or responds erratically.	<ol style="list-style-type: none"> 1. Go through the <i>Set Controls</i> screens in the self-test. 2. Check voltage level to Multisync PCB. See Table 3-3.
Steering wheel is difficult to turn.	<ol style="list-style-type: none"> 1. Check the steering assembly for broken parts. 2. Check the motor bearings by turning the shaft and seeing if it spins freely.
Steering has no feedback.	<ol style="list-style-type: none"> 1. Try the <i>Set Controls</i> screens in the self-test. 2. See Figure 3-6 to determine the cause of the problem.
Steering is very jerky.	<p>Some jerkiness is OK.</p> <ol style="list-style-type: none"> 1. Try the <i>Set Controls</i> screens in the self-test. 2. If you think the steering is very jerky, see the flowchart in Figure 3-5 for more information.
Steering wheel continuously turns one direction.	<ol style="list-style-type: none"> 1. Try the <i>Set Controls</i> screens in the self-test. 2. See the flowchart in Figure 3-10 for more information.
In the <i>Control Inputs</i> screen, the <i>Steering Wheel</i> numbers do not change And the steering is erratic.	The encoder disk is bent. Replace the disk.
the <i>Steering Wheel</i> numbers do not change and there is no steering power.	The encoder PCB or connections to the Multisync PCB are bad. Repair the connection, replace the harness, troubleshoot the Multisync PCB, or replace the encoder PCB.
the <i>Steering Wheel</i> numbers do not change and the centering disk is scraping against the optical readers.	Replace or center the centering disk.
the words <i>Center Edge</i> do not change from blue to green, and the steering is erratic.	The centering disk is bent. Replace the disk.
the words <i>Center Edge</i> do not change from blue to green, and there is no steering power.	The centering PCB or connections to the Multisync PCB are bad. Repair the connection, replace the harness, troubleshoot the Multisync PCB, or replace the centering PCB.
the words <i>Center Edge</i> do not change from blue to green, and the centering disk is scraping against the optical readers.	Replace or center the centering disk.
Steering has no force or low force.	<ol style="list-style-type: none"> 1. Go through the <i>Set Controls</i> screen. 2. Are the pulleys aligned? 3. Replace the belt.
Steering wheel is not centered during game play.	<ol style="list-style-type: none"> 1. Go through the <i>Set Controls</i> screen. 2. Are the pulleys aligned? 3. Replace the belt.

3. Push the pivot shaft through the frame, washers, motor, and pivot shaft as shown in Figure 3-4. Install the 1/2-inch retaining rings on the ends of the pivot shaft as shown in the figure.
4. Assemble the hardware that holds the spring in tension. See Figure 4-3. Install the parts on the bolt in the following order:
 - a. 1/4-inch-long spacer. Hook the end of the spring around this spacer.
 - b. Washer.
 - c. 5/8-inch-long spacer.
 - d. Washer.
5. Install the bolt with the hardware on the outside of the frame. Put the lock nut on the bolt inside the frame and tighten it to 212 ± 20 inch-pounds.
6. Remove the socket-head screw from the pulley you took off the motor. Put a penetrating adhesive on the screw. Slide the pulley back on the motor shaft. Align this pulley to the other one. Turn the pulley so the screw hole is over the flat of the shaft. Install the socket-head screw. Tighten the screw to 50 ± 8 inch-pounds. Install the belt on the pulleys.

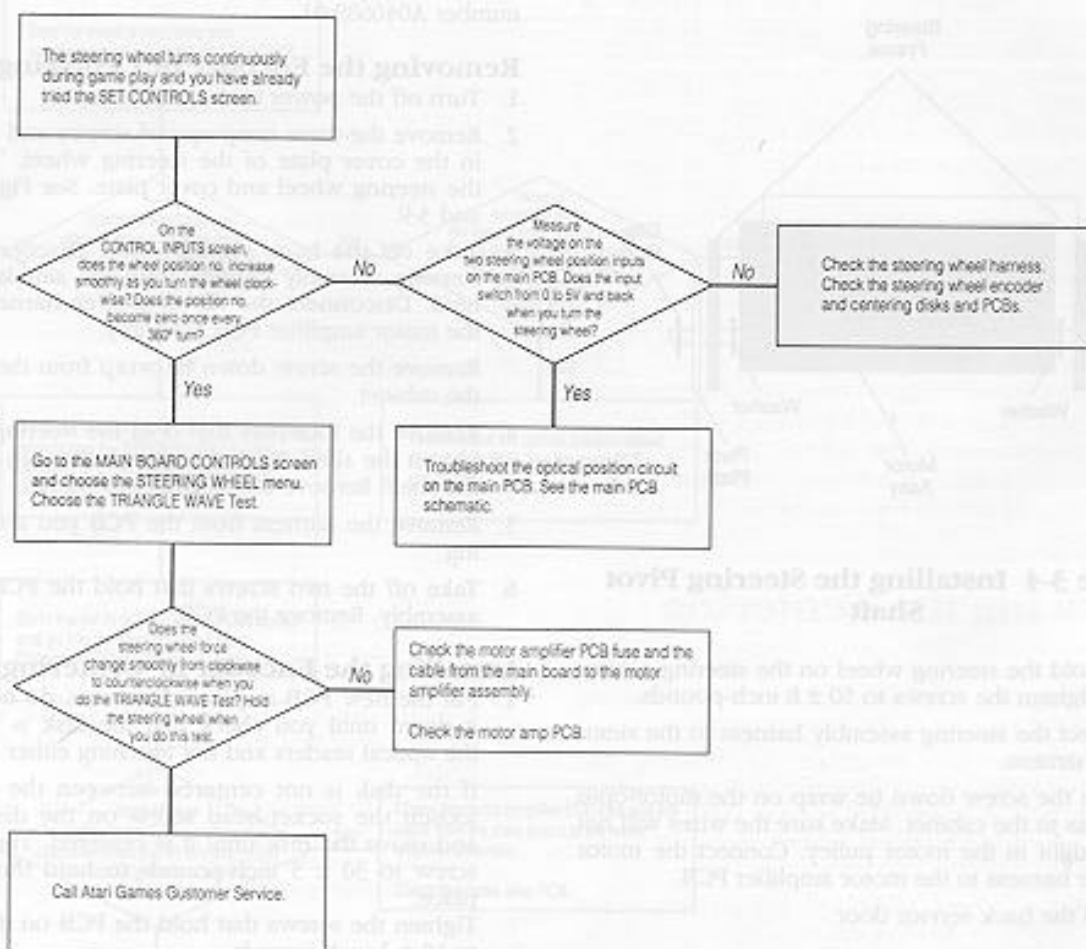

Figure 3-3 The Steering Wheel Continuously Turns in One Direction and You Have Tried the *Set Controls* Screens

7. Put oil in the fill hole on the bronze bearing on the steering wheel mounting shaft if this has not been done recently.
8. Remove the screw from the disk collar. Put the encoder disk, collar, and stiffener on the motor shaft. Make sure the hole for the socket-head screw is facing out and is over the flat of the shaft.
9. Put on the encoder PCB. Make sure the optical readers and the harness connection face down. Move the encoder disk so it is between the two readers, but does not touch them. Tighten the screws on the encoder PCB to 10 ± 3 inch-pounds.
10. Install the screw that holds the disk collar on the shaft and tighten it to 30 ± 5 inch-pounds. Make sure the encoder disk does not move on the shaft.
11. Install the harness on the encoder PCB.
12. Before you install the steering assembly back in the simulator, turn the centering disk so the single hole in the disk is between the optical readers on the PCB. This will make it much easier to correctly install the steering wheel.
13. Put the steering assembly back in the cabinet. Install the four carriage bolts through the holes in the shelf. Tightly install the fender washers and nuts on the bolts so the assembly does not move.
14. Install the steering wheel with the center spoke down. Make sure the single hole on the centering disk is between the optical reader on the centering PCB so the steering wheel will be correctly centered. Put the center cover on the steering wheel. Install the three tamperproof screws and lock washers

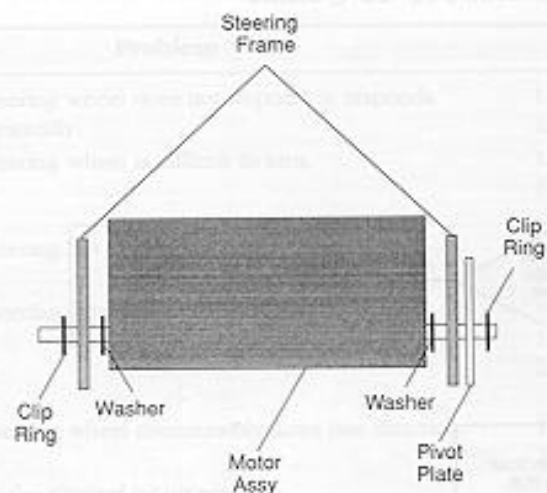

Figure 3-4 Installing the Steering Pivot Shaft

that hold the steering wheel on the steering assembly. Tighten the screws to 50 ± 8 inch-pounds.

15. Connect the steering assembly harness to the simulator harness.

Attach the screw down tie wrap on the motor-opto harness to the cabinet. Make sure the wires will not be caught in the motor pulley. Connect the motor power harness to the motor amplifier PCB.

16. Install the back service door.

NOTE

You must enter the self-test and go through the Set Controls screens because you repaired the steering assembly. Otherwise the simulator will not work correctly.

Replacing the Encoder or Centering PCB

If you are having problems with the steering, and you have determined the problem is the encoder or the centering PCB by following the troubleshooting table, Table 3-11 or the flowchart in Figures 3-3, 3-5, or 3-6, then replace the PCB.

If you are replacing the centering PCB assembly on the steering wheel shaft, part number 046691-01, you can replace it with the another centering PCB assembly or with the encoder PCB assembly, part number A046689-01. However, you must replace the encoder

PCB assembly with an encoder PCB assembly, part number A046689-01.

Removing the Encoder or Centering PCB

1. Turn off the power to the simulator.
2. Remove the three tamperproof screws and washers in the cover plate of the steering wheel. Take off the steering wheel and cover plate. See Figures 3-8 and 3-9.
3. Take off the back service door. Disconnect the steering assembly harness from the simulator harness. Disconnect the motor power harness from the motor amplifier PCB assembly.
Remove the screw down tie wrap from the side of the cabinet.
4. Remove the four nuts that hold the steering assembly on the shelf. Push the screws through holes in the shelf. Remove the steering assembly.
5. Remove the harness from the PCB you are replacing.
6. Take off the two screws that hold the PCB on the assembly. Remove the PCB.

Installing the Encoder or Centering PCB

1. Put the new PCB in place. However, do not screw it down until you check that the disk is between the optical readers and not touching either one.
If the disk is not centered between the readers, loosen the socket-head screw on the disk collar and move the disk until it is centered. Tighten the screw to 30 ± 5 inch-pounds to hold the disk in place.
Tighten the screws that hold the PCB on the frame to 10 ± 3 inch-pounds.
2. If you have not regularly oiled the bronze bearing on the steering wheel mounting shaft, put oil in the fill hole on the bearing.
3. Install the harness on the PCB.
4. Before you install the steering assembly back in the simulator, turn the centering disk so the single hole in the disk is between the optical readers on the PCB. This will make it much easier to correctly install the steering wheel.
5. Put the steering assembly back in the cabinet. Install the four carriage bolts through the holes in the shelf. Tightly install the fender washers and nuts on the bolts so the assembly does not move.
6. Install the steering wheel with the center spoke down. Make sure the single hole on the centering disk is between the optical reader on the centering PCB so the steering wheel will be correctly centered.
Put the center cover on the steering wheel. Install the three tamperproof screws and lock washers

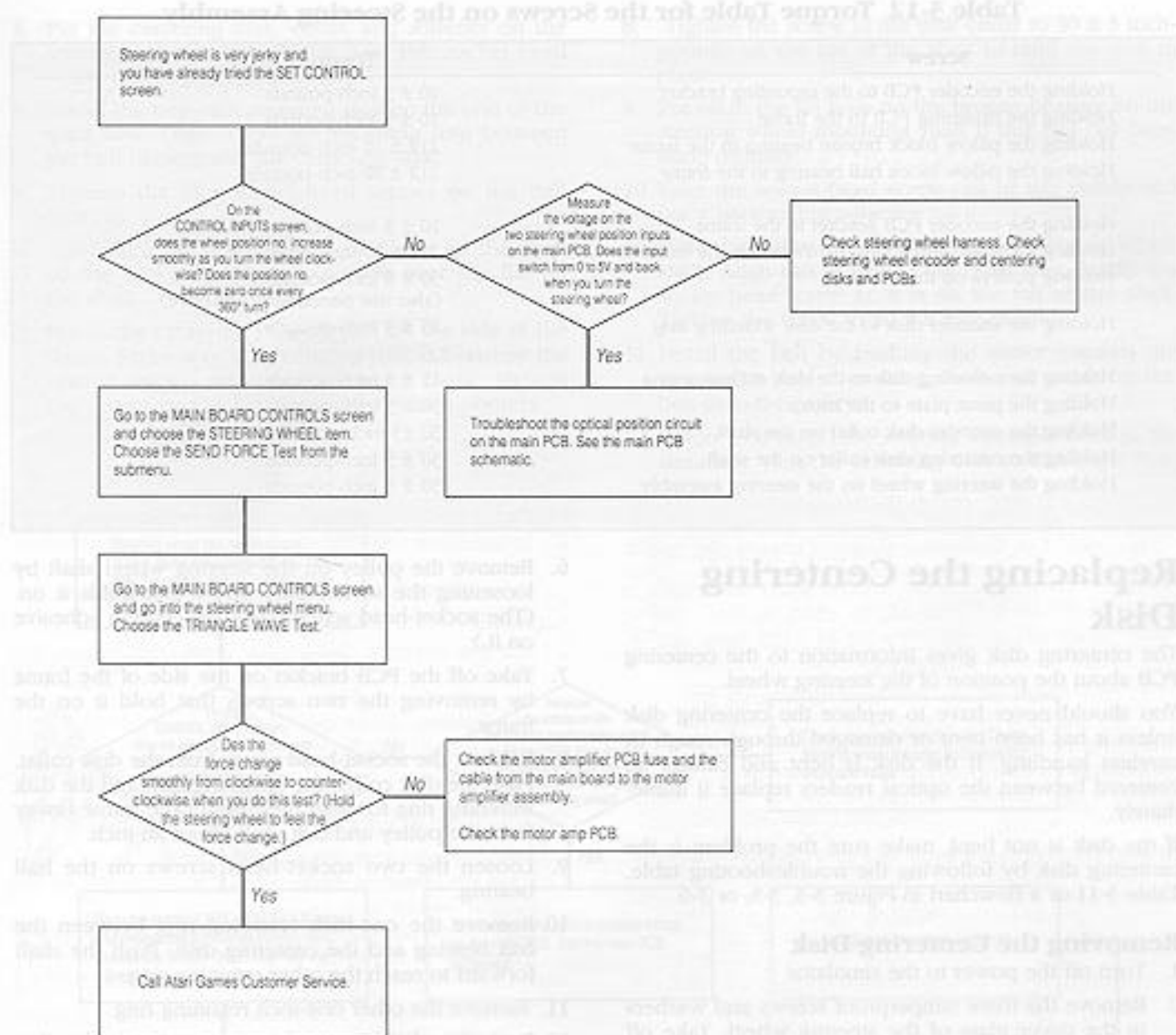

Figure 3-5 The Steering Wheel Is Jerky and You Have Tried the Set Controls Screens

that hold the steering wheel on the steering assembly. Tighten the screws to 50 ± 8 inch-pounds.

7. Connect the steering assembly harness to the simulator harness.

Attach the screw down tie wrap on the motor-opto harness to the cabinet. Make sure the wires will not be caught in the motor pulley. Connect the motor power harness to the motor amplifier PCB.

8. Install the back service door.

NOTE

You must enter the self-test and go through the Set Controls screens because you repaired the steering PCB. Otherwise the simulator will not work correctly.

Figure 3-6 The Steering Wheel Has No Feedback and You Have Tried the Set Controls Screens

Table 3-12 Torque Table for the Screws on the Steering Assembly

Screw	Torque
Holding the encoder PCB to the mounting bracket	10 ± 3 inch-pounds
Holding the centering PCB to the frame	10 ± 3 inch-pounds
Holding the pillow block bronze bearing to the frame	212 ± 20 inch-pounds
Holding the pillow block ball bearing to the frame	212 ± 20 inch-pounds
Holding the encoder PCB bracket to the frame	10 ± 3 inch-pounds
Holding the extension spring hardware on the frame	212 ± 20 inch-pounds
Holding pulleys on the shaft	50 ± 8 inch-pounds (also use penetrating adhesive)
Holding the encoder disk to the disk stiffening ring	15 ± 3 inch-pounds
Holding the centering disk to the disk stiffening ring	15 ± 3 inch-pounds
Holding the pivot plate to the motor	30 ± 5 inch-pounds
Holding the encoder disk collar on the shaft	30 ± 5 inch-pounds
Holding the centering disk collar on the shaft	30 ± 5 inch-pounds
Holding the steering wheel on the steering assembly	50 ± 8 inch-pounds

Replacing the Centering Disk

The centering disk gives information to the centering PCB about the position of the steering wheel.

You should never have to replace the centering disk unless it has been bent or damaged through rough or careless handling. If the disk is bent and cannot be centered between the optical readers replace it immediately.

If the disk is not bent, make sure the problem is the centering disk by following the troubleshooting table, Table 3-11 or a flowchart in Figure 3-3, 3-5, or 3-6.

Removing the Centering Disk

1. Turn off the power to the simulator.
2. Remove the three tamperproof screws and washers in the cover plate of the steering wheel. Take off the steering wheel and cover plate. See Figures 3-8 and 3-9.
3. Take off the back service door. Disconnect the steering assembly harness from the simulator harness. Disconnect the motor power from the motor amplifier PCB assembly.
Remove the screw down tie wrap from the side of the cabinet.
4. Remove the four nuts that hold the steering assembly on the shelf. Push the screws through holes in the shelf. Remove the steering assembly.
5. Remove the belt on the front by pushing the motor towards the steering wheel mounting shaft and by working the belt off the pulleys.

6. Remove the pulley on the steering wheel shaft by loosening the socket-head screw that holds it on. (The socket-head screw has a penetrating adhesive on it.)
7. Take off the PCB bracket on the side of the frame by removing the two screws that hold it on the frame.
8. Remove the socket-head screw from the disk collar. Push the disk collar, the centering disk and the disk stiffening ring towards the front of the frame (away from the pulley and belt end) about an inch.
9. Loosen the two socket-head screws on the ball bearing.
10. Remove the one-inch retaining ring between the ball bearing and the centering disk. Push the shaft forward to reach the other retaining ring.
11. Remove the other one-inch retaining ring.
12. Push the shaft forward and pull the disk collar, centering disk, and disk stiffening ring off.
13. Remove the three socket-head screws and washers and take apart the disk collar, the centering disk and the disk stiffening ring.

Installing the Centering Disk

1. Assemble the new centering disk with the disk collar. The slot in the disk should be 90° clockwise from the hole for the socket-head screw on the disk collar.
2. Assemble the disk collar, centering disk, and disk stiffening ring with the three socket-head screws and washers. Tighten the socket-head screws to 15 ± 3 inch-pounds.

- Put the centering disk, collar, and stiffener on the steering wheel shaft. Make sure the socket-head screw hole is towards the front.
- Install the one-inch retaining ring on the end of the shaft first. Then install the retaining ring between the ball bearing and the centering disk.
- Tighten the two socket-head screws on the ball bearing.
- Make sure the disk collar is mounted on the shaft so the socket-head screw hole is over the flat on the shaft.
- Install the centering PCB bracket on the side of the frame. Make sure the centering disk is between the optical readers and does not touch them. Tighten the screws on the bracket to 10 ± 3 inch-pounds.
- Tighten the screw in the disk collar to 30 ± 5 inch-pounds on the flat of the shaft to hold the disk in place.
- Put oil in the fill hole on the bronze bearing on the steering wheel mounting shaft if this has not been done recently.
- Take the socket-head screw out of the pulley and put a penetrating adhesive on it.
Slide the pulley on the back of the steering wheel shaft. Align this pulley to the other one. Install the socket-head screw so it is on the flat of the shaft. Tighten the screw to 50 ± 8 inch-pounds.
- Install the belt by pushing the motor towards the steering wheel mounting shaft and working the belt onto the pulleys.
- Before you install the steering assembly back in the simulator, turn the centering disk so the single hole

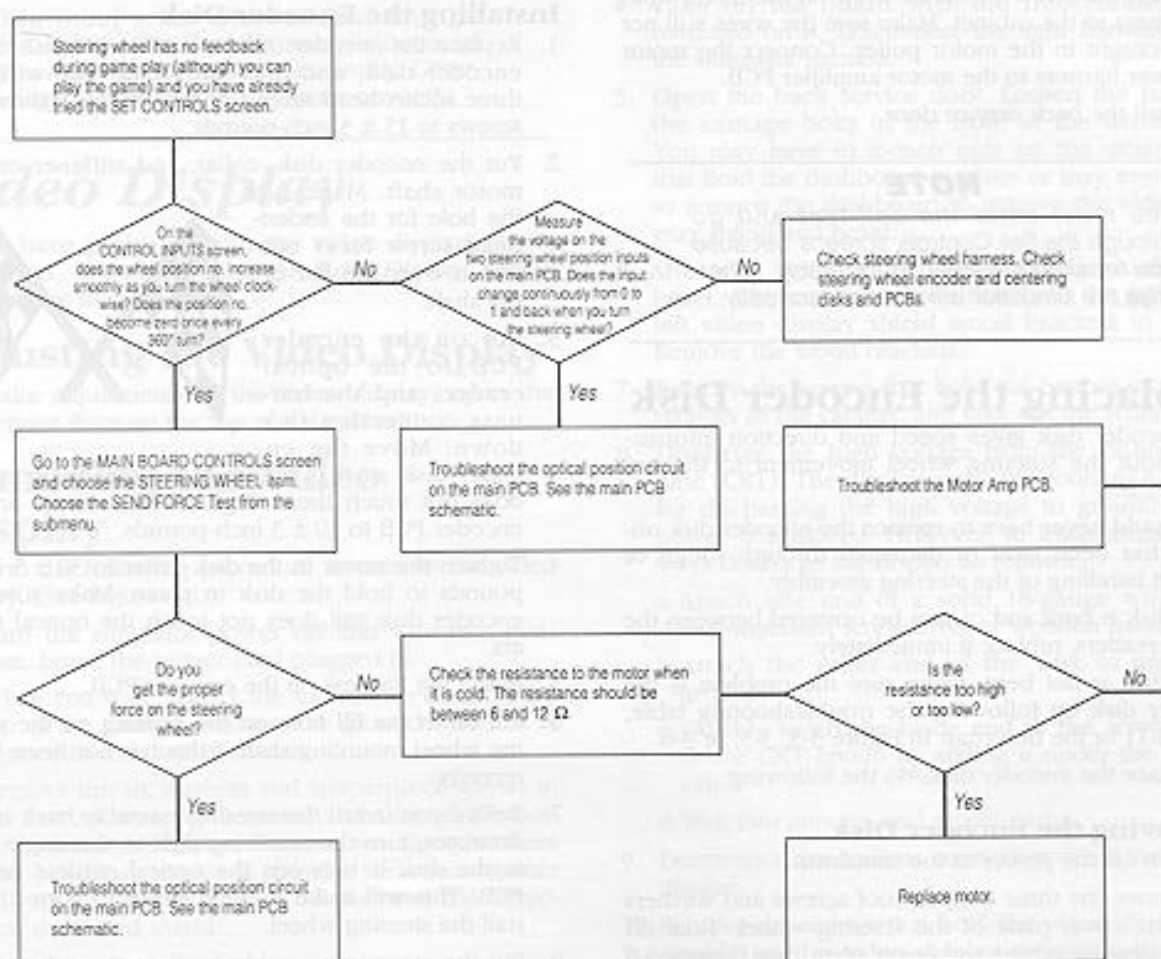

Figure 3-6 The Steering Wheel Has No Feedback and You Have Tried the Set Controls Screens

in the disk is between the optical readers on the PCB. This will make it much easier to correctly install the steering wheel.

13. Put the steering assembly back in the cabinet. Install the four carriage bolts through the holes in the shelf. Tightly install the fender washers and nuts on the bolts so the assembly does not move.
14. Install the steering wheel with the center spoke down. Make sure the single hole on the centering disk is between the optical reader on the centering PCB so the steering wheel will be correctly centered. Put the center cover on the steering wheel. Install the three tamperproof screws and lock washers that hold the steering wheel on the steering assembly. Tighten the screws to 50 ± 8 inch-pounds.
15. Connect the steering assembly harness to the simulator harness. Attach the screw down tie wrap on the motor-opto harness to the cabinet. Make sure the wires will not be caught in the motor pulley. Connect the motor power harness to the motor amplifier PCB.
16. Install the back service door.

NOTE

You must enter the self-test and go through the Set Controls screens because you repaired the steering assembly. Otherwise the simulator will not work correctly.

Replacing the Encoder Disk

The encoder disk gives speed and direction information about the steering wheel movement to the encoder PCB.

You should never have to replace the encoder disk unless it has been bent or damaged through rough or careless handling of the steering assembly.

If the disk is bent and cannot be centered between the optical readers, replace it immediately.

If the disk is not bent, make sure the problem is the encoder disk by following the troubleshooting table, Table 3-11 or the flowchart in Figure 3-3, 3-5, or 3-6.

To replace the encoder disk, do the following:

Removing the Encoder Disk

1. Turn off the power to the simulator.
2. Remove the three tamperproof screws and washers in the cover plate of the steering wheel. Take off the steering wheel and cover plate. See Figures 3-8 and 3-9.
3. Take off the back service door. Disconnect the steering assembly harness from the simulator har-

ness. Disconnect the motor power from the motor amplifier PCB assembly.

Remove the screw down tie wrap from the side of the cabinet.

4. Remove the four nuts that hold the steering assembly on the shelf. Push the screws through holes in the shelf. Remove the steering assembly.
5. Remove the harness from the encoder PCB over the encoder disk. Take off the two screws that hold the encoder PCB on the assembly. Remove the PCB.
6. Loosen the socket-head screw from the encoder disk collar. Take off the disk collar, the encoder disk and the disk stiffening ring, which are held together with three socket-head screws. Remove the three socket-head screws and washers and take apart the disk collar, the encoder disk and the disk stiffening ring.

Installing the Encoder Disk

1. Replace the encoder disk. Assemble the disk collar, encoder disk, and disk stiffening ring with the three socket-head screws and washers. Tighten the screws to 15 ± 3 inch-pounds.
2. Put the encoder disk, collar, and stiffener on the motor shaft. Make sure the hole for the socket-head screw faces out and is over the flat of the shaft.
3. Put on the encoder PCB so the optical readers and the harness connection face down. Move the encoder disk so it is between the two readers, but does not touch them. Tighten the screws on the encoder PCB to 10 ± 3 inch-pounds.
4. Tighten the screw in the disk collar to 30 ± 5 inch-pounds to hold the disk in place. Make sure the encoder disk still does not touch the optical readers.
5. Install the harness on the encoder PCB.
6. Put oil in the fill hole on the bearing on the steering wheel mounting shaft if this has not been done recently.
7. Before you install the steering assembly back in the simulator, turn the centering disk so the single hole in the disk is between the optical readers on the PCB. This will make it much easier to correctly install the steering wheel.
8. Put the steering assembly back in the cabinet. Install the four carriage bolts through the holes in the shelf. Tightly install the fender washers and nuts on the bolts so the assembly does not move.



9. Install the steering wheel with the center spoke down. Make sure the single hole on the centering disk is between the optical reader on the centering PCB so the steering wheel will be correctly centered.
Put the center cover on the steering wheel. Install the three tamperproof screws and lock washers that hold the steering wheel on the steering assembly. Tighten the screws to 50 ± 8 inch-pounds.
10. Connect the steering assembly harness to the simulator harness.
Attach the screw down tie wrap on the motor-opto harness to the cabinet. Make sure the wires will not be caught in the motor pulley. Connect the motor power harness to the motor amplifier PCB.
11. Install the back service door.

NOTE

You must enter the self-test and go through the Set Controls screens because you repaired the steering assembly. Otherwise the simulator will not work correctly.

Video Display

If you have problems with the video display, check Table 3-11, *Troubleshooting the Video Display*, before you remove the display.

Adjusting the Video Display

To make adjustments to the video display, open the top service door on the top of the cabinet.

Removing the Video Display

Perform the following procedure to remove the video display. (See Figure 4-1.)

1. Turn the simulator power off and wait two minutes. Leave the power cord plugged in.
2. While you wait, unlock the top service door on the top of the cabinet. Remove the ground wire that is clipped to the display chassis.
3. Remove the six washers and tamperproof screws in the bottom attraction retainer, and take off the bottom attraction retainer. Remove the three washers and hex-head screws in the top attraction retainer and also take this retainer off. Remove the attraction decal and shield.

WARNING

High Voltage

The video display contains lethal high voltages. To avoid injury, do not service this display until you observe all precautions necessary for working on high-voltage equipment.

X-Radiation

The video display is designed to minimize X-radiation. However, to avoid possible exposure to soft X-radiation, never modify the high-voltage circuitry.

Implosion Hazard

The cathode-ray tube may implode if struck or dropped. The shattered glass from the tube may cause injury up to six feet away. Use care when handling the display.

4. Take off the board with the fluorescent light mounted on it. Disconnect the light harness from the simulator harness.
5. Open the back service door. Loosen the nuts on the carriage bolts in the front of the dashboard. You may have to loosen nuts on the other bolts that hold the dashboard in place or may even have to remove the dashboard to remove the video display shield and bezel.
6. After you remove the video display shield and bezel, take out the screws that hold the right and left video display shield wood brackets in place. Remove the wood brackets.
7. Remove the screws that hold the bottom attraction retainer in the cabinet, and take out the retainer.
8. Discharge the high voltage from the cathode-ray tube (CRT). The display assembly contains a circuit for discharging the high voltage to ground when power is removed. However, to make certain, always discharge the display as follows:
 - a. Attach one end of a solid 18-gauge wire to a well-insulated screwdriver or wooden handle.
 - b. Attach the other end of the wire to an earth ground.
 - c. Quickly touch the blade end of the screwdriver to the CRT anode by sliding it under the anode cap.
 - d. Wait two minutes and repeat part c.
9. Disconnect the harness connectors from the video display.
10. Remove the screws that hold the video display assembly on the video display mounting brackets. The front screws have a flat washer, lock washer and a nut on them. The rear screws have only a washer and no nut.

Table 3-13 Troubleshooting the Video Display

Problem	Solution
Any problem.	Determine if the problem is with the display or the simulator hardware by performing the self-test. If you cannot perform the self-test, use the DIP switch diagnostics to narrow down the source of the problem. Check the voltage level to the video display PCB.
Convergence, purity or color problems.	Check the video display settings with the <i>Monitor Test</i> screens in the self-test.

11. Pull the video display assembly out of the cabinet. Be extremely careful.

WARNING

When you take the video display out of the cabinet, do not drop it! The display is heavy. Be careful!

Wear gloves to protect your hands from the sheet-metal edges.

Replacing the Video Display

Perform the following procedure to replace the video display in the cabinet. (See Figure 4-1.)

NOTE

If you replace the entire video display or the yoke, reverse the wires on the vertical winding before installing the display in the cabinet.

- Carefully lift the video display into the cabinet.
- Install the screws that hold the video display assembly on the video display mounting brackets. Put a flat washer, lock washer and a nut on the front screws. The rear screws have only a washer.
- Connect the power and signal harnesses to the video display.

- Install the bottom attraction retainer with the tamperproof screws. Replace the right and left video display shield brackets.
- Install the video display shield and bezel. Replace the dashboard if you removed it. Tighten all the nuts on the carriage bolts that hold the dashboard in place.
- Connect the light harness to the simulator harness. Install the board with the fluorescent light mounted on it.

NOTE

Be sure to clip the ground wire to the new display chassis.

- Install the attraction decal and shield. Install the top attraction retainer with the three hex-head screws.

NOTE

When you replace the cathode-ray tube and yoke together, adjust the brightness, size, and centering as described in the video display service manual.

Check the purity and convergence according to the service manual instructions, but adjust both only if required.

- Lock the top service door on the top of the cabinet.

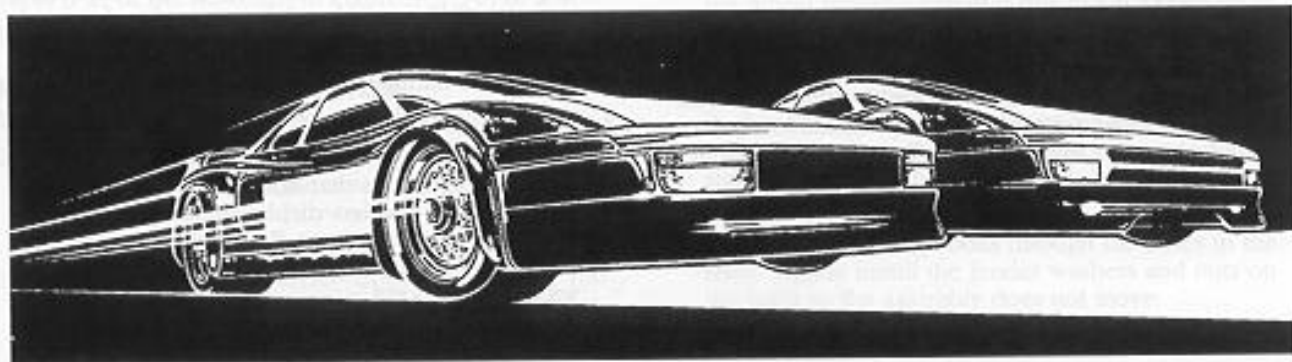

Illustrated Parts Lists

This chapter provides information you need to order parts for your game. Common hardware parts, such as screws, nuts, washers, and so on usually are not listed in the parts lists.

The parts lists (except for the PCB parts lists) are arranged alphanumerically by Atari part number. All A-prefix numbers, which are assemblies, come first. Next are part numbers with six numbers followed by a hyphen (XXXXXX-XX). Ending the list are part numbers with a two-number designation followed by a hyphen (XX-).



The PCB parts lists are arranged in alphabetical order by component. Within each section the parts are arranged numerically by part number.

When you order parts, give the part number, part name, the number of this manual, and the serial number of your game. With this information, we can fill your order rapidly and correctly. We hope this will create less downtime and more profit from your games.

Atari Games Customer Service phone numbers are listed on the inside front cover of this manual.

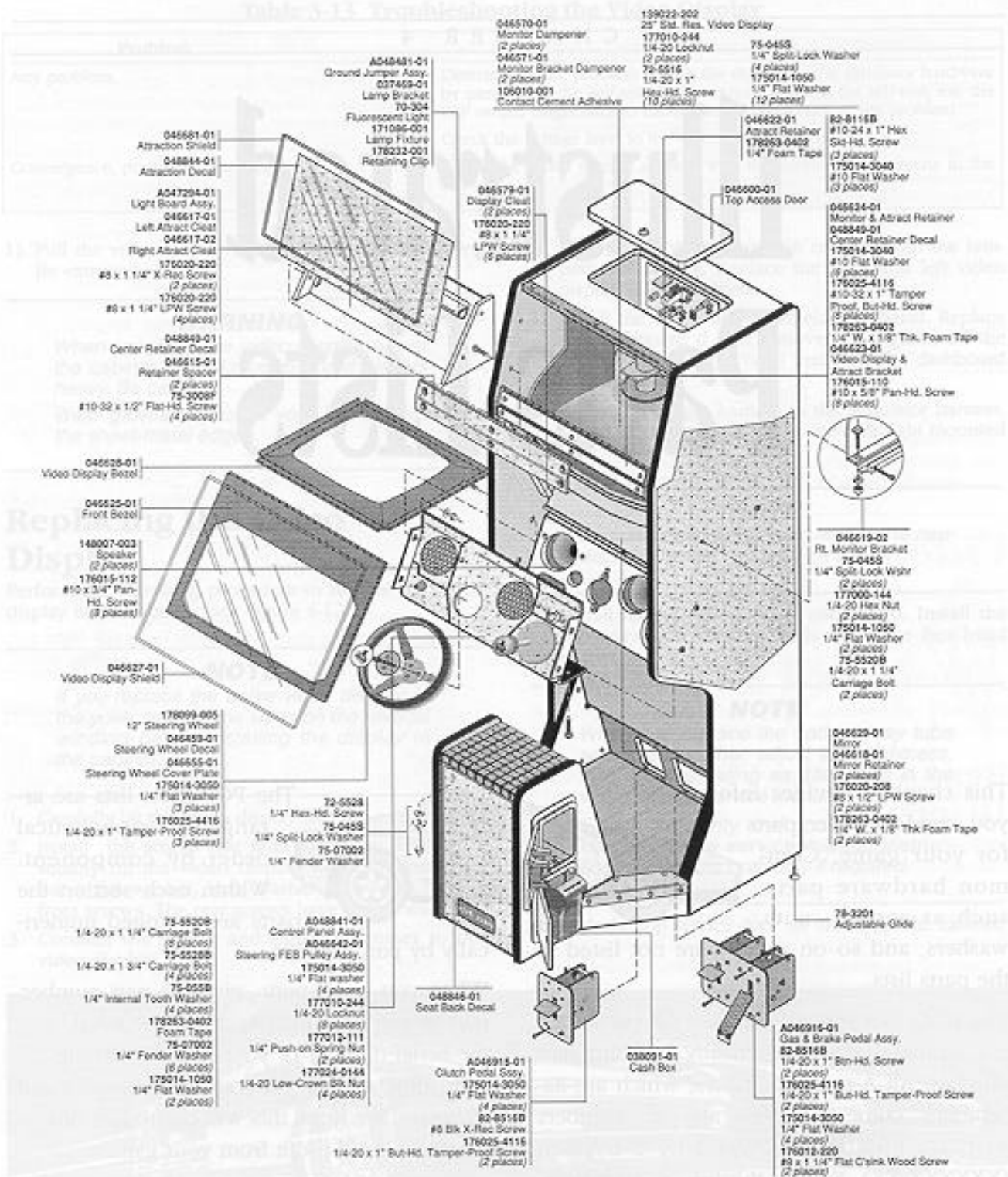

Figure 4-1 Cabinet-Mounted Assemblies, Front View
A048840-01 B

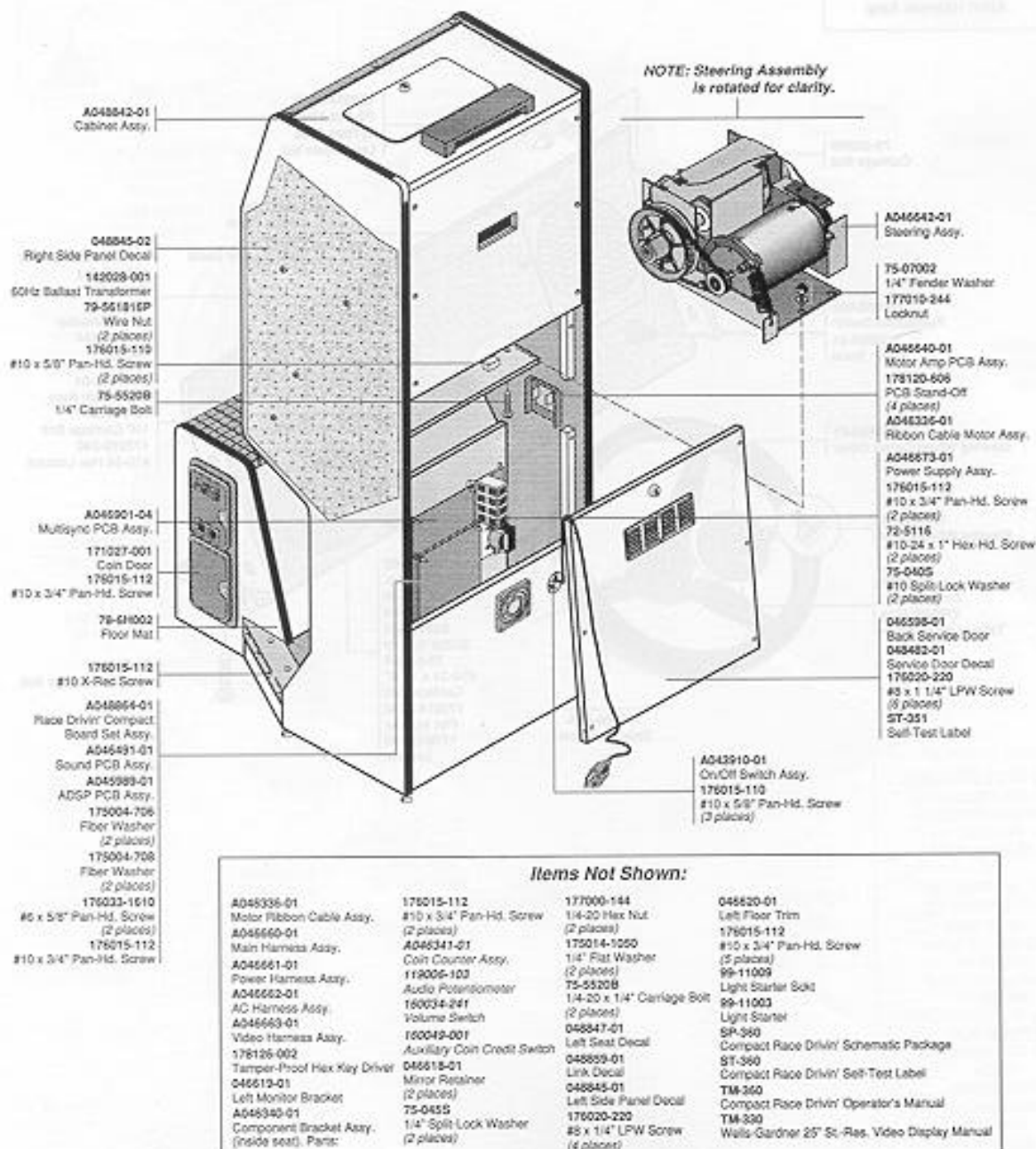
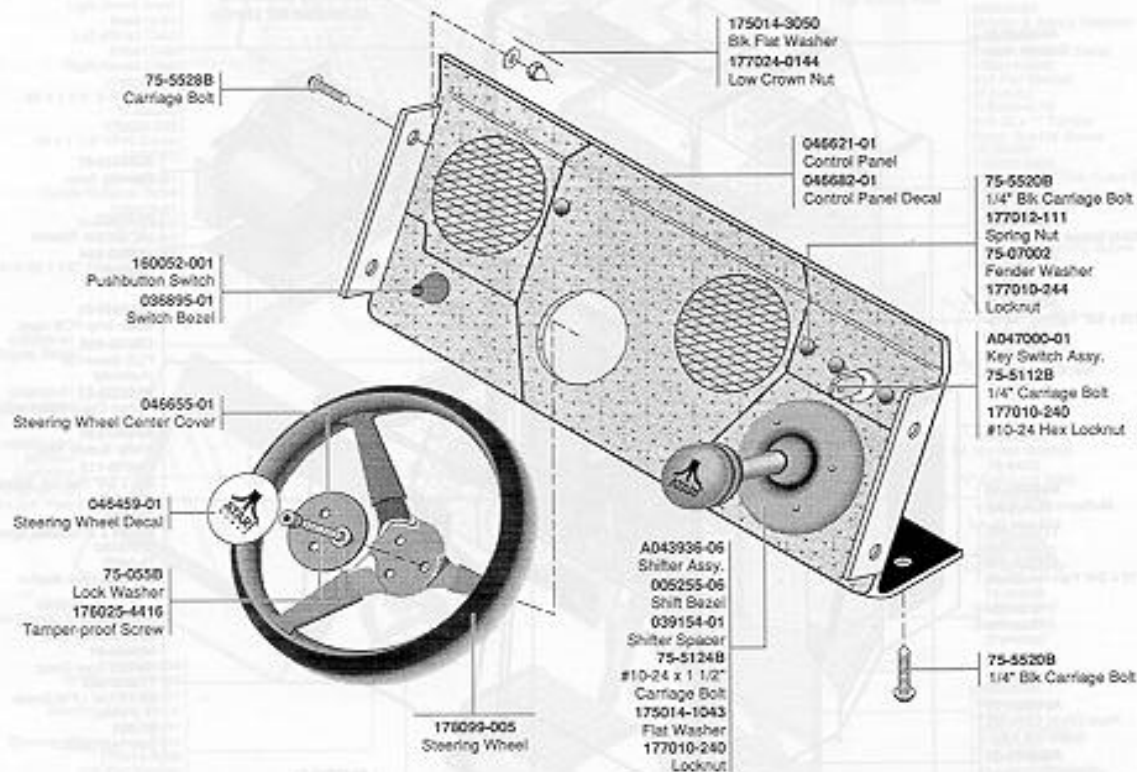

Figure 4-1 Cabinet-Mounted Assemblies, Rear View
A048840-01 B

Items Not Shown:

- A046666-01 Start Harness Assy
- A046667-01 Shifter Harness Assy
- A046668-01 Abort Harness Assy



**Figure 4-2 Dashboard Assembly
A046567-01 D**

S E T O N

Items Not Shown:
 A046642-01
 Steering Assembly Assy
 A046642-01
 Steering Assembly Assy
 A046642-01
 Steering Assembly Assy

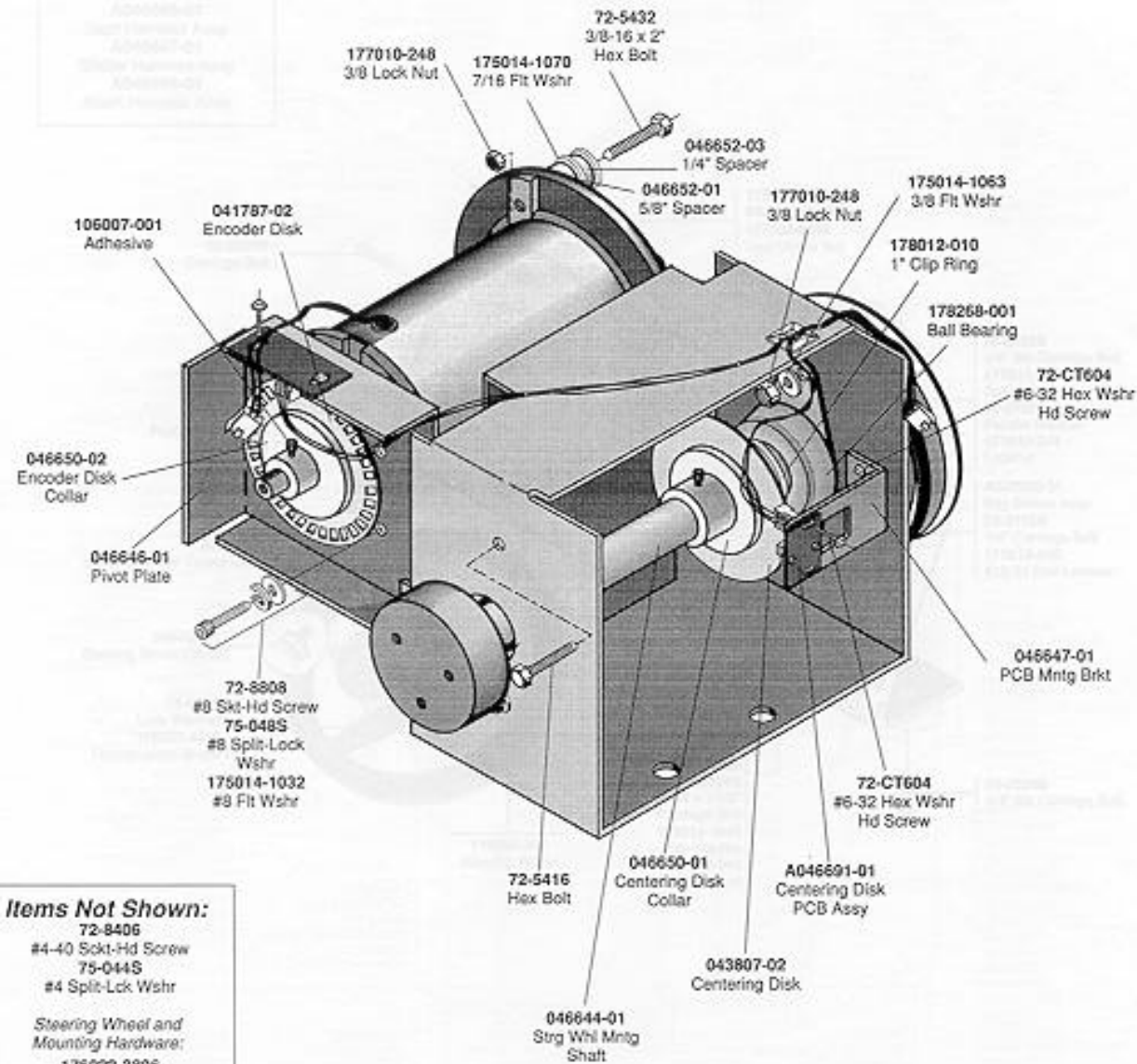

Items Not Shown:
 72-8406
 #4-40 Sckt-Hd Screw
 75-044S
 #4 Split-Lck Wshr

*Steering Wheel and
 Mounting Hardware:*
 178022-3806
 #8-32 Skt-Hd Screw
 046459-01
 Steering Whl Decal
 046655-01
 Steering Whl Center Cover
 178025-4416
 1/4-20 Blk Tamperproof
 Screw
 178099-005
 Steering Wheel
 75-055B
 1/4 Blk Lock Wshr

Figure 4-3 Steering Assembly, Front View
 A046642-01 D

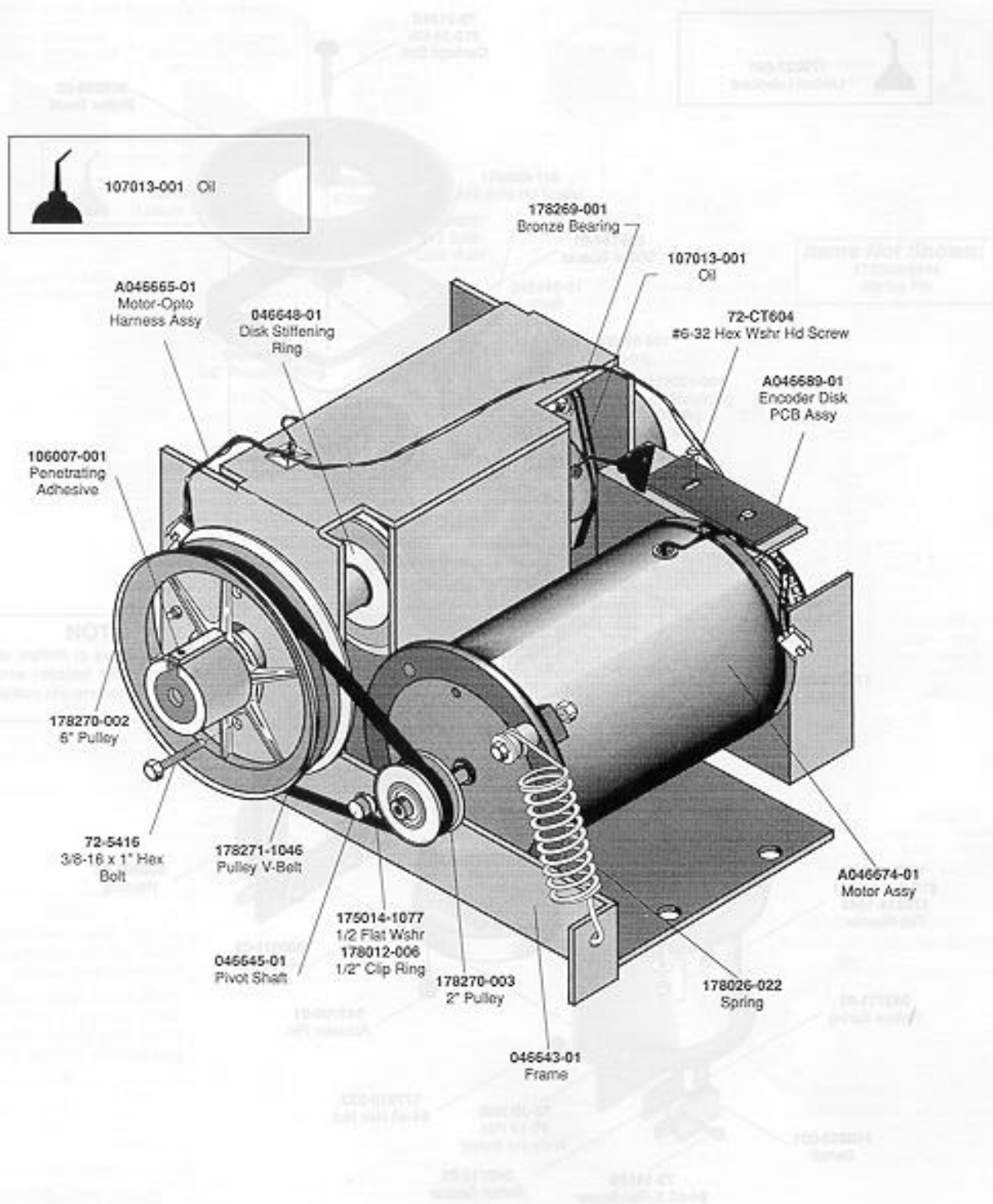

Figure 4-3 Steering Assembly, Rear View
A046642-01 D

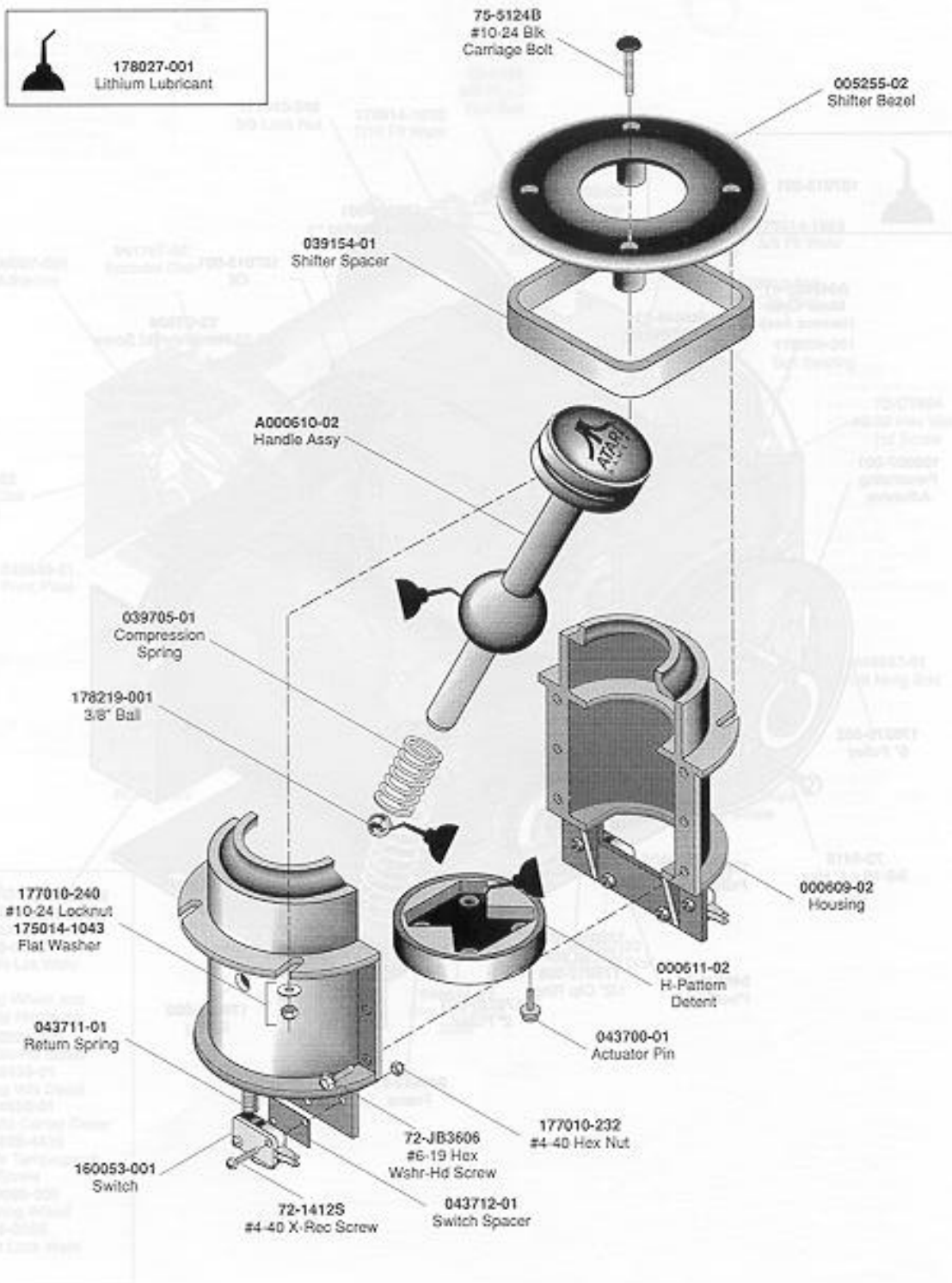

Figure 4-4 Shifter Assembly
A043936-06 A

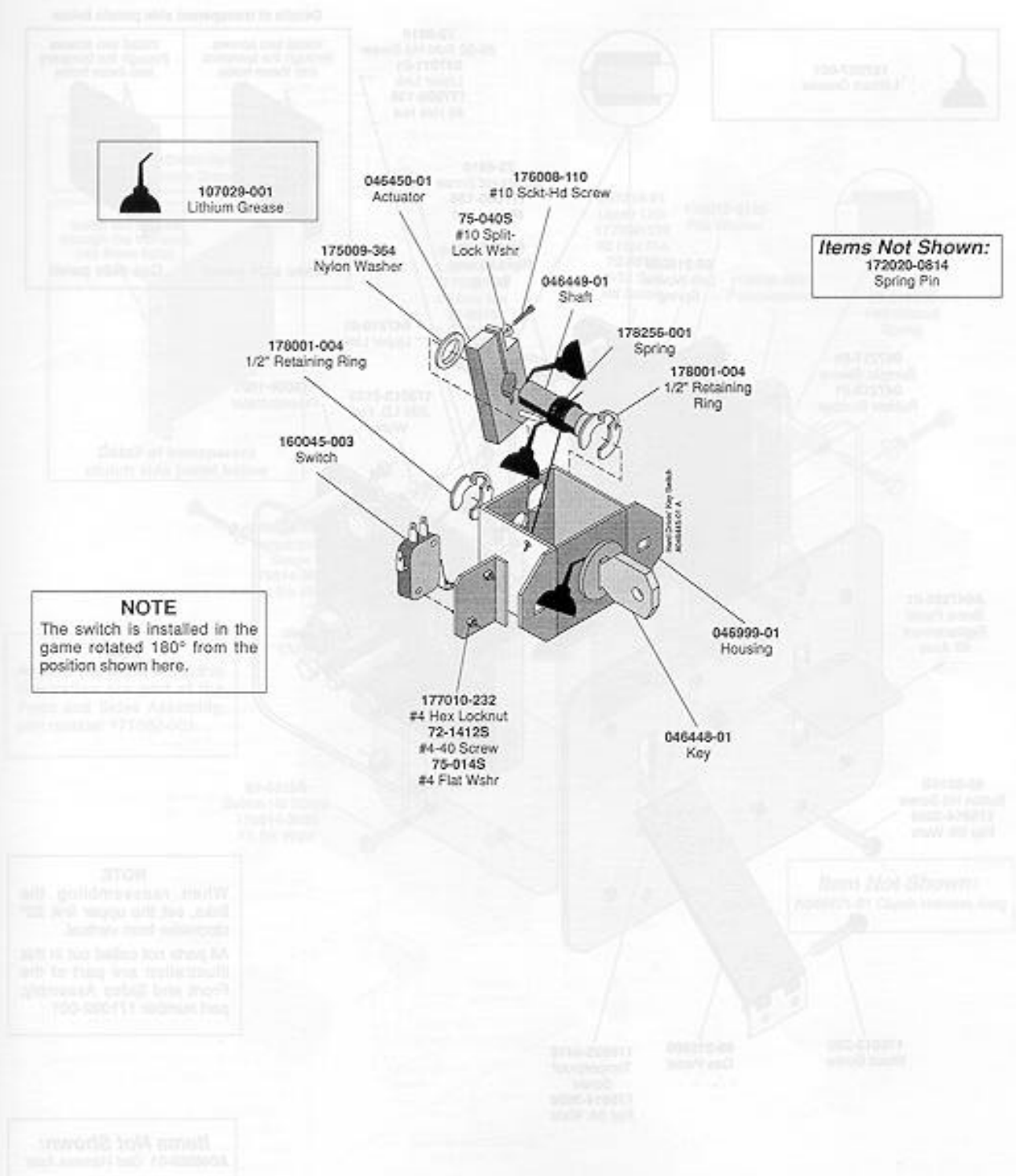

Figure 4-5 Key Switch Assembly
A047000-01 A

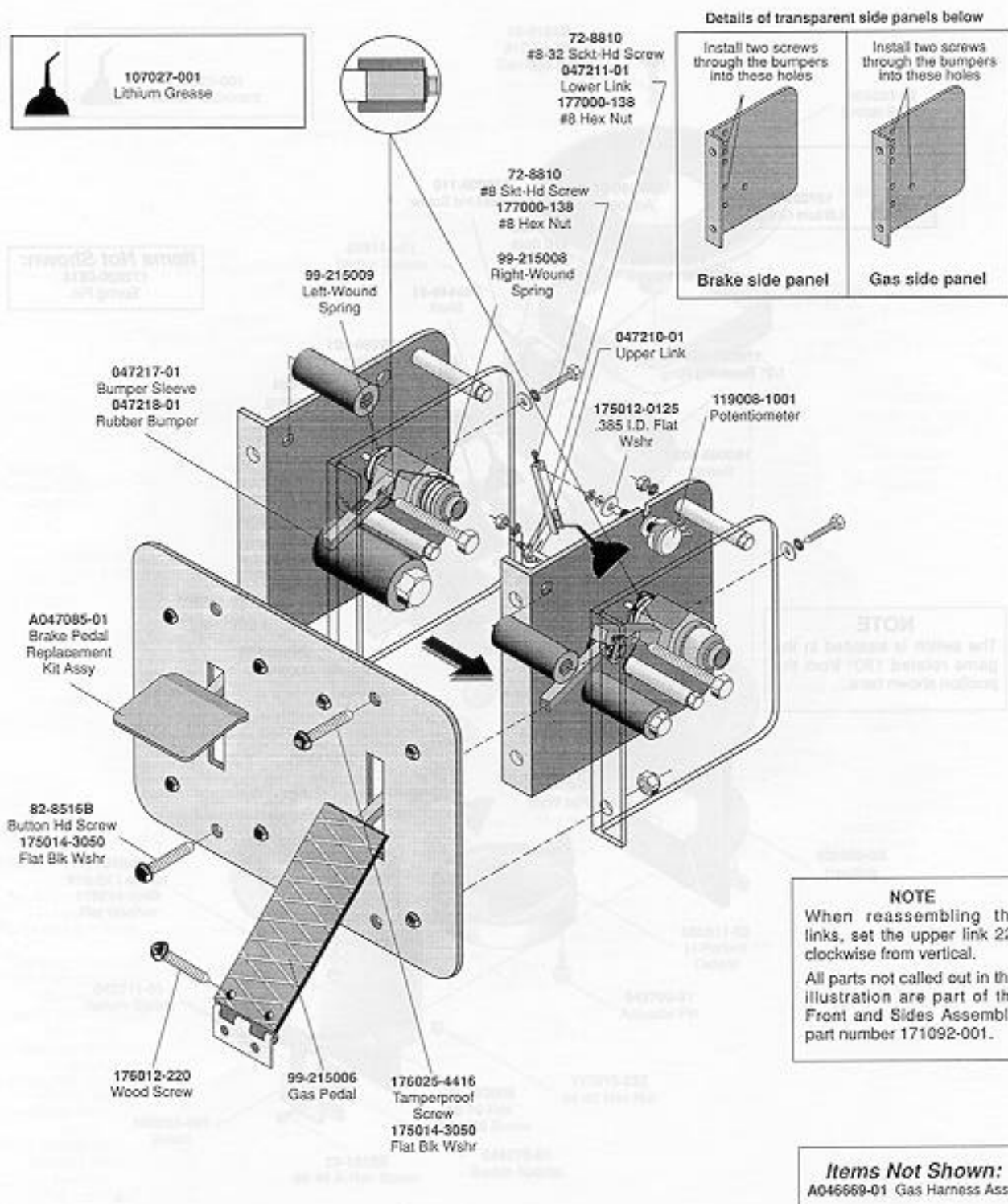
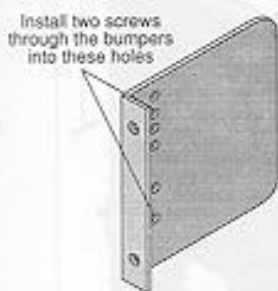
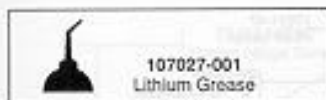

Figure 4-6 Brake and Gas Pedal Assembly
A046916-01 B



Detail of transparent clutch side panel below

047211-01
Lower Link
177000-138
#8 Hex Nut
72-8810
#8-32 Sckt-Hd Screw

047210-01
Upper Link
177000-138
#8 Hex Nut
72-8810
#8-32 Sckt-Hd Screw

175012-0125
Flat Washer

119008-1001
Potentiometer

99-215009
Left-Wound Spring

176025-4416
Tamperproof Screw
175014-3050
Flat Blk Wshr

99-215006
Clutch Pedal

99-215008
Right-Wound Spring

82-8516B
Button Hd Screw
175014-3050
Flat Blk Wshr

NOTE
All parts not called out in this illustration are part of the Front and Sides Assembly, part number 171092-001.

Item Not Shown:
A046671-01 Clutch Harness Assy

NOTE
The manufacturer's instructions for the use of this product are contained in the Owner's Manual, which is available from the manufacturer. The manufacturer's name and address are: The Clutch Control Ltd., 10000-100th Ave. S.W., Surrey, B.C. V4N 1V1, Canada. Telephone: (604) 273-1111.

Figure 4-7 Clutch Pedal Assembly
A046915-01 B

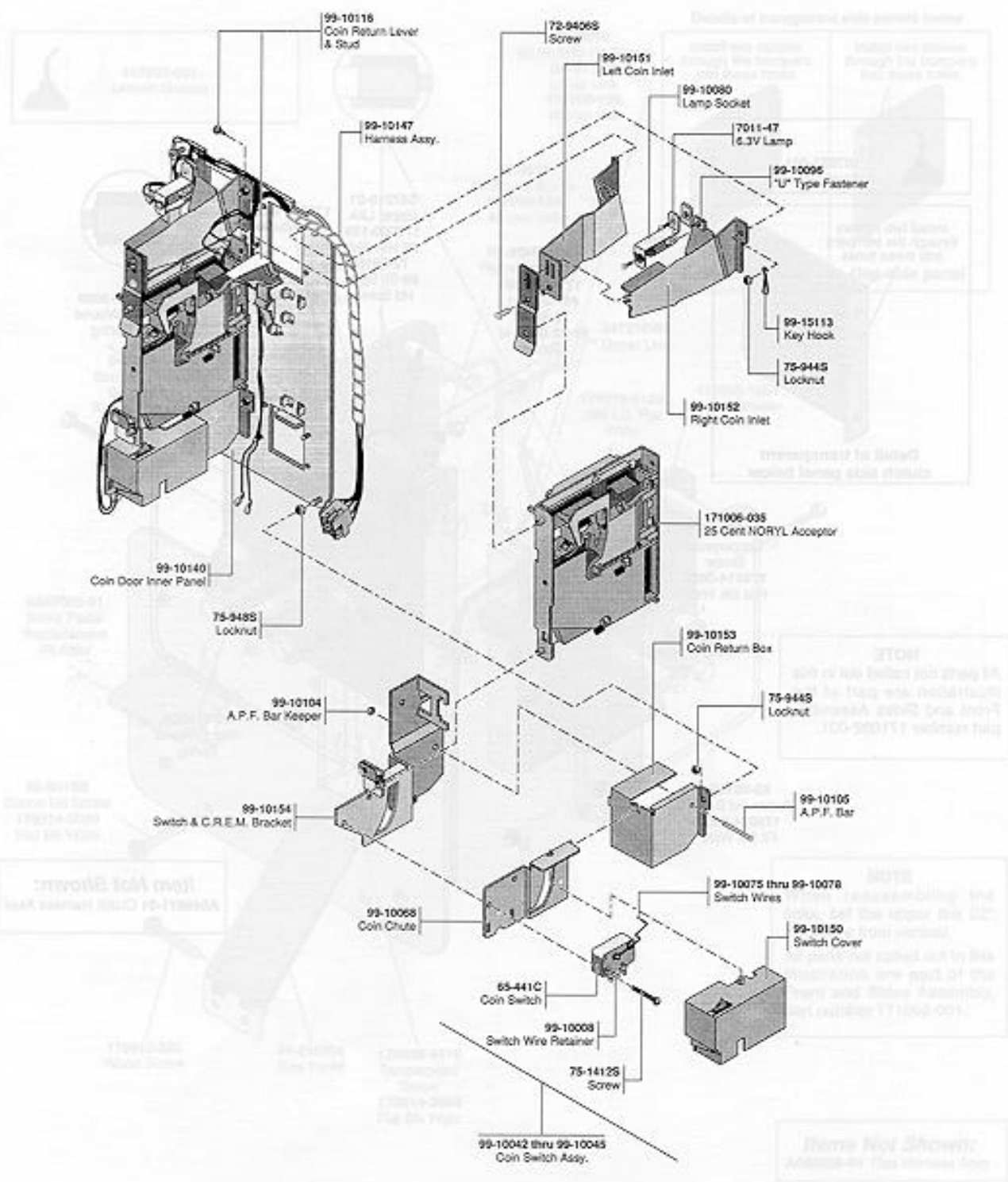

Figure 4-8 Coin Acceptors, Inc. Coin Door Assembly
171027-001 A

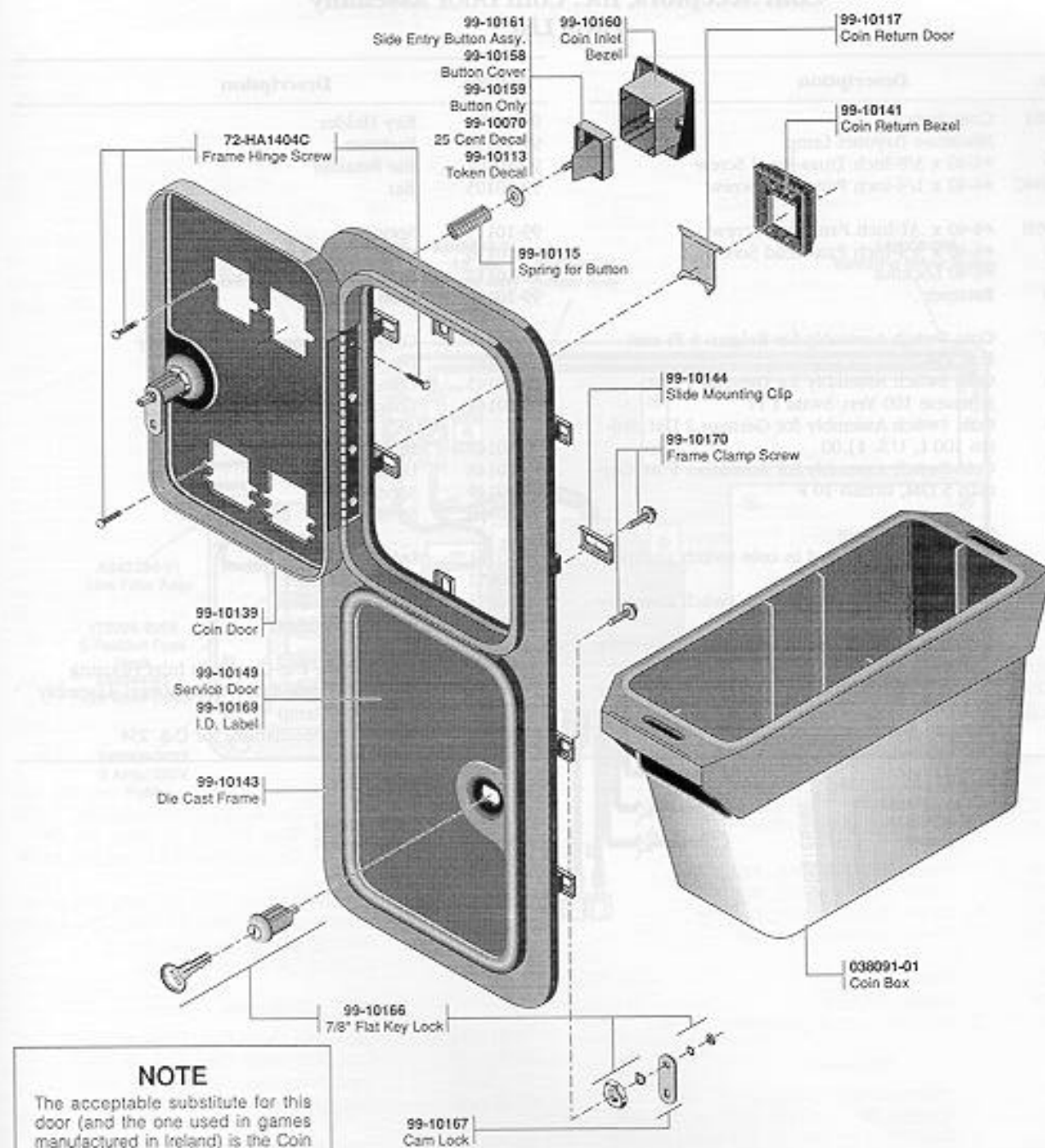

Figure 4-8 Coin Acceptors, Inc. Coin Door Assembly, Continued
171027-001 A

Part No.	Description	Part No.	Description	Part No.	
179231-002	2-Position Terminal Block	A046346-02	15" Wht Jumper Assy	A046346-01	15" Blk Jumper Assy
A043387-01	Jumper Assy	149005-002	Switching Power Supply		
A042384-01	Line Filter Assy				
179225-2205	5-Position Fuse Block				
034544-01	Fuse Block Cover				
146008-3022	3 Amp, 250V Fuse				
146008-2022	2 Amp, 250V Fuse				
142051-001	Transformer				
A044431-02	APU PCB Assy				

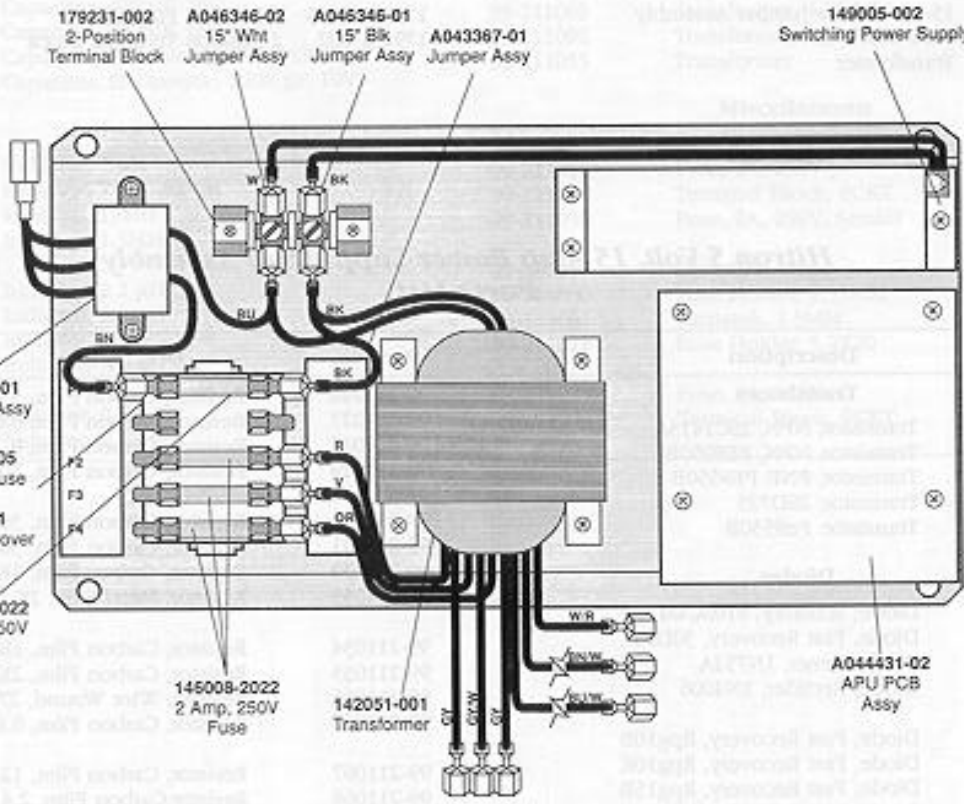

Figure 4-9 Power Supply Assembly
A046673-01 A

Power Supply Assembly Parts List

Part No.	Description	Part No.	Description
A042384-01	Line Filter Assembly	146008-2022	2 Amp, 250V Slow Blow Fuse
A043367-01	Jumper Assembly	146008-3022	3 Amp, 250V Slow Blow Fuse
A044431-02	APU PCB Assembly (See Figure 4-11)	149005-002	5 Volt, 15 Amp Hitron Switching Power Supply (See Below)
A046346-01	15-Inch Black Jumper Assembly		
A046346-02	15-Inch White Jumper Assembly	179225-2205	5 Position Fuse Block
034544-01	Fuse Block Cover	179231-002	2 Position Terminal Block
142051-001	Transformer		

Hitron 5 Volt, 15 Amp Power Supply Sub-Assembly Parts List

Part No.	Description	Part No.	Description
Transistors			
99-211002	Transistor, NPN, 2SC1413A	99-211026	Resistor, Carbon Film, 330 Ohm, 5%, 1/4W
99-211003	Transistor, NPN, PE8050B	99-211027	Resistor, Carbon Film, 5.6 Ohm, 5%, 1/4W
99-211004	Transistor, PNP, PE8550B	99-211028	Resistor, Carbon Film, 8.2 Ohm, 5%, 1/4W
99-211062	Transistor, 2SD725	99-211029	Resistor, Carbon Film, 10 Ohm, 5%, 1/4W
99-211063	Transistor, Pe8550B		
Diodes			
99-211005	Diode, Schottky, S10SC4M	99-211030	Resistor, Carbon Film, 39 Ohm, 5%, 1/4W
99-211006	Diode, Fast Recovery, 30DF1	99-211031	Resistor, Carbon Film, 56 Ohm, 5%, 1/4W
99-211007	Diode, Zener, 1N752A	99-211032	Resistor, Carbon Film, 1K Ohm, 5%, 1/4W
99-211008	Diode, Rectifier, 1N4006	99-211033	Resistor, Metal Film, 2K Ohm, 2%, 1/4W
99-211009	Diode, Fast Recovery, Rpg10B		
99-211010	Diode, Fast Recovery, Rpg10K	99-211034	Resistor, Carbon Film, 180K Ohm, 5%, 1W
99-211011	Diode, Fast Recovery, Rpg15B	99-211035	Resistor, Carbon Film, 2K Ohm, 5%, 1/4W
99-211012	Diode, Switching, 1N4148	99-211065	Resistor, Wire Wound, 27 Ohm, 5%, 2W
		99-211066	Resistor, Carbon Film, 6.8 Ohm, 5%, 1/2W
99-211064	Diode, S155C4M		
99-211076	Diode, 31DQ04	99-211067	Resistor, Carbon Film, 12 Ohm, 5%, 1/4W
99-211013	Rectifier, Silicon Controlled, S2800	99-211068	Resistor, Carbon Film, 2.4 Ohm, 5%, 1/2W
Resistors			
99-211014	Potentiometer, Trimming, 3K Ohm	99-211077	Resistor, 470 Ohm, 1/2W, 5%
99-211015	Resistor, Wire Wound, 50 Ohm, 5%, 2W	99-211078	Resistor, 120K Ohm, 1W, 5%
99-211016	Resistor, Wire Wound, 150 Ohm, 5%, 2W	Capacitors	
99-211017	Resistor, Wire Wound, 33 Ohm, 5%, 2W	99-211036	Capacitor, Metal Film, 0.047 μ F, 250V
99-211018	Resistor, Wire Wound, 0.47 Ohm, 5%, 2W	99-211037	Capacitor, Metal Film, 0.22 μ F, 100V
99-211019	Resistor, Wire Wound, 120 Ohm, 5%, 2W	99-211038	Capacitor, Metal Film, 0.1 μ F, 400V
99-211020	Thermistor, 0.5 Ohm, 5%, 5W	99-211039	Capacitor, Metal Film, 0.022 μ F, 100V
99-211021	Resistor, 2.2K Ohm, 2%, 1/4W		
99-211022	Resistor, Carbon Film, 330 Ohm, 5%, 1/2W	99-211040	Capacitor, Ceramic, 1800 PF, 2KV, Z5V
99-211023	Resistor, Carbon Film, 270 Ohm, 5%, 1/2W	99-211041	Capacitor, Ceramic, 0.01 μ F, 1KV, Z5U
99-211024	Resistor, Carbon Film, 470 Ohm, 5%, 1/4W	99-211042	Capacitor, Ceramic, 0.001 μ F, 2KV
99-211025	Resistor, Carbon Film, 47 Ohm, 5%, 1/4W	99-211043	Capacitor, Ceramic, 470 PF, 1KV, Z5P
		99-211044	Capacitor, Electrolytic, 470 μ F, 25V
		99-211045	Capacitor, Electrolytic, 220 μ F, 25V
		99-211046	Capacitor, Electrolytic, 100 μ F, 200V
		99-211047	Capacitor, Electrolytic, 1000 μ F, 25V
		99-211048	Capacitor, Electrolytic, 2200 μ F, 16V
		99-211049	Capacitor, Ceramic, 4700 μ F, 400V

Hitron 5 Volt, 15 Amp Power Supply Sub-Assembly Parts List

Part No.	Description	Part No.	Description
99-211069	Capacitor, Electrolytic, 2200 μ F, 16V	99-211088	Inductor, 60 MH
99-211070	Capacitor, Electrolytic, 220 μ F, 25V		
99-211079	Capacitor, De7100F22M		Transformers
99-211080	Capacitor, 1000 μ F, 35V	99-211075	Transformer, Power
99-211081	Capacitor, 470 μ F, 25V	99-211083	Transformer, Power
99-211082	Capacitor, 220 μ F, 16V	99-211089	Transformer, 4.75 MH
99-211090	Capacitor, Ceramic, 1000 PF, 2KV	99-211092	Transformer
99-211091	Capacitor, Electrolytic, 2200 μ F, 10V	99-211055	Transformer
	Inductors		Miscellaneous
99-211050	Inductor, 7 μ H	99-211001	Regulator, UA431AWC
99-211051	Inductor, 7 μ H, 35MM	99-211056	Fuse, 2A, 250V
99-211052	Inductor, 15MH	99-211057	Terminal Block, 8CKT
99-211053	Inductor, 1.5MH	99-211058	Fuse, 2A, 250V, Semko
99-211054	Inductor, 2.2 μ H	99-211059	Heatsink
99-211071	Inductor, 9.8 μ H	99-211060	Fuse Holder, 6.35MM
99-211084	Inductor, 8 μ H	99-211061	Heatsink, 1.5MM
99-211085	Inductor, 9.8 μ H	99-211072	Fuse Holder, 5.2X20
99-211086	Inductor, 0.75MH	99-211073	Fuse, 2A, 125V
99-211087	Inductor, 2.2 μ H	99-211074	Terminal Block, 9CKT

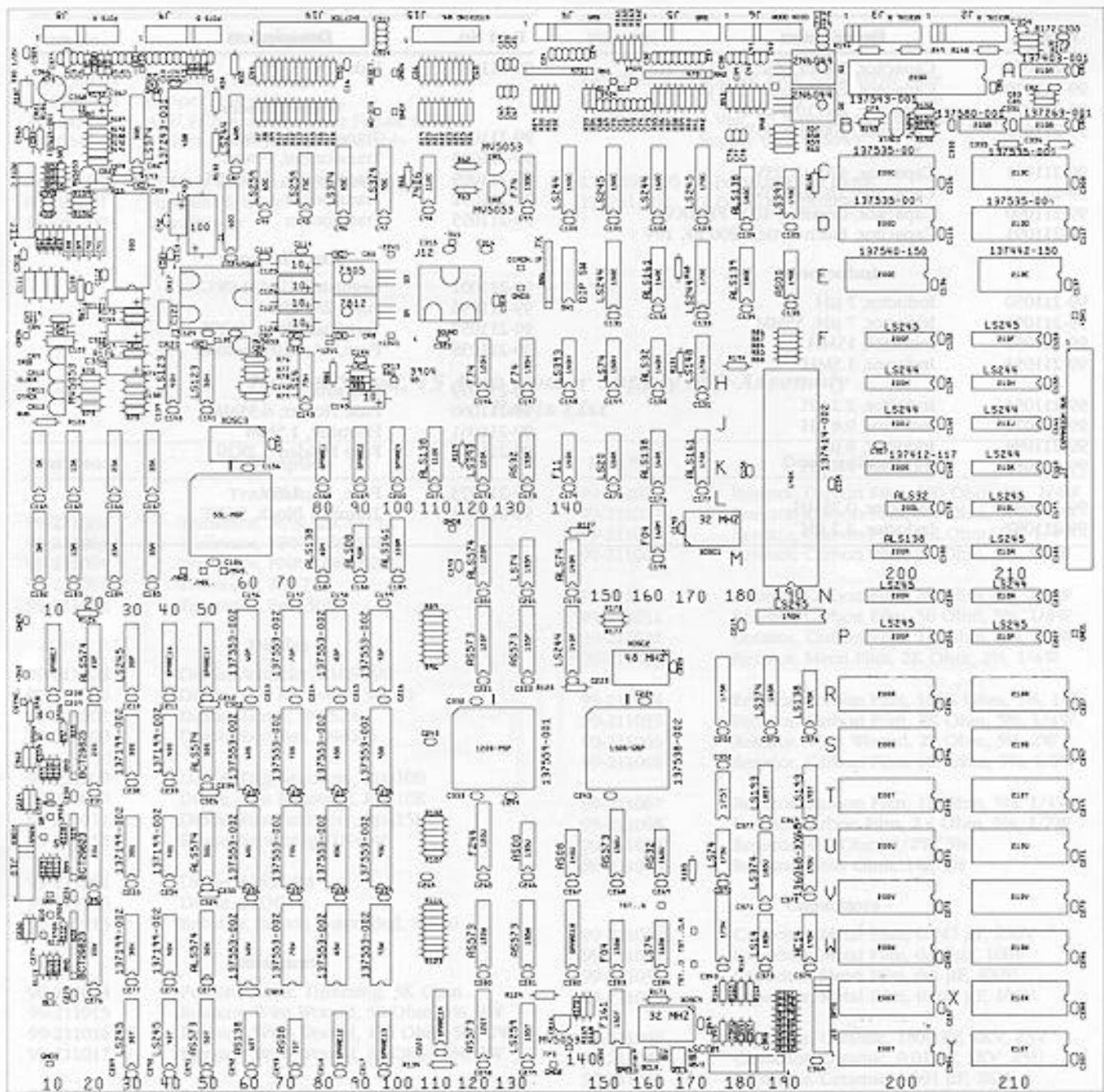

**Figure 4-10 Race Drivin' Compact Multisync PCB Assembly
A046901-04 B**

Race Drivin' Compact Multisync PCB Assembly Parts List

Designator	Description	Part No.	Designator	Description	Part No.
Integrated Circuits					
5K	Integrated Circuit, 4464, 64K x 4, DRAM	137546-003	70Y	Integrated Circuit, 74AS08	137484-001
5M	Integrated Circuit, 74F244	137502-001	75C	Integrated Circuit, 74LS259	137137-001
15B	Integrated Circuit, AD711KN	137614-001	75H	Integrated Circuit, 74LS14	137056-001
15K	Integrated Circuit, 4464, 64K X 4, DRAM	137546-003	80M	Integrated Circuit, 74ALS138	137517-001
15M	Integrated Circuit, 74ALS245	137440-001	85C	Integrated Circuit, 74LS374	137144-001
20P	Integrated Circuit, 74ALS574	137548-001	85P, 85S	Integrated Circuit, VRAM, 64Kx4, 150 nsec (Acceptable substitute is part no. 137553-001, Integrated Circuit, VRAM, 64Kx4, 120 nsec.)	137553-002
20S, 20U	Integrated Circuit, 74BCT29823	137513-003	85U, 85W	Integrated Circuit, VRAM, 64Kx4, 150 nsec (Acceptable substitute is part no. 137553-001, Integrated Circuit, VRAM, 64Kx4, 120 nsec.)	137553-002
20W	Integrated Circuit, 74BCT29823	137513-003	90M	Integrated Circuit, 74ALS08	137460-001
25K	Integrated Circuit, 4464, 64K x 4, DRAM	137546-003	95C	Integrated Circuit, 74LS374	137144-001
25M	Integrated Circuit, 74AS573	137547-001	95P, 95S	Integrated Circuit, VRAM, 64Kx4, 150 nsec (Acceptable substitute is part no. 137553-001, Integrated Circuit, VRAM, 64Kx4, 120 nsec.)	137553-002
30B	Integrated Circuit, 74LS374	137144-001	95U, 95W	Integrated Circuit, VRAM, 64Kx4, 150 nsec (Acceptable substitute is part no. 137553-001, Integrated Circuit, VRAM, 64Kx4, 120 nsec.)	137553-002
30P	Integrated Circuit, 74LS245	137134-001	100M	Integrated Circuit, 74ALS161	137470-001
30S, 30U	Integrated Circuit, 2149, 45 nsec	137199-002	110C	Integrated Circuit, 7406	137052-001
30W	Integrated Circuit, 2149, 45 nsec	137199-002	110K	Integrated Circuit, 74ALS138	137517-001
30Y	Integrated Circuit, 74LS245	137134-001	120H	Integrated Circuit, 74F74	137436-001
35K	Integrated Circuit, 4464, 64K x 4, DRAM	137546-003	120K	Integrated Circuit, 74LS393	137146-001
35M	Integrated Circuit, 74ALS245	137440-001	120M	Integrated Circuit, 74ALS574	137548-001
40H	Integrated Circuit, 74LS123	137268-001	120P	Integrated Circuit, 74AS573	137547-001
40S, 40U	Integrated Circuit, 2149, 45 nsec	137199-002	120S-PS	Integrated Circuit, 34012-50	137559-001
40W	Integrated Circuit, 2149, 45 nsec	137199-002	120U	Integrated Circuit, 74F244	137502-001
40Y	Integrated Circuit, 74LS245	137134-001	120W, 120Y	Integrated Circuit, 74AS573	137547-001
45B	Integrated Circuit, ADC0809	137243-001	135C, 135H	Integrated Circuit, 74F74	137436-001
50H	Integrated Circuit, 74LS123	137268-001	135K	Integrated Circuit, 74AS32	137487-001
50S, 50U	Integrated Circuit, 74ALS574	137548-001	135M	Integrated Circuit, 74LS74	137023-001
50W	Integrated Circuit, 74ALS574	137548-001	135P	Integrated Circuit, 74AS573	137547-001
50Y	Integrated Circuit, 74AS573	137547-001	135U	Integrated Circuit, 74AS00	137480-001
55L-MSP	Integrated Circuit, 34010-50	137538-002	135W	Integrated Circuit, 74AS573	137547-001
60B	Integrated Circuit, 74LS244	137038-001	135Y	Integrated Circuit, 74LS259	137137-001
60P, 60S	Integrated Circuit, VRAM, 64Kx4, 150 nsec (Acceptable substitute is part no. 137553-001, Integrated Circuit, VRAM, 64Kx4, 120 nsec.)	137553-002	140C	Integrated Circuit, 74LS244	137038-001
60U, 60W	Integrated Circuit, VRAM, 64Kx4, 150 nsec (Acceptable substitute is part no. 137553-001, Integrated Circuit, VRAM, 64Kx4, 120 nsec.)	137553-002	140H	Integrated Circuit, 74LS393	137146-001
60Y	Integrated Circuit, 74AS138	137522-001	140K	Integrated Circuit, 74F11	137583-001
65C	Integrated Circuit, 74LS259	137137-001	140M	Integrated Circuit, 74ALS74	137156-001
70P, 70S	Integrated Circuit, VRAM, 64Kx4, 150 nsec (Acceptable substitute is part no. 137553-001, Integrated Circuit, VRAM, 64Kx4, 120 nsec.)	137553-002	140P	Integrated Circuit, 74LS244	137038-001
70U, 70W	Integrated Circuit, VRAM, 64Kx4, 150 nsec (Acceptable substitute is part no. 137553-001, Integrated Circuit, VRAM, 64Kx4, 120 nsec.)	137553-002	140U	Integrated Circuit, 74AS08	137484-001
			150C	Integrated Circuit, 74LS245	137134-001
			150E	Integrated Circuit, 74LS244	137038-001
			150H	Integrated Circuit, 74LS74	137023-001
			150K	Integrated Circuit, 74LS20	137060-001

Race Drivin' Compact Multisync PCB Assembly, Continued Parts List

Designator	Description	Part No.	Designator	Description	Part No.
150S-GSP	Integrated Circuit, 34010-50	137538-002	200Y	Integrated Circuit, EPROM	136078-1016
150U	Integrated Circuit, 74AS573	137547-001	205B	Integrated Circuit, 4066B	137580-001
150W	Integrated Circuit, 74F04	137437-001	210A	Integrated Circuit, MC1488	137403-001
150Y	Integrated Circuit, 74F161	137343-001	210B	Integrated Circuit, MC1489AL	137263-001
160C	Integrated Circuit, 74LS244	137038-001	210C, 210D	Integrated Circuit, RAM, 8Kx8, 150 nsec	137535-006
160E	Integrated Circuit, 74ALS161	137470-001	210E	Integrated Circuit, 48202-15, RAM	137442-150
160H	Integrated Circuit, 74ALS32	137464-001	210F	Integrated Circuit, 74LS245	137134-001
160K	Integrated Circuit, 74ALS138	137517-001	210H, 210J	Integrated Circuit, 74LS244	137038-001
160M	Integrated Circuit, 74F04	137437-001	210K	Integrated Circuit, 74LS244	137038-001
160U	Integrated Circuit, 74AS32	137487-001	210L, 210M	Integrated Circuit, 74LS245	137134-001
160W	Integrated Circuit, 74LS74	137023-001	210N	Integrated Circuit, 74LS244	137038-001
170C	Integrated Circuit, 74LS245	137134-001	210P	Integrated Circuit, 74LS245	137134-001
170E	Integrated Circuit, 74LS244	137038-001	210R	Integrated Circuit, EPROM	136078-1001
170H	Integrated Circuit, 74LS148	137417-001	210S	Integrated Circuit, EPROM	136078-1003
170K	Integrated Circuit, 74ALS161	137470-001	210T	Integrated Circuit, EPROM	136078-1005
175U	Integrated Circuit, 74LS74	137023-001	210U	Integrated Circuit, EPROM	136078-1007
180C	Integrated Circuit, 74ALS138	137517-001	210V	Integrated Circuit, EPROM	136078-1009
180E	Integrated Circuit, 74ALS139	137467-001	210W	Integrated Circuit, EPROM	136078-1011
185R	Integrated Circuit, 74LS374	137144-001	210X	Integrated Circuit, EPROM	136078-1013
185T	Integrated Circuit, 74LS193	137128-001	210Y	Integrated Circuit, EPROM	136078-1015
185U	Integrated Circuit, 74LS374	137144-001	Capacitors		
185W	Integrated Circuit, 74LS14	137056-001	C1	Capacitor, 100 μ F, 35 V, Electrolytic	124000-107
190C	Integrated Circuit, 74LS393	137146-001	C2	Capacitor, .01 μ F, 50 V, Ceramic	122002-103
190E	Integrated Circuit, 74AS00	137480-001	C3-C14	Capacitor, .1 μ F, 50 V, Ceramic	122002-104
190K	Integrated Circuit, 68010	137414-002	C16	Capacitor, .1 μ F, 50 V, Ceramic	122002-104
190N	Integrated Circuit, 74LS245	137134-001	C19-C21	Capacitor, .1 μ F, 50 V, Ceramic	122002-104
195R	Integrated Circuit, 74LS138	137177-001	C24-C43	Capacitor, .1 μ F, 50 V, Ceramic	122002-104
195T	Integrated Circuit, 74LS193	137128-001	C44-C63	Capacitor, .001 μ F, 50 V, \pm 10%	122015-102
195U	Integrated Circuit, PROM, 82S123	136068-1168	C65-C78	Capacitor, .1 μ F, 50 V, Ceramic	122002-104
195W	Integrated Circuit, 74HC14	137605-001	C79	Capacitor, 10 pF, 100 V, Ceramic	122016-100
200A	Integrated Circuit, 68681	137543-001	C80-C82	Capacitor, .1 μ F, 50 V, Ceramic	122002-104
200C, 200D	Integrated Circuit, RAM, 8Kx8, 150 nsec	137535-006	C83, C84	Capacitor, 100 pF, 100 V, Ceramic	122016-101
200E	Integrated Circuit, 48T02-15, RAM	137540-150	C85-C87	Capacitor, .1 μ F, 50 V, Ceramic	122002-104
200F	Integrated Circuit, 74LS245	137134-001	C94-C106	Capacitor, .1 μ F, 50 V, Ceramic	122002-104
200H, 200J	Integrated Circuit, 74LS244	137038-001	C114-C117	Capacitor, .1 μ F, 50 V, Ceramic	122002-104
200K	Integrated Circuit, SLAPSTIC	137412-117	C123, C124	Capacitor, .1 μ F, 50 V, Ceramic	122002-104
200L	Integrated Circuit, 74ALS32	137464-001	C125-C128	Capacitor, 10 μ F, 35 V, Electrolytic	124000-106
200M	Integrated Circuit, 74ALS138	137517-001	C129-C137	Capacitor, .1 μ F, 50 V, Ceramic	122002-104
200N, 200P	Integrated Circuit, 74LS245	137134-001	C138, C139	Capacitor, 1000 pF, 100 V, Ceramic	122016-102
200R	Integrated Circuit, EPROM	136078-1002	C140, C141	Capacitor, .1 μ F, 50 V, Ceramic	122002-104
200S	Integrated Circuit, EPROM	136078-1004	C142	Capacitor, .22 μ F, 50 V, Ceramic	122015-224
200T	Integrated Circuit, EPROM	136078-1006	C143, C144	Capacitor, .1 μ F, 50 V, Ceramic	122002-104
200U	Integrated Circuit, EPROM	136078-1008	C145	Capacitor, 10 μ F, 35 V, Electrolytic	124000-106
200V	Integrated Circuit, EPROM	136078-1010	C146-C189	Capacitor, .1 μ F, 50 V, Ceramic	122002-104
200W	Integrated Circuit, EPROM	136078-1012	C193-C202	Capacitor, .1 μ F, 50 V, Ceramic	122002-104
200X	Integrated Circuit, EPROM	136078-1014	C204-C227	Capacitor, .1 μ F, 50 V, Ceramic	122002-104

Race Drivin' Compact Multisync PCB Assembly, Continued Parts List

Designator	Description	Part No.	Designator	Description	Part No.
C228	Capacitor, .001 μ F, 50 V, \pm 10%	122015-102	Crystals		
C229	Capacitor, 47 pF, 100 V, Ceramic	122016-470	XOSC1	Oscillator, 32 MHz	144008-002
C230-238	Capacitor, .1 μ F, 50 V, Ceramic	122002-104	XOSC2	Crystal, 48 MHz, Oscillator Module	144008-003
C243-249	Capacitor, .1 μ F, 50 V, Ceramic	122002-104	XOSC4	Oscillator, 32 MHz	144008-002
C250	Capacitor, 47 pF, 100 V, Ceramic	122016-470	XTAL1	Crystal, 3.6864, Standup	144000-011
C251-259	Capacitor, .1 μ F, 50 V, Ceramic	122002-104	Diodes		
C264-273	Capacitor, .1 μ F, 50 V, Ceramic	122002-104	CR1, CR2	Diode, MV5053, Light Emitting	131027-002
C274	Capacitor, 47 pF, 100 V, Ceramic	122016-470	CR5	Diode, 1N4002	131048-002
C275-293	Capacitor, .1 μ F, 50 V, Ceramic	122002-104	CR6	Diode, MV5053, Light Emitting	131027-002
C298, C299	Capacitor, .1 μ F, 50 V, Ceramic	122002-104	CR7, CR8	Diode, 1N4002	131048-002
C306-309	Capacitor, .1 μ F, 50 V, Ceramic	122002-104	CR9-CR12	Diode, MV5053, Light Emitting	131027-002
C315-320	Capacitor, .1 μ F, 50 V, Ceramic	122002-104	CR13	Diode, 1N4002	131048-002
C323-326	Capacitor, 10 pF, 100 V, Ceramic	122016-100	CR14	Diode, MV5053, Light Emitting	131027-002
C330-333	Capacitor, .1 μ F, 50 V, Ceramic	122002-104	CR18	Diode, 1N4002	131048-002
C335, C336	Capacitor, 100 pF, 100 V, Ceramic	122016-101	CR21	Diode, 1N4740A, 10 V, \pm 5%, Zener	131009-213
C341, C342	Capacitor, .1 μ F, 50 V, Ceramic	122002-104	CR22	Diode, MV5053, Light Emitting	131027-002
C349-352	Capacitor, .1 μ F, 50 V, Ceramic	122002-104	CR23	Diode, 1N4002	131048-002
C354, C355	Capacitor, .1 μ F, 50 V, Ceramic	122002-104	Transistors		
C358	Capacitor, .1 μ F, 50 V, Ceramic	122002-104	Q1, Q2	Transistor, 2N6044	133042-001
C359, C360	Capacitor, .001 μ F, 50 V, \pm 10%	122015-102	Q3	Integrated Circuit, 7905	137581-001
C361-363	Capacitor, 1000 pF, 100 V, Ceramic	122016-102	Q4	Integrated Circuit, 7812	137597-001
C364, C365	Capacitor, .1 μ F, 50 V, Ceramic	122002-104	Q5	Transistor, 2N3904	133041-001
C366	Capacitor, 470 μ F, 16 V, Electrolytic, Radial	123004-477	Q6	Transistor, 2N3906	133040-001
C367	Capacitor, .1 μ F, 50 V, Ceramic	122002-104	Q7	Transistor, 2N3904	133041-001
C368	Capacitor, 10 μ F, 20 V, Tantalum	127002-106	Q8	Transistor, 2N3906	133040-001
C369-377	Capacitor, .1 μ F, 50 V, Ceramic	122002-104	Q9	Transistor, 2N3904	133041-001
C378	Capacitor, .001 μ F, 50 V, \pm 10%	122015-102	Q10	Transistor, 2N3906	133040-001
C379	Capacitor, .1 μ F, 50 V, Ceramic	122002-104	Q11-Q13	Transistor, 2N3904	133041-001
Connectors			Resistors		
BCLK	Connector, Rept, 2 Ckt	179178-002	R1-R26	Resistor, 100 Ω , \pm 5%, 1/4 W	110000-101
BCLK	Connector, 4 Ckt, Header, .100 Ctr	179177-004	R29-R45	Resistor, 1 K Ω , \pm 5%, 1/4 W	110000-102
J1	Connector, 12 Circuit, Header, .250 Ctr	179069-012	R46-R48	Resistor, 470 Ω , \pm 5%, 1/4 W	110000-471
J2-J6	Connector, 11 Circuit, Header, .100 Ctr	179118-011	R49-R54	Resistor, 4.7 K Ω , \pm 5%, 1/4 W	110000-472
J7	Connector, Card Edge Header, 60 Circuit, 2 Ctr	179153-060	R55	Resistor, 100 Ω , \pm 5%, 1/4 W	110000-101
J8-J10	Connector, 11 Circuit, Header, .100 Ctr	179118-011	R57-R60	Resistor, 1 K Ω , \pm 5%, 1/4 W	110000-102
J12	Connector, 9 Circuit, Header, .250 Ctr	179069-009	R61	Resistor, 4.7 K Ω , \pm 5%, 1/4 W	110000-472
J13	Connector, 11 Circuit, Header, .100 Ctr	179118-011	R62, R63	Resistor, 220 Ω , \pm 5%, 1/4 W	110000-221
J14	Connector, 26 Circuit, Header, .1 x .1 Dual	179261-026	R68	Resistor, 1 K Ω , \pm 5%, 1/4 W	110000-102
J15	Connector, 16 Circuit, Header, .1 x .1 Dual	179261-016	R70-R73	Resistor, 220 Ω , \pm 5%, 1/4 W	110000-221
SPEED	Connector, Rept, 2 Ckt	179178-002	R74, R75	Resistor, 10 K Ω , \pm 5%, 1/4 W	110000-103
SPEED	Connector, 6 Ckt, Header, .100 Ctr	179177-006	R76	Resistor, 220 Ω , \pm 5%, 1/4 W	110000-221
VCLK	Connector, Rept, 2 Ckt	179178-002	R77, R78	Resistor, 4.7 K Ω , \pm 5%, 1/4 W	110000-472
VCLK	Connector, 6 Ckt, Header, .100 Ctr	179177-006	R79	Resistor, 47 K Ω , \pm 5%, 1/4 W	110000-473
			R80, R81	Resistor, 1 K Ω , \pm 5%, 1/4 W	110000-102
			R82, R83	Resistor, 470 Ω , \pm 5%, 1/4 W	110000-471
			R84-R88	Resistor, 10 K Ω , \pm 5%, 1/4 W	110000-103
			R89-R96	Resistor, 33 Ω , \pm 5%, 1/4 W	110000-330

Race Drivin' Compact Multisync PCB Assembly, Continued Parts List

Designator	Description	Part No.	Designator	Description	Part No.
R98-101	Resistor, 100 Ω , $\pm 5\%$, 1/4 W	110000-101	R187	Resistor, 330 Ω , $\pm 5\%$, 1/2 W	110001-331
R102-107	Resistor, 33 Ω , $\pm 5\%$, 1/4 W	110000-330	R188	Resistor, 1 K Ω , $\pm 5\%$, 1/4 W	110000-102
R109-111	Resistor, 100 Ω , $\pm 5\%$, 1/4 W	110000-101	R189	Resistor, 2.2 M Ω , $\pm 5\%$, 1/4 W	110000-225
R113-115	Resistor, 100 Ω , $\pm 5\%$, 1/4 W	110000-101	R190	Resistor, 10 K Ω , $\pm 5\%$, 1/4 W	110000-103
R116-123	Resistor, 33 Ω , $\pm 5\%$, 1/4 W	110000-330	R191	Resistor, 1 K Ω , $\pm 5\%$, 1/4 W	110000-102
R124	Resistor, 220 Ω , $\pm 5\%$, 1/4 W	110000-221	R192	Resistor, 270 K Ω , $\pm 5\%$, 1/4 W	110000-274
R125-131	Resistor, 1 K Ω , $\pm 5\%$, 1/4 W	110000-102	R193, R194	Resistor, 1 K Ω , $\pm 5\%$, 1/4 W	110000-102
R132	Resistor, 4.7 K Ω , $\pm 5\%$, 1/4 W	110000-472	R197	Resistor, 1 K Ω , $\pm 5\%$, 1/4 W	110000-102
R134	Resistor, 1 K Ω , $\pm 5\%$, 1/4 W	110000-102	RN1, RN2	Resistor Network, 470x9, $\pm 5\%$, 1/8 W, SIP (10 Pin)	118010-471
R145, R146	Resistor, 10 K Ω , $\pm 5\%$, 1/4 W	110000-103	RN3-RN5	Resistor Network, R2R Ladder	118015-001
R147, R148	Resistor, 100 K Ω , $\pm 5\%$, 1/4 W	110000-104	RN6	Resistor Network, 4.7Kx9, $\pm 5\%$, 1/8 W, SIP (10 Pin)	118010-472
R149, R150	Resistor, 10 K Ω , $\pm 5\%$, 1/4 W	110000-103	Sockets		
R151, R152	Resistor, 220 Ω , $\pm 5\%$, 1/4 W	110000-221		Socket, 20 Pin, .300"	179259-020
R155	Resistor, 0, $\pm 5\%$, 1/4 W	110005-001		Socket, 24 Pin, .600"	179257-024
R160, R161	Resistor, 10 K Ω , $\pm 5\%$, 1/4 W	110000-103		Socket, 28 Pin, .600"	179257-028
R162, R163	Resistor, 150 Ω , $\pm 5\%$, 1/4 W	110000-151		Socket, 40 Pin, .600"	179257-040
R168-171	Resistor, 10 K Ω , $\pm 5\%$, 1/4 W	110000-103		Socket, 64 Pin, .900"	179256-064
R172, R173	Resistor, 10 Ω , $\pm 5\%$, 1/4 W	110000-100		Socket, 68 Pin	179237-068
R177, R178	Resistor, 100 Ω , $\pm 5\%$, 1/4 W	110000-101	Miscellaneous		
R182-184	Resistor, 10 K Ω , $\pm 5\%$, 1/4 W	110000-103	SW1	Switch, 8-Position DIP Test Point	160031-008 179051-001
R185	Resistor, 1 K Ω , $\pm 5\%$, 1/4 W	110000-102			
R186	Resistor, 82 Ω , $\pm 5\%$, 1/4 W	110000-820			

Race Drivin' Compact Multiple PCB Assembly, Continued

Designator	Description	Part No.	Designator	Description	Part No.
R05-101	Resistor, 100 Ω, 25%, 1/4 W	110000-101	R167	Resistor, 200 Ω, 25%, 1/4 W	110000-201
R102-107	Resistor, 25 Ω, 25%, 1/4 W	110000-105	R168	Resistor, 1 K Ω, 25%, 1/4 W	110000-100
R108-111	Resistor, 100 Ω, 25%, 1/4 W	110000-101	R169	Resistor, 2.2 K Ω, 25%, 1/4 W	110000-225
R112-115	Resistor, 100 Ω, 25%, 1/4 W	110000-101	R170	Resistor, 10 K Ω, 25%, 1/4 W	110000-105
R116-119	Resistor, 50 Ω, 25%, 1/4 W	110000-100	R171	Resistor, 1 K Ω, 25%, 1/4 W	110000-100
R120	Resistor, 22 Ω, 25%, 1/4 W	110000-101	R172	Resistor, 270 Ω, 25%, 1/4 W	110000-274
R121-121	Resistor, 5 Ω	110000-101	R173	Resistor, 10 K Ω, 25%, 1/4 W	110000-105
R122			R174		

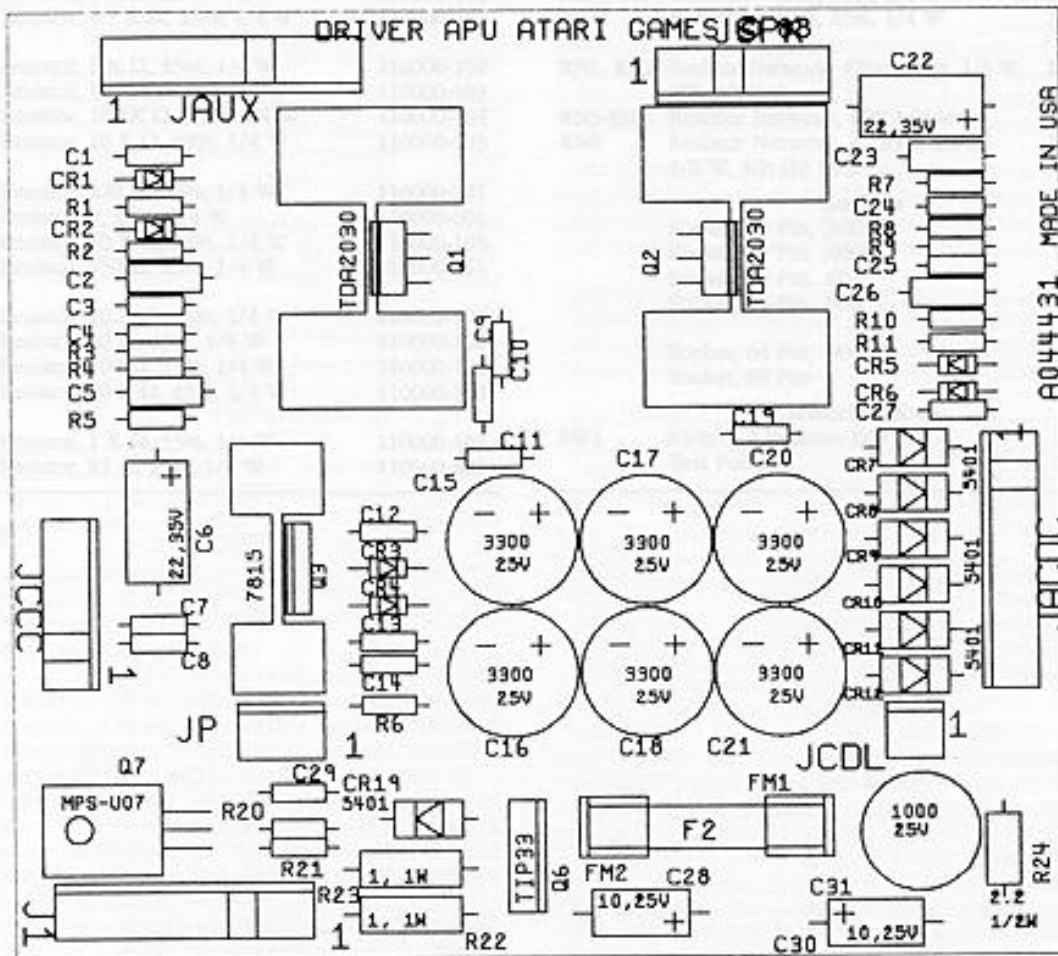

Figure 4-11 Race Drivin' Compact APU PCB Assembly
A044431-02 D

Race Drivin' Compact APU PCB Assembly Parts List

Designator	Description	Part No.	Designator	Description	Part No.
Capacitors			Transistors		
C1	Capacitor, .1 μ F, 50 V, Ceramic	122002-104	Q1, Q2	Integrated Circuit, TDA2030	137301-001
C2	Capacitor, .22 μ F, 50 V, Ceramic	122015-224	Q3	Integrated Circuit, 7815, Standup	137598-001
C3	Capacitor, .1 μ F, 50 V, Ceramic	122002-104	Resistors		
C4	Capacitor, .001 μ F, 50 V, Ceramic	122002-102	R1	Resistor, 10 K Ω , \pm 5%, 1/4 W	110000-103
C5	Capacitor, .22 μ F, 50 V, Ceramic	122015-224	R2	Resistor, 1, \pm 5%, 1/4 W	110000-010
C6	Capacitor, 22 μ F, 35 V, Electrolytic	124000-226	R3, R4	Resistor, 22 K Ω , \pm 5%, 1/4 W	110000-223
C7-C14	Capacitor, .1 μ F, 50 V, Ceramic	122002-104	R5	Resistor, 1 K Ω , \pm 5%, 1/4 W	110000-102
C15-C18	Capacitor, 3300 μ F, 25 V, Electrolytic, Radial	123003-338	R6	Resistor, 10, \pm 5%, 1/4 W	110000-100
C19	Capacitor, .1 μ F, 50 V, Ceramic	122002-104	R7	Resistor, 1 K Ω , \pm 5%, 1/4 W	110000-102
C20, C21	Capacitor, 3300 μ F, 25 V, Electrolytic, Radial	123003-338	R8, R9	Resistor, 22 K Ω , \pm 5%, 1/4 W	110000-223
C22	Capacitor, 22 μ F, 35 V, Electrolytic	124000-226	R10	Resistor, 1, \pm 5%, 1/4 W	110000-010
C23	Capacitor, .22 μ F, 50 V, Ceramic	122015-224	R11	Resistor, 10 K Ω , \pm 5%, 1/4 W	110000-103
C24	Capacitor, .1 μ F, 50 V, Ceramic	122002-104	Miscellaneous		
C25	Capacitor, .001 μ F, 50 V, Ceramic	122002-102	U1, U4	Connector, 2 Ckt, Header, .156 Ctr	179213-002
C26	Capacitor, .22 μ F, 50 V, Ceramic	122015-224	U2	Connector, 3 Ckt, Header, .156 Ctr	179213-003
C27	Capacitor, .1 μ F, 50 V, Ceramic	122002-104	U3	Connector, 6 Ckt, Header, .156 Ctr	179213-006
Diodes			U5	Connector, 9 Ckt, Header, .156 Ctr	179213-009
CR1-CR6	Diode, 1N4001	131048-001	HS1, HS2	Heatsink, TDA2030	178190-032
CR7-CR12	Diode, 1N5401	131051-002	HS3	Heatsink, 7815	178190-124

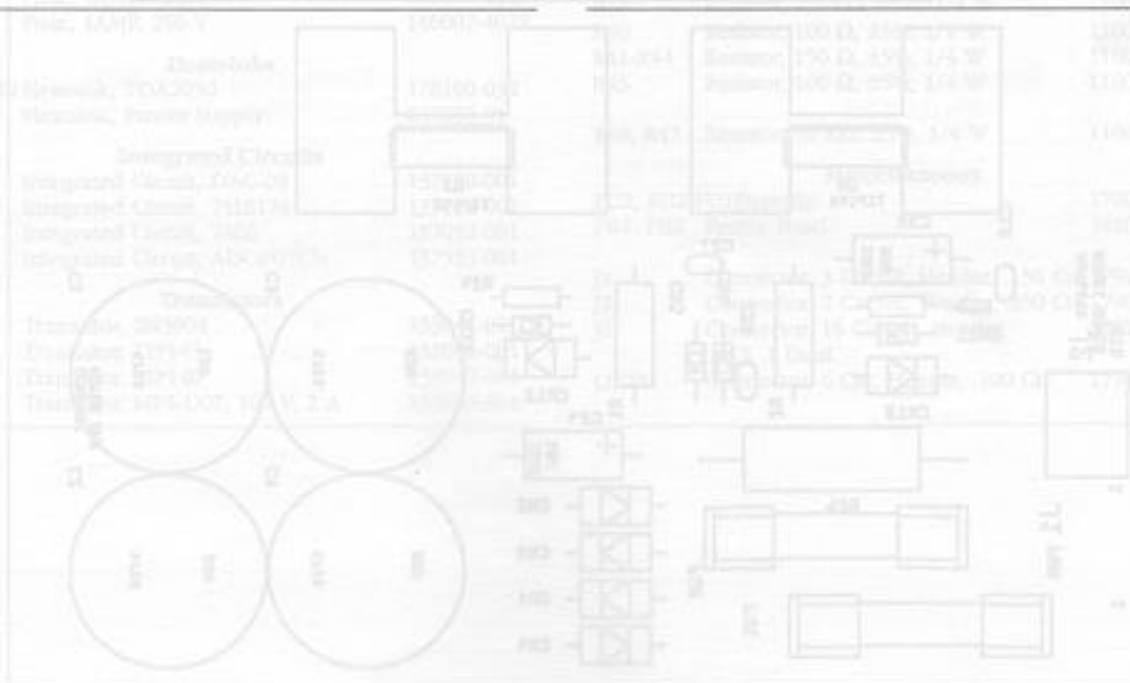

Figure 4-13 Race Drivin' Compact Motor Amplifier PCB Assembly
A00001-01 A

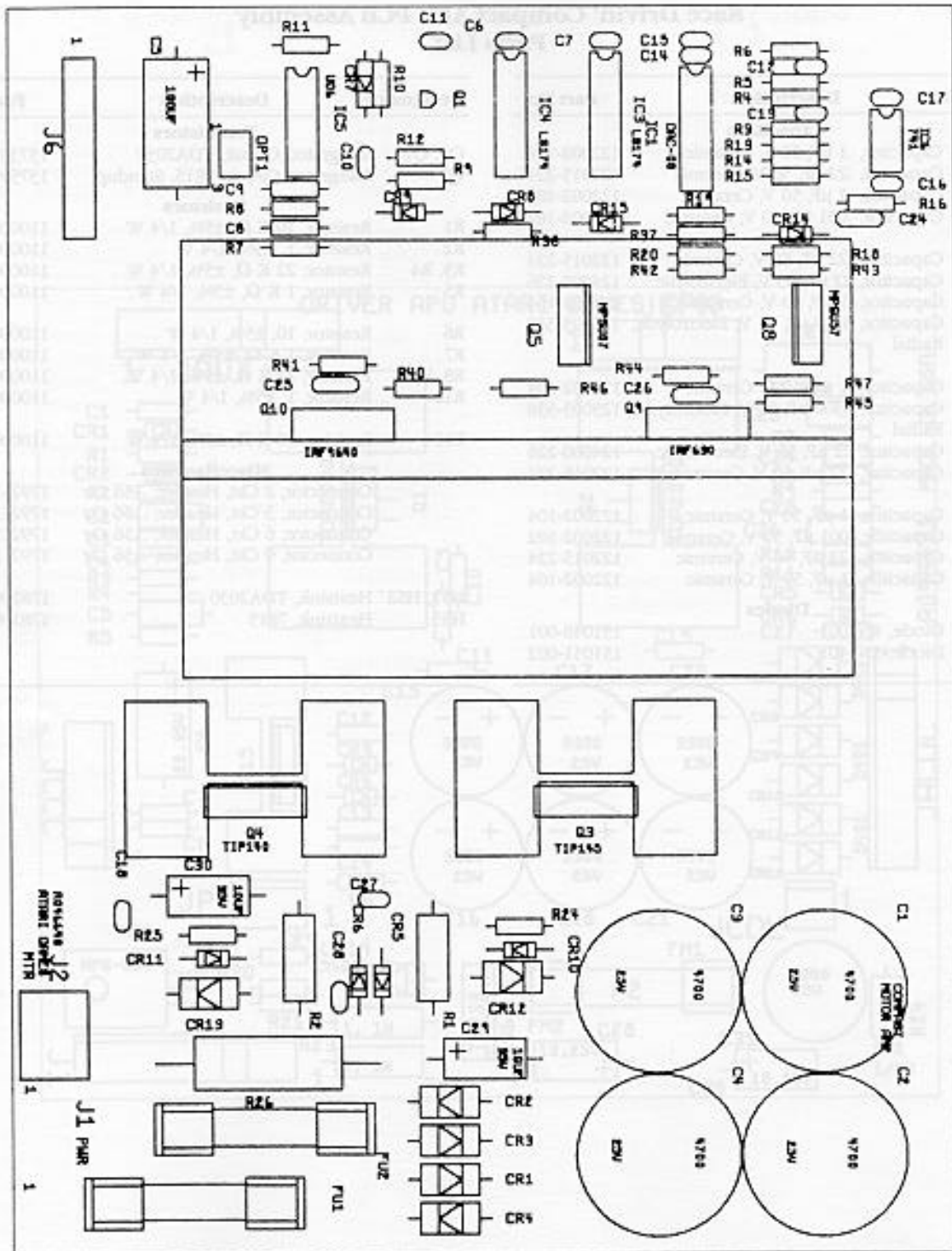
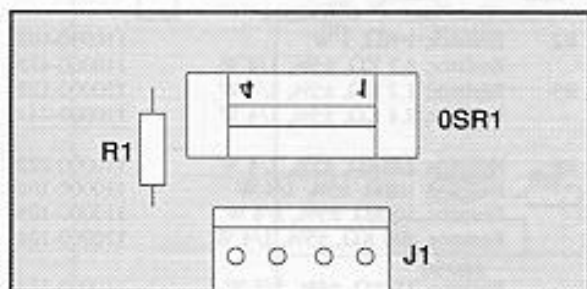

Figure 4-12 Race Drivin' Compact Motor Amplifier PCB Assembly
A046640-01 A

Race Drivin' Compact Motor Amplifier PCB Assembly Parts List

Designator	Description	Part No.	Designator	Description	Part No.
Capacitors					
C1-C4	Capacitor, 4700 μ F, 25 V, Electrolytic, Radial	123021-478	Q8	Transistor, MPSU57	133008-002
C5	Capacitor, 100 μ F, 16 V, Electrolytic	124008-107	Q9	Transistor, IRF630	133039-001
C6, C7	Capacitor, .1 μ F, 50 V, Ceramic	122002-104	Q10	Transistor, IRF9640	133037-001
C8, C9	Capacitor, 1000 pF, 100 V, Ceramic	122016-102	Resistors		
C10	Capacitor, .1 μ F, 50 V, Ceramic	122002-104	R1, R2	Resistor, 1 K Ω , 1 W	110030-102
C11	Capacitor, .22 μ F, 50 V, Ceramic	122022-224	R3	Resistor, 4.7 K Ω , \pm 5%, 1/4 W	110000-472
C12-C18	Capacitor, .1 μ F, 50 V, Ceramic	122002-104	R4, R5	Resistor, 1.2 K Ω , \pm 5%, 1/4 W	110000-122
C24-C26	Capacitor, .01 μ F, 50 V, Ceramic	122002-103	R6	Resistor, 2.4 K Ω , \pm 5%, 1/4 W	110000-242
C27, C28	Capacitor, .1 μ F, 50 V, Ceramic	122002-104	R7, R8	Resistor, 2.2 K Ω , \pm 5%, 1/4 W	110000-222
C29, C30	Capacitor, 10 μ F, 35 V, Electrolytic	124000-106	R9	Resistor, 1 K Ω , \pm 5%, 1/4 W	110000-102
Diodes					
CR1-CR4	Diode, 1N5401	131051-002	R10	Resistor, 10 K Ω , \pm 5%, 1/4 W	110000-103
CR5, CR6	Diode, 1N5352B, \pm 5%, Zener	131049-220	R11	Resistor, 100 K Ω , \pm 5%, 1/4 W	110000-104
CR7	Diode, 1N4148	131033-001	R12	Resistor, 15 K Ω , \pm 5%, 1/4 W	110000-153
CR8, CR9	Diode, 1N4747, Zener	131009-220	R13, R14	Resistor, 10 Ω , \pm 5%, 1/4 W	110000-100
CR10, CR11	Diode, 1N5362, \pm 5%, Zener	131049-230	R15	Resistor, 100 Ω , \pm 5%, 1/4 W	110000-101
CR12, CR13	Diode, 1N5401	131051-002	R16	Resistor, 10 K Ω , \pm 5%, 1/4 W	110000-103
CR14, CR15	Diode, 1N914	131052-001	R18-R20	Resistor, 2.2 K Ω , \pm 5%, 1/4 W	110000-222
Fuses					
FU1	Fuse, 4AMP, 250 V	146007-4022	R24, R25	Resistor, 100 Ω , \pm 5%, 1/4 W	110000-101
FU2	Fuse, 4AMP, 250 V	146007-4022	R26	Resistor, 0.5 Ω , 5 W, Wirewound	116029-5000
Heatsinks					
HTS1, HTS2	Heatsink, TDA2030	178190-032	R37	Resistor, 5.6 K Ω , \pm 5%, 1/4 W	110000-562
HTS3	Heatsink, Power Supply	047084-01	R38	Resistor, 2.2 K Ω , \pm 5%, 1/4 W	110000-222
Integrated Circuits					
IC1	Integrated Circuit, DAC-08	137159-001	R40	Resistor, 100 Ω , \pm 5%, 1/4 W	110000-101
IC3, IC4	Integrated Circuit, 74LS174	137122-001	R41-R44	Resistor, 150 Ω , \pm 5%, 1/4 W	110000-151
IC5	Integrated Circuit, 7406	137052-001	R45	Resistor, 100 Ω , \pm 5%, 1/4 W	110000-101
IC6	Integrated Circuit, ADOP07CN	137523-001	R46, R47	Resistor, 10 K Ω , \pm 5%, 1/4 W	110000-103
Transistors					
Q1	Transistor, 2N3904	133041-001	Miscellaneous		
Q3	Transistor, TIP145	133046-001	FU2, FU2-FU1	Fuseclip	179050-002
Q4	Transistor, TIP140	133047-001	FB1, FB2	Ferrite Bead	141003-001
Q5	Transistor, MPS-U07, 100 V, 2 A	133003-001	J1	Connector, 3 Circuit, Header, .156 Ctr	179213-003
			J2	Connector, 2 Circuit, Header, .250 Ctr	179069-002
			J6	Connector, 16 Circuit, Header, .1 X .1 Dual	179261-016
			OPT1	Connector, 6 Ckt, Header, .100 Ctr	179177-006



**Figure 4-13 Encoder Disk PCB Assembly
A046689-01 A**

**Encoder Disk PCB
Parts List**

Designator	Description	Part No.
R1	150Ω, 1/4 W, 5% Resistor	110000-151
OSR1	NPN Out, Dual Slotted Opto-Sensor	138000-001
J1	4-Ckt., .156 Ctr., Locking Connector	79-58356

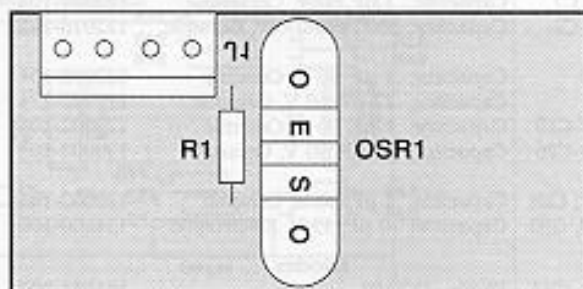

**Figure 4-14 Centering Disk PCB Assembly
A046691-01 B**

**Centering Disk PCB
Parts List**

Designator	Description	Part No.
R1	220Ω, 1/4 W, 5% Resistor	110000-221
OSR1	NPN Out, Single Slotted Opto-Sensor	138000-001
J1	4-Ckt., .156 Ctr., Locking Connector	79-58356



Race Drivin'™ Statistics Sheet

Location: _____ Date Recorded: _____

Meter: _____

STATISTICS INFORMATION

	Original	Autocross	Super Stunt	Original	Autocross	Super Stunt
Left Coins: _____	Laps by Track: _____			Free Games by Track: _____		
Right Coins: _____	_____	_____	_____	_____	_____	_____
Aux Coins: _____	No X Games by Track: _____			Total Games by Track: _____		
Idle Min: _____	_____	_____	_____	_____	_____	_____
Active Min: _____	1 X Play Games by Track: _____			Total Time by Track: _____		
Auto Games: _____	_____	_____	_____	_____	_____	_____
Error Count: _____	2 X Play Games by Track: _____			Avg Time by Track (sec): _____		
Total Games: _____	3+ X Play Games by Track: _____			Games by Car: _____		
_____	Champ Laps by Track: _____			_____	_____	_____
_____	2 Player Games by Track: _____			Inst Rpls: _____	_____	_____
_____	2 Player Time by Track: _____			Rpl Abrts: _____	_____	_____
_____	_____	_____	_____	Rpl Secs: _____	_____	_____
_____	_____	_____	_____	Total Credits: _____	_____	_____
_____	_____	_____	_____	Avg Time/Credit: _____	_____	_____

HISTOGRAM INFORMATION

Time	No. of Games	Time	No. of Games	Time	No. of Games	Time	No. of Games
0-99	_____	180-199	_____	280-299	_____	380-399	_____
100-119	_____	200-219	_____	300-319	_____	400-419	_____
120-139	_____	220-239	_____	320-339	_____	420-439	_____
140-159	_____	240-259	_____	340-359	_____	440-459	_____
160-179	_____	260-279	_____	360-379	_____	460 & UP	_____

ERROR COUNTS

Watch Dog Resets	_____	Bad Poly Buff Error	_____
Bus Error	_____	MSP Timeout Error	_____
Address Error	_____	ADSP Timeout Error	_____
Illegal Inst Error	_____	GSP Timeout Error	_____
Divide by Zero Err	_____	Generic Error	_____
Chk Inst Error	_____	NMI Error	_____
Trap Error	_____	Spur Exptn Error	_____
Piv Vio Error	_____	ASIC 65 Timeout Error	_____
GSP Handshake Error	_____	Illegal Error Code	_____

Warranty

Seller warrants that its printed-circuit boards and parts thereon are free from defects in material and workmanship under normal use and service for a period of ninety (90) days from date of shipment. Seller warrants that its video displays and laser-video disc players (in games supplied with displays and video-disc players) are free from defects in material and workmanship under normal use and service for a period of thirty (30) days from date of shipment. None of the Seller's other products or parts thereof are warranted.

If the products described in this manual fail to conform to this warranty, Seller's sole liability shall be, at its option, to repair, replace, or credit Buyer's account for such products which are returned to Seller during said warranty period, provided:

- (a) Seller is promptly notified in writing upon discovery by Buyer that said products are defective;
- (b) Such products are returned prepaid to Seller's plant; and
- (c) Seller's examination of said products discloses to Seller's satisfaction that such alleged defects existed and were not caused by accident, misuse, neglect, alteration, improper repair, installation, or improper testing.

In no event shall Seller be liable for loss of profits, loss of use, incidental or consequential damages.

Except for any express warranty set forth in a written contract between Seller and Buyer which contract supersedes the terms herein, this warranty is expressed in lieu of all other warranties expressed or implied, including the implied warranties of merchantability and fitness for a particular purpose, and of all other obligations or liabilities on the Seller's part, and it neither assumes nor authorizes any other person to assume for the Seller any other liabilities in connection with the sale of products by Seller.

The use of any non-Atari parts may void your warranty, according to the terms of the warranty. The use of any non-Atari parts may also adversely affect the safety of your game and cause injury to you and others. Be very cautious in using non-Atari-supplied components with our games, in order to ensure your safety.

Atari distributors are independent, being privately owned and operated. In their judgment they may sell parts or accessories other than Atari parts or accessories. Atari Games Corporation cannot be responsible for the quality, suitability or safety of any non-Atari part or any modification including labor which is performed by such distributor.



Atari Games Corporation

675 Sycamore Drive

P.O. Box 361110

Milpitas, CA 95036

