

**SEGA®**

# **POWER DRIFT**

UPRIGHT YZ TYPE (W/O MOTOR)

**OWNER'S MANUAL**

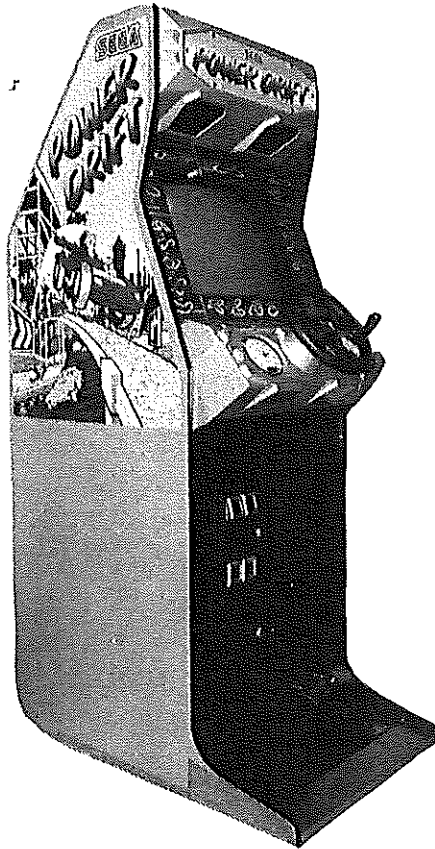

**SEGA ENTERPRISES, LTD.**

P/N# 420 5891

## TABLE OF CONTENTS

Introduction to the Owner's Manual .....	1
1. Handling Precautions .....	2
2. Prevention of Counterfeiting and Conversion .....	2
3. Precautions Concerning the Place of Installation .....	3
4. Name of Parts .....	3
5. Servicing the Handle Unit .....	4
6. Disassembling and Adjusting the Handle Unit .....	5
7. Disassembling and Adjusting the Accelerator and Brake .....	8
8. Adjusting the Accelerator/Brake Potentiometer .....	9
9. Adjustment of the Service Switch .....	10
10. DIP Switch Setting .....	11
11. EPROM/ROM Locations .....	12
12. Test Mode .....	13
13. Parts List .....	19
14. Schematic Diagram .....	24

### SPECIFICATIONS

INSTALLATION SPACE	: 700 mm (27.6 in.) W × 550 mm (21.6 in) D
HEIGHT	: 1650 mm (65.0 in.)
POWER	: 145 W
C.R.T.	: 19" MONITOR
WEIGHT	: 95 kg (209.4 lbs.)

### NOTE

- Descriptions herein contained may be subject to improvement changes without notice.

## INTRODUCTION TO THE OWNER'S MANUAL

SEGA ENTERPRISES, LTD., supported by its high electronic technology of LSIs, microprocessors, etc. and a wealth of experience, has for more than 30 years been supplying various innovative and popular game machines to the world market. This OWNER'S manual is intended to provide detailed comments together with all the necessary information covering the operation in general of electronic assemblies, electromechanicals, servicing control, spare parts, etc. as regards the POWER DRIFT, a new SEGA product. The manual is intended for those who have knowledge of electricity and technical expertise especially in ICs, CRTs, microprocessors, etc. Carefully read so as to acquire sufficient knowledge before working on the machine. Should there be a malfunction, non-technical personnel should under no circumstances touch the interior system.

## 1. HANDLING PRECAUTIONS

When installing or inspecting, be very careful of the following points and pay attention to ensure that the player can enjoy the game safely.

- Be sure to turn the power off before working on the machine.
- To insert or pull out the plug quickly is dangerous.
- It is necessary to make sure that the power cord or the grounding wire is not exposed on the road, etc. in a manner so as to be dangerous. Make sure that grounding connections are made safely at the position where so specified.
- Do not use any fuse that does not meet the specified rating.
- Make complete connections for the IC board and other connectors. Insufficient insertion is very dangerous.

Also, for the IC board circuit inspections, only the logic tone is allowed. The use of a tester is not permitted, so be careful in this regard. After confirming that there are no irregularities, turn the power ON.

## 2. PREVENTION OF COUNTERFEITING AND CONVERSION LABELLING

To prevent counterfeits and conversions, the following labels are put on all the SEGA products. When handling such goods, be sure to confirm the labels. They are used to prevent illegal acts such as the unauthorized copying of the products and the printed circuit boards thereof or carrying on business by manufacturing similar merchandise or by converting, selling or using such products or printed circuit boards.

### LICENSE SEAL

The following seal is put on the machines manufactured by SEGA.

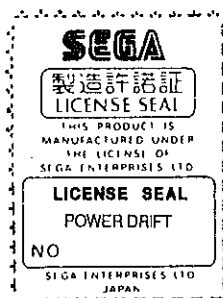

### ORIGINAL SEAL

The following seal is put on the kits, such as the printed circuit boards of SEGA products.



### COPYRIGHT NOTICE

This SEGA product has the copyright notice as follows:

© SEGA 1988

This signifies that this work was disclosed in 1988 and is the property of SEGA ENTERPRISES, LTD.

### 3. PRECAUTIONS CONCERNING THE PLACE OF INSTALLATION

The POWER DRIFT is an indoor game machine. Absolutely do not install it outside. Even indoors, avoid installing in places mentioned below so as to ensure proper usage:

- Places subject to rain or water leakage, or condensation due to humidity.
- In the proximity of an indoor swimming pool and/or shower.
- Places subject to direct sunlight.
- Places subject to heat sources from heating units, etc., or hot air.
- Vicinity of highly inflammable/volatile chemicals or hazardous matter.
- Sloped surfaces.
- Vicinity of anti-disaster facilities such as fire exits and fire extinguishers.
- Places subject to any type of violent impact.
- Dusty places.

### 4. NAME OF PARTS

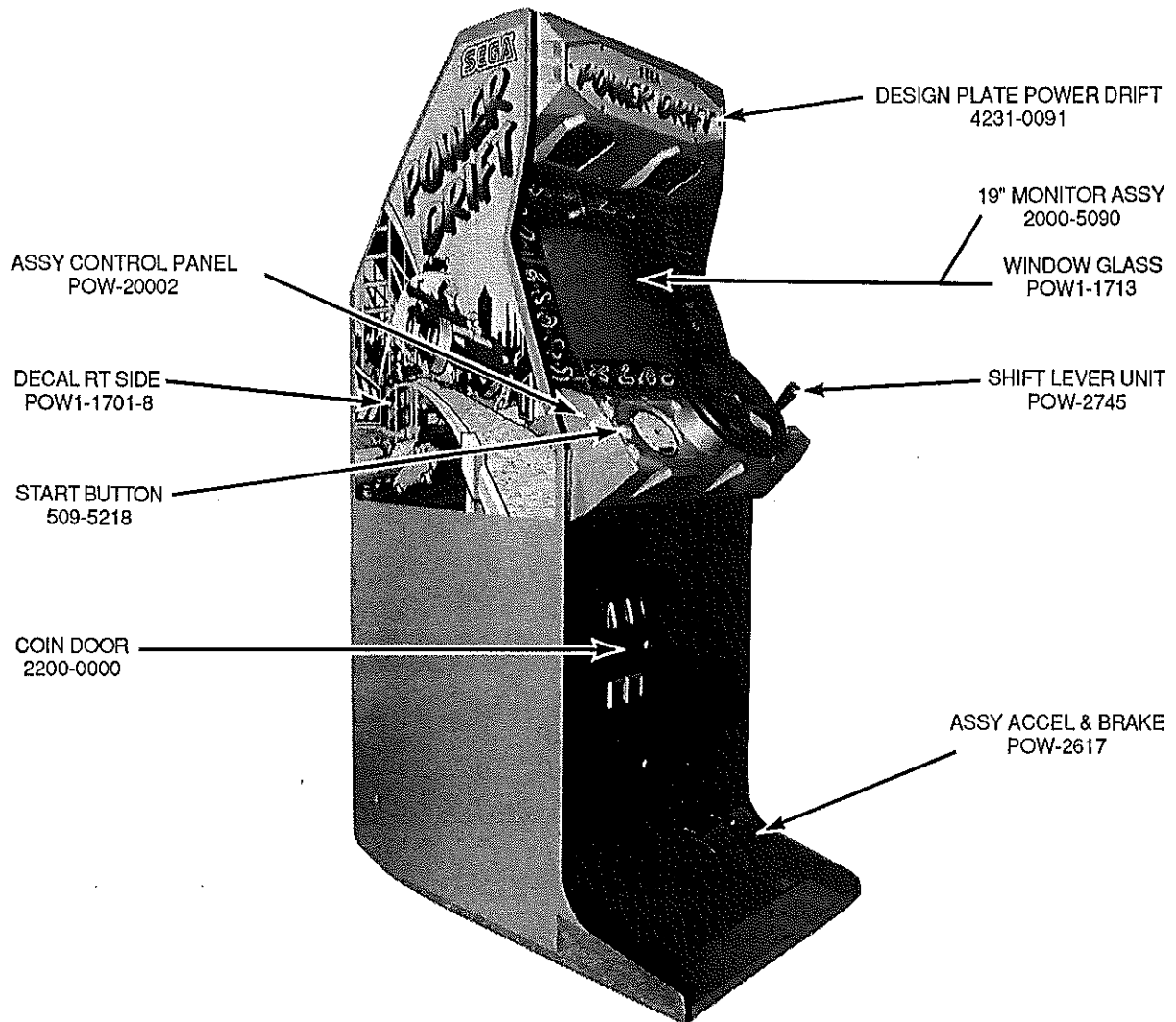

## TOOLS

(TAMPERPROOF WRENCH)

M4 540-0006-01  
M5 540-0007-01  
M6 540-0015-01  
M8 540-0009-01

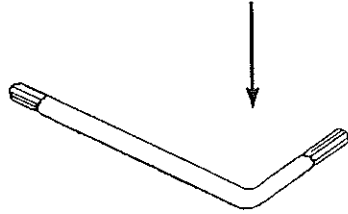

(TAMPERPROOF DRIVER)

M4 540-0018  
M5 540-0017

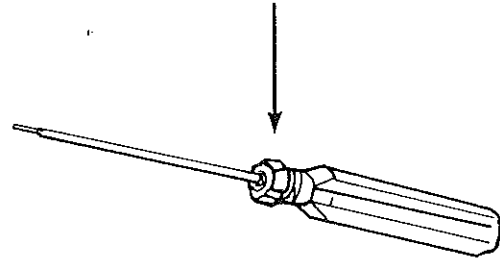

## 5. SERVICING THE HANDLE UNIT AND WINDOW MASK



- ① The HANDLE UNIT can be opened towards you by removing the 4 M8 x 40 TAMPERPROOF SCREWS.
- ② To remove the WINDOW GLASS from the cabinet, take off the TAMPERPROOF screws (M5) inside the WINDOW GLASS. K.
- ③ Next open it towards you.

This allows for the clearing of the monitor screen (CRT surfaces).

## 6. DISASSEMBLING AND ADJUSTING THE HANDLE UNIT

To open the dashboard, take off the 4 M8 TAMPERPROOF screws.  
After doing this, spring replacements and steering adjustments can be made.

POW-20002 Control Panel Assy

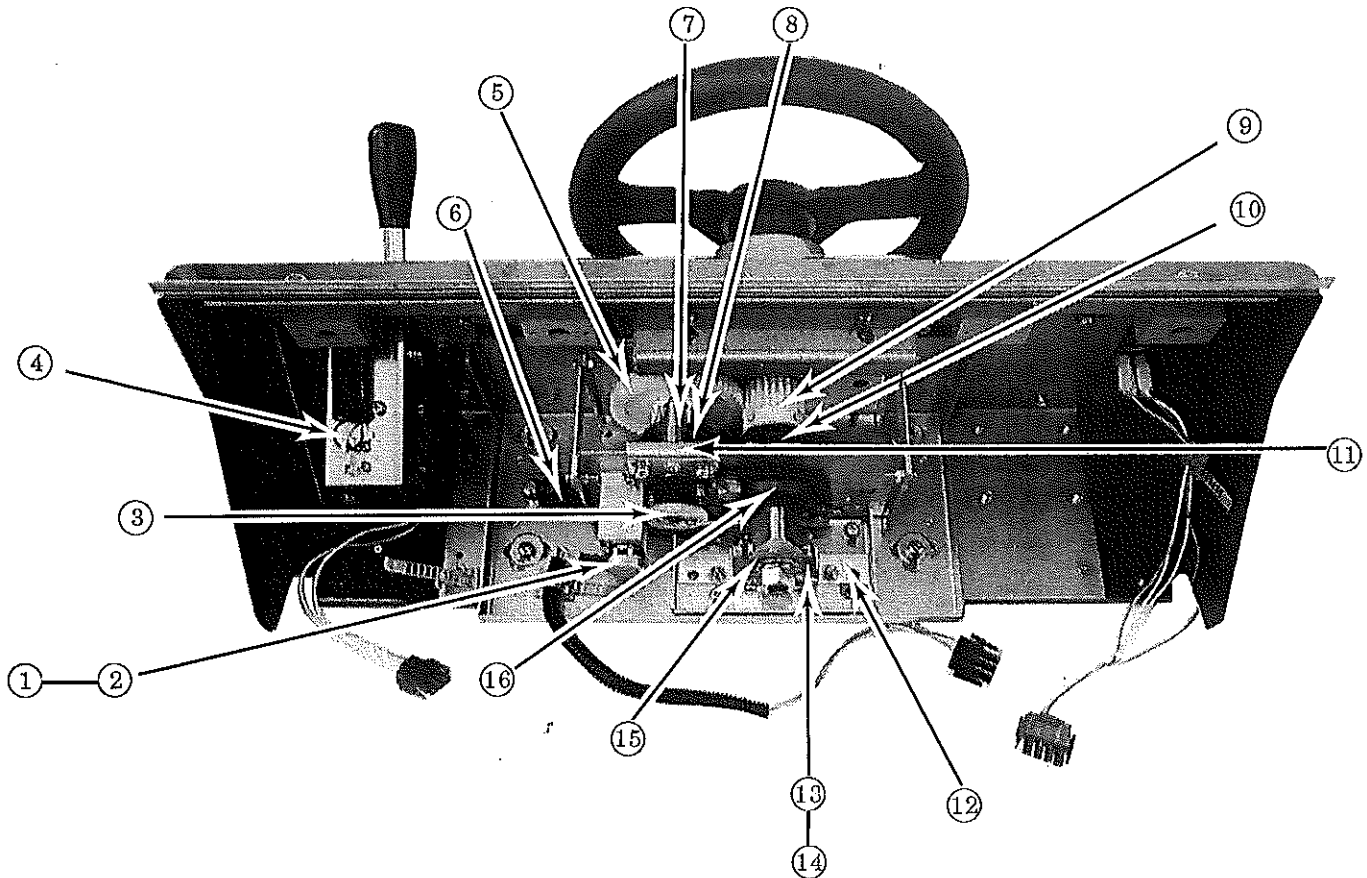

- |   |          |   |
|---|----------|---|
| ① | 220-5130 | 5K Potentiometer                        |
| ② | KR-1129  | Gear D (Pot. Gear)                      |
| ③ | 601-6172 | Gear 48                                 |
| ④ | POW-2745 | Shift Lever Assy (see Shift lever Assy) |
| ⑤ | KR-1126  | Gear A                                  |
| ⑥ | POW-2729 | Exit Spring                             |
| ⑦ | KR-1127  | Gear B                                  |
| ⑧ | POW-2708 | Arm Plate                               |
| ⑨ | KR-1127  | Gear B                                  |
| ⑩ | POW-2704 | Steering Shaft                          |
| ⑪ | KR-1115  | Stopper                                 |
| ⑫ | POW-2706 | Bumper Bracket                          |
| ⑬ | POW-2707 | Bumper Stopper                          |
| ⑭ | KR-1114  | Bumper                                  |
| ⑮ | POW-2734 | Braked Cam                              |
| ⑯ | 100-5035 | Bearing (Steering Shaft)                |
| ⑰ | KR-1109Y | Arm Bar                                 |

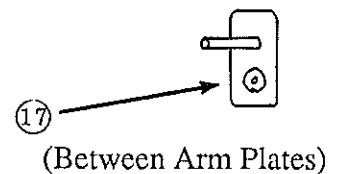

- ① Release the 2 adjusting screws of the potentiometer bracket and perform the necessary adjustments by changing its gear position, making sure that the variable is within the allowable extent as shown below, and then retighten the adjusting screw.

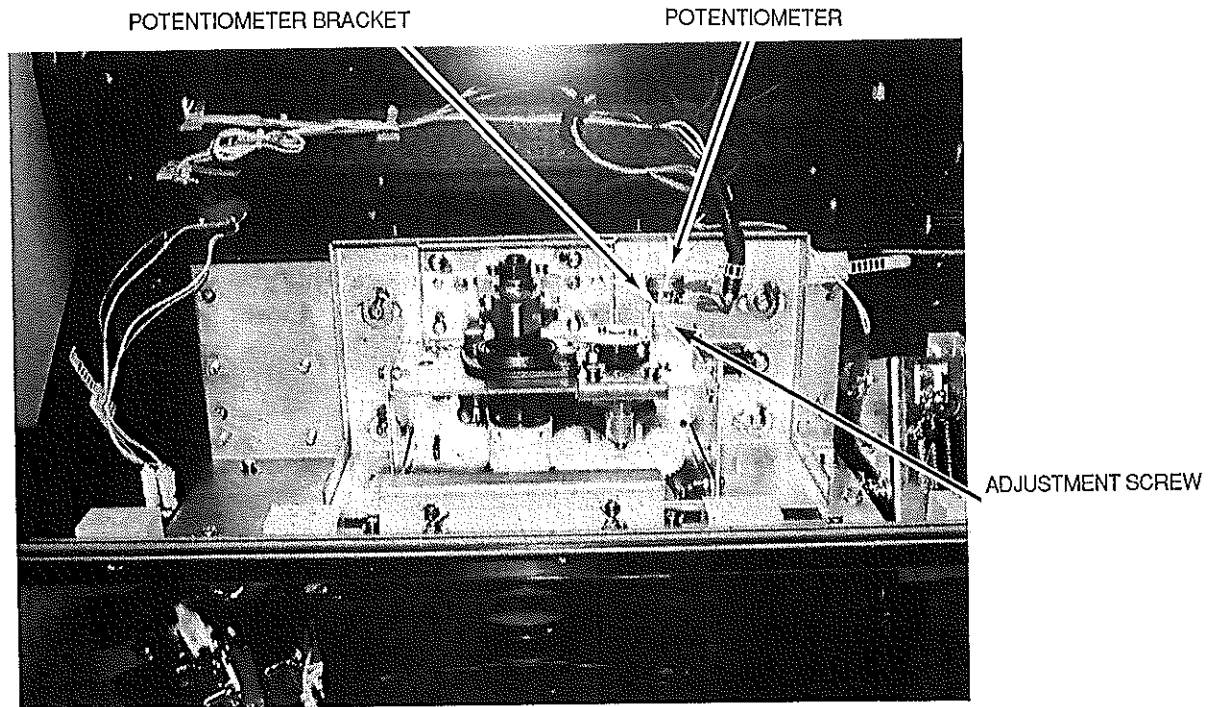

Standard value

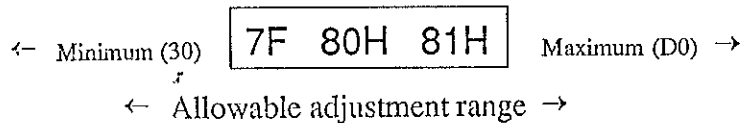

Assembly Shift Lever Unit YZ Type POW 2745

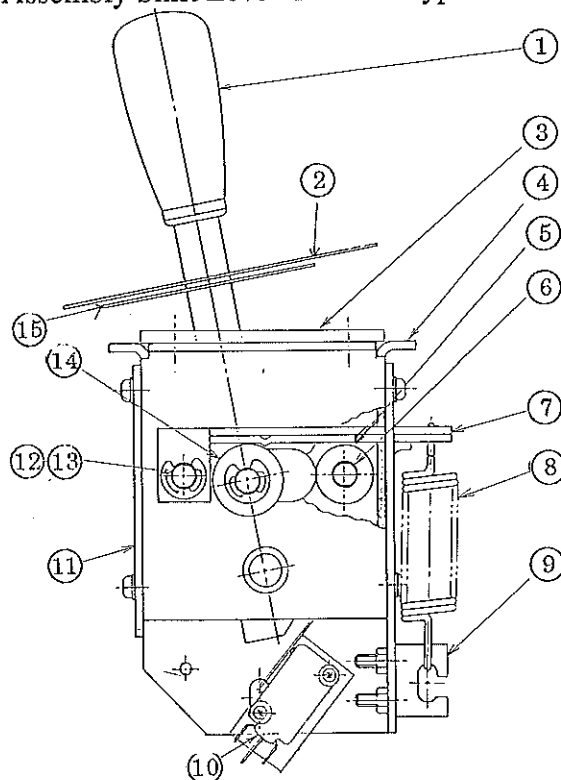

- ① POW-2740 Sub Assy Shift Lever
- ② POW-2732 Cover "B"
- ③ POW-2730 Guide Plate
- ④ POW-2202 Transmission Case "B"
- ⑤ POW-2206 Stopper Rubber
- ⑥ POW-2204 Stopper Shaft "A"
- ⑦ POW-2207 Cam
- ⑧ POW-2210 Extension Spring
- ⑨ POW-2208 Hook
- ⑩ 509-5088 Micro Switch
- ⑪ POW-2201X Transmission Case "A"
- ⑫ POW-2739 Stopper Shaft "B"
- ⑬ POW-2206 Stopper Rubber
- ⑭ 100-5018 Ball Bearing Ø8
- ⑮ POW-2731 Cover "A"

- 000-0316 2ea M3x16 Phillips Screw
- 000-0510-5 4ea M5x10 Phillips Screw
- 000-0416-5 2ea M4x16 Phillips Screw
- 065-0007 6ea 7mm E-Ring
- 061-0006 1ea M6 Spring Washer
- 060-0008 5ea M8 Flat Washer
- 054-0006 2ea M6 "U" Nut

Control Panel Assy Hardware List (POW-20002)

PART No.	Q/U	DESCRIPTION
000-0408-FS	2	M SCR PH W/FS M4 x 8
000-0416-FS	4	M SCR PH W/FS M4 x 16
000-0508	4	M SCR PH W/FS M5 x 8
000-0510	15	M SCR PH W/FS M5 x 10
000-0516	3	M SCR PH W/S M5 x 16
001-0516	15	M SCR FH M5 x 16
001-0520	2	M SCR FH M5 x 20
029-0152	3	TMP PRF SCR TH CROME M5 x 12
008-0415	4	TMP PRF SCR TH M4 x 16
008-0425	1	TMP PRF SCR TH M4 x 25
028-0007	3	SET SCR HEX SKT CP UNBR M4 x 10
028-0010	2	SET SCR HEX SKT CP M5 x 8
028-0014	4	SET SCR HEX SKT CP UNBR M4 x 4
000-0312-FS	2	M SCR PH W/FS M3 x 12
030-0825	4	HEX BLT M8 x 25
030-0630	6	HEX BLT M6 x 30
045-0004	8	COT PIN 1.6 x 15
045-0005	2	COT PIN 2 x 15
050-0012	1	HEX NUT M12
054-0005	18	U NUT M5
054-0006	17	U NUT M6
080-0005	6	FLT WSHR M5
060-0006	7	FLT WSHR M6
060-0008	4	FLT WSHR M8
060-0010	1	FLT WSHR M10
069-0020	1	FLT WSHR M12
061-0006	16	SPR WSHR M6
061-0008	4	SPR WSHR M8
061-0012	1	SPR WSHR M12
069-0022	1	FLT WSHR 5.5 - 14 x 1
028-0012	1	SET SCR CH SPCL M5 x 12
029-0078	3	TMP PRF SCR BH M6 x 16
045-0014	1	SPR PIN UNBR 3 x 26
006-3113	2	W SCR FH 3.1 x 13
054-0004	4	U NUT M4
030-0620	2	HEX BLT M6 x 20
000-0525-FS	2	M SCR PH W/FS M5 x 25
061-0005	2	SPR WSHR M5
051-0004	2	FLG NUT M4
059-0014	4	WELL NUT M4
090-0012	4g	SCREW LOCK (Three Bond K01C - 2009 RED)
090-0013	6g	GREASE (SHYOWA SHELL SEKIYU RETINAX A)
005-3516-F	2	W SCR RH W/F 3.5 x 16
069-0084	1	E RING 19mm
008-0420	2	TMP PRF SCR TH M4 x 20
059-0002	2	FLT WSHR 5.5 - 19 x 1.2
000-0516-FS	4	M SCR PH W/FS M5 x 16
008-0516	4	TMP PRF SCR TH M5 x 16



## 7. DISASSEMBLING AND ADJUSTING THE ACCELERATOR AND BRAKE

To remove the accelerator/brake unit, take off the 7 M5 TAMPERPROOF SCREWS.

Assembly Accelerator & Brake (POW-2617)

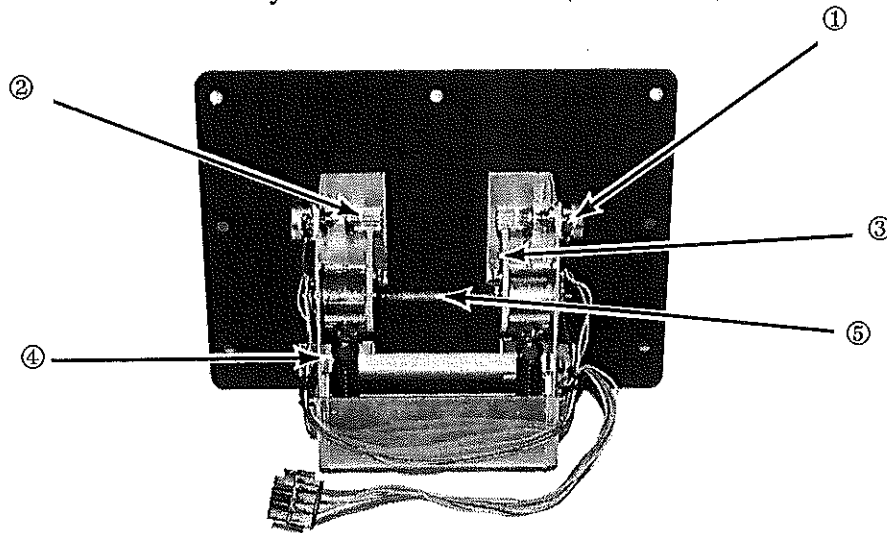

- ① 220-5130 5K potentiometer
- ② 601-5410 Gear 15 Ø 6 (Pot. Gear)
- ③ POW-2610 Adjust Gear
- ④ POW-2615 Extension Spring
- ⑤ POW-2611 Center Spring

000-0314-F	2ea	M3x14 Phillips Screw
000-0408-F5	10ea	M4x8 Phillips Screw
000-0510	4ea	M5x10 Phillips Screw
008-0510	5ea	M5x10 Tamperproof Screw
028-0002	4ea	M3x6 Set Screw (Phillips)
029-0200	4ea	M3x8 Tap Screw (Phillips)
030-0410	4ea	M4x10 Hex Bolt
045-0007	2ea	M3x30 Cotter Pin
054-0003	2ea	M3 "U" Nut
054-0005	9ea	M5 "U" Nut
060-0004	4ea	M4 Flat Washer
061-0004	4ea	M4 Spring Washer (Lock-Washer)
069-0020	2ea	M12 Flat Washer

## 8. ADJUSTING THE ACCELERATOR/BRAKE POTENTIOMETER

- ① DISPLAY THE SELF-TESTING MODE screen shown on page 15.
- ② Release the adjustment screws, move the bracket, and make adjustments so that the variable becomes 20H when the accelerator/brake is released and returns to its original position.
- ③ Even after the above procedure has been followed, if the variable is not within the allowable range, then slightly turn the gear to make an adjustment.

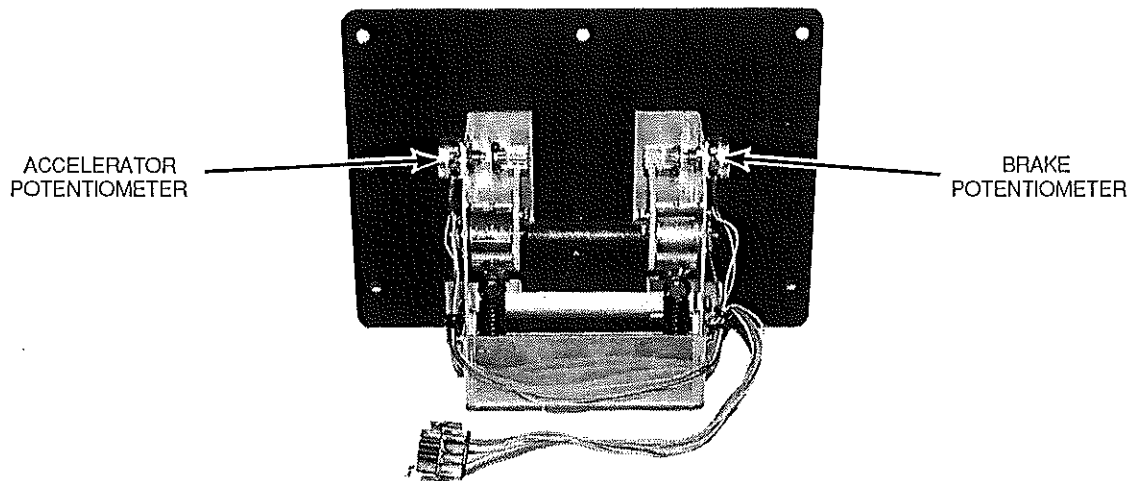

### ACCELERATOR

Minimum  
(20)

Standard  
↓

Maximum (fully open)  
(C0)

1CH 1DH 1EH 1FH 20H 21H 22H 23H 24H →

### BRAKE

(20)

→ Allowable adjustment range →

(C0)

## 9. ADJUSTMENT OF THE SERVICE SWITCH

The layout as shown below can be viewed by opening the coin chute door.

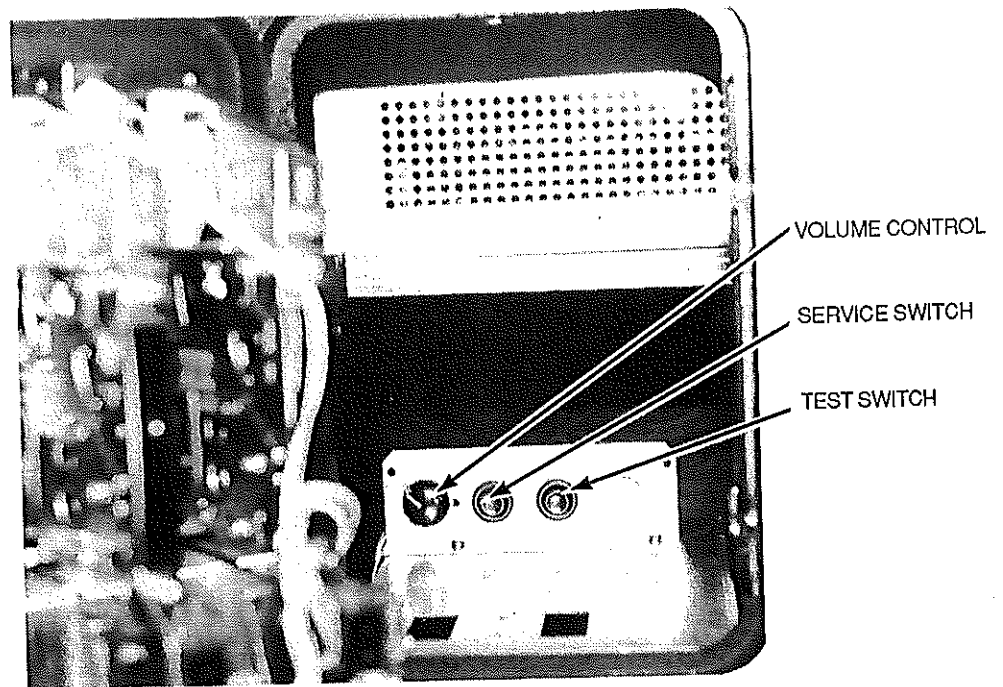

### OPERATING INSTRUCTIONS

- SERVICE SWITCH ..... Used for the purpose of servicing and increasing the credits without registering on the meter (this allows you to check the game).
- TEST SWITCH ..... For operating this switch, see SELF-TESTING.
- VOLUME CONTROL ..... Potentiometer Adjustment

# 10. DIP SWITCH SETTING

## COIN/CREDIT OPTION SWITCH SETTING

## DIP SWITCH A

OPTION		1	2	3	4	5	6	7	8
1 COIN	1 CREDIT	OFF	OFF	OFF	OFF	OFF	OFF	OFF	OFF
1 COIN	2 CREDITS	ON	OFF	OFF	OFF	ON	OFF	OFF	OFF
1 COIN	3 CREDITS	OFF	ON	OFF	OFF	OFF	ON	OFF	OFF
5 COINS	1 CREDIT	ON	ON	OFF	OFF	ON	ON	OFF	OFF
6 COINS	1 CREDIT	OFF	OFF	ON	OFF	OFF	OFF	ON	OFF
1 COINS	6 CREDIT	ON	OFF	ON	OFF	ON	OFF	ON	OFF
2 COINS	1 CREDIT	OFF	ON	ON	OFF	OFF	ON	ON	OFF
3 COINS	1 CREDIT	ON	ON	ON	OFF	ON	ON	ON	OFF
4 COINS	1 CREDIT	OFF	OFF	OFF	ON	OFF	OFF	OFF	ON
2 COINS	3 CREDITS	ON	OFF	OFF	ON	ON	OFF	OFF	ON
6 COINS	4 CREDITS	OFF	ON	OFF	ON	OFF	ON	OFF	ON
4 COINS	3 CREDITS	ON	ON	OFF	ON	ON	ON	OFF	ON
5 COINS	6 CREDITS	OFF	OFF	ON	ON	OFF	OFF	ON	ON
4 COINS	5 CREDITS	ON	OFF	ON	ON	ON	OFF	ON	ON
2 COINS	3 CREDITS	OFF	ON	ON	ON	OFF	ON	ON	ON
NO USE		ON	ON	ON	ON	ON	ON	ON	ON
		COIN SW. #1				COIN SW. #2			

POWER DRIFT PCB ASSY  
(834-6697-04)

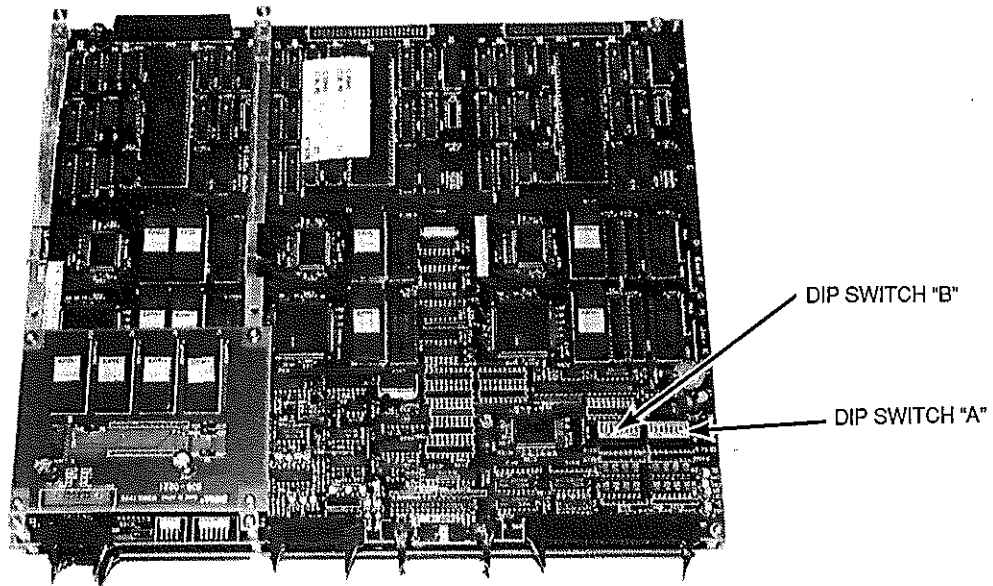

## GAME OPTION SWITCH SETTING

## DIP SWITCH B

GAME OPTION SETTING		1	2	3	4	5	6	7	8
* CABINET TYPE	MOVING UPRIGHT	OFF	OFF						
	MINI UPRIGHT	ON	OFF						
	NO USE	OFF	ON						
* ADVERTISE SOUND	OFF		OFF						
	ON			ON					
* EVER OFF					OFF				
* INITIAL CREDIT	2 CREDIT					OFF			
	1 CREDIT					ON			
* CONTINUE GAME	YES						OFF		
	NO						ON		
* GAME DIFFICULTY	NORMAL							OFF	OFF
	EASY							ON	ON
	HARD							OFF	ON
	HARDEST							ON	ON

\* When DIP Switch B. 5 is set to "ON", also set DIP SWITCH B. 6 to "ON".

# 11. EPROM/ROM LOCATIONS

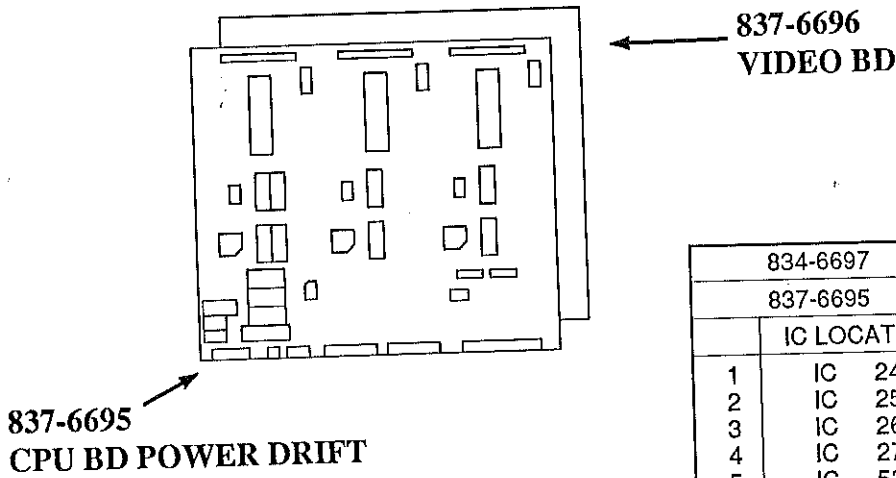

**CPU BD POWER DRIFT 837-6695**

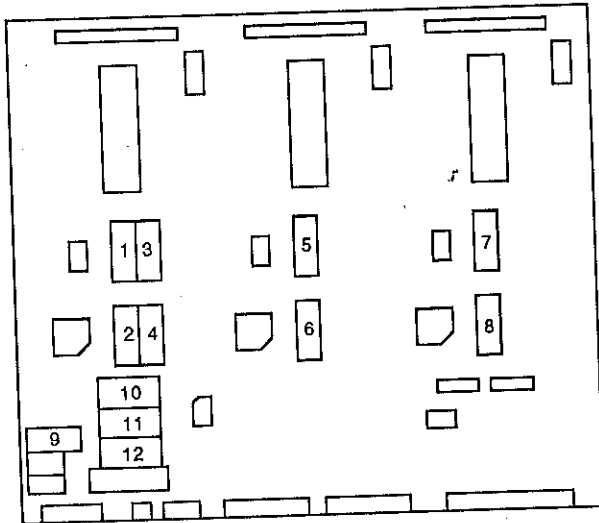

**VIDEO BD POWER DRIFT 837-6696**

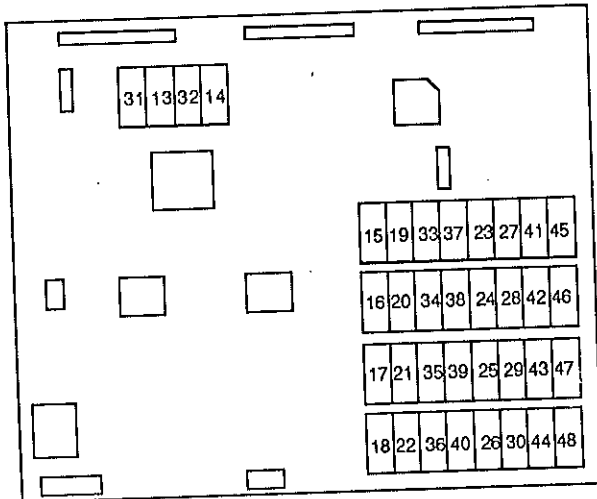

834-6697		GAME BD POWER DRIFT		
837-6695		CPU BD POWER DRIFT		
	IC LOCATION	NUMBER	MAIN WORK	
1	IC 24	EPR-11745	PROGRAM	
2	IC 25	EPR-11746		
3	IC 26	EPR-11747		
4	IC 27	EPR-11748		
5	IC 53	EPR-11749A		
6	IC 54	EPR-11750A		
7	IC 80	EPR-11751		
8	IC 81	EPR-11752		
9	IC 102	EPR-11753	SOUND PROGRAM	
10	IC 107	EPR-11892	(2M EPROM) SOUND DATA	
11	IC 106	EPR-11893		
12	IC 105	EPR-11894		
837-6696		VIDEO BD POWER DRIFT		
13	IC 16	EPR-11789	LINE OBJ	
14	IC 14	EPR-11791		
15	IC 67	EPR-11757	OBJECT	
16	IC 75	EPR-11758		
17	IC 86	EPR-11759		
18	IC 114	EPR-11760		
19	IC 66	EPR-11761		
20	IC 74	EPR-11762		
21	IC 85	EPR-11763		
22	IC 113	EPR-11764		
23	IC 63	EPR-11773		
24	IC 71	EPR-11774		
25	IC 82	EPR-11775		
26	IC 110	EPR-11776		
27	IC 62	EPR-11777		
28	IC 70	EPR-11778		
29	IC 81	EPR-11779		
30	IC 109	EPR-11780		
31	IC 17	EPR-11790	LINE OBJ	
32	IC 15	EPR-11792		
33	IC 65	EPR-11765	OBJECT	
34	IC 73	EPR-11766		
35	IC 84	EPR-11767		
36	IC 112	EPR-11768		
37	IC 64	EPR-11769		
38	IC 72	EPR-11770		
39	IC 83	EPR-11771		
40	IC 111	EPR-11772		
41	IC 61	EPR-11781		OBJECT
42	IC 69	EPR-11782		
43	IC 80	EPR-11783		
44	IC 108	EPR-11784		
45	IC 60	EPR-11785		
46	IC 68	EPR-11786		
47	IC 79	EPR-11787		
48	IC 107	EPR-11788		

## 12. TEST MODE

This test mode verifies that the game board is correctly operating or if there are any malfunctions. Color and sound adjustments can also be tested using the test mode.

### 1. SELECTION OF INDIVIDUAL TEST

(1) Push the TEST SW and the following test menu will be displayed:

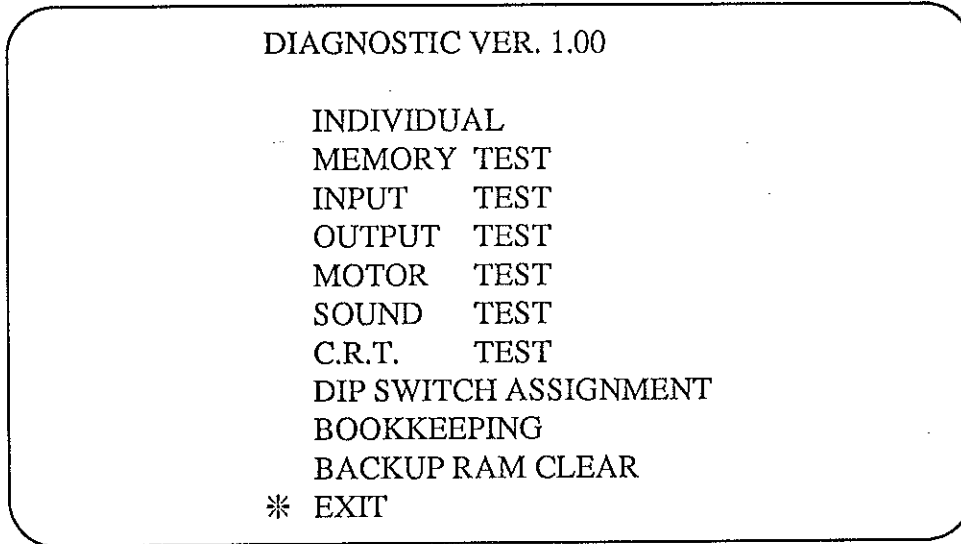

TEST ITEMS	DESCRIPTION
1. INDIVIDUAL .....	INDIVIDUAL/CONTINUE mode change.
2. MEMORY TEST .....	Tests the game board's memory IC's.
3. INPUT TEST .....	Checks the numerical value of each switch, steering handle, etc.
4. OUTPUT TEST .....	Checks the "ON" and "OFF" of the START SW LAMP and COIN SOLENOID.
5. MOTOR TEST .....	Tests in this mode are not applicable for the type.
6. SOUND TEST .....	Checks the SOUND ROM and POWER AMPLIFIER.
7. C.R.T. TEST .....	Checks the monitor adjustment color bar display.
8. DIP SWITCH ASSIGNMENT ...	Displays the DIP SW setting status.
9. BOOKKEEPING .....	Displays the records of the number of game plays, game time, etc.

- 10. BACKUP RAM CLEAR ..... Clears the records of the number of game plays, game time, etc.
- 11. EXIT ..... Returns to the ordinary game screen.
- (2) Turning the steering handle to the right/left will cause the \* mark to move upward/down. Move the desired test item and push the TEST SW to select the test.
- (3) When the tests are finished, move the \* mark to EXIT and push the TEST SW.

2. DESCRIPTION OF EACH TEST ITEM

(1) INDIVIDUAL

With the \* mark positioned at INDIVIDUAL, pushing the TEST SW or START BUTTON changes the mode from INDIVIDUAL to CONTINUE. Similarly, with the \* mark positioned at CONTINUE, pushing the TEST SW or START BUTTON changes the mode from CONTINUE to INDIVIDUAL.

In the CONTINUE MODE, when a test item is finished, the next test item automatically starts, thus making it convenient when performing all the tests continuously.

(2) MEMORY TEST

This test checks whether the memory IC's on the game board are correct or not.

The indication of "GOOD" means the IC No. is OK. If a memory IC is incorrect, the IC No. will be indicated as "BAD."

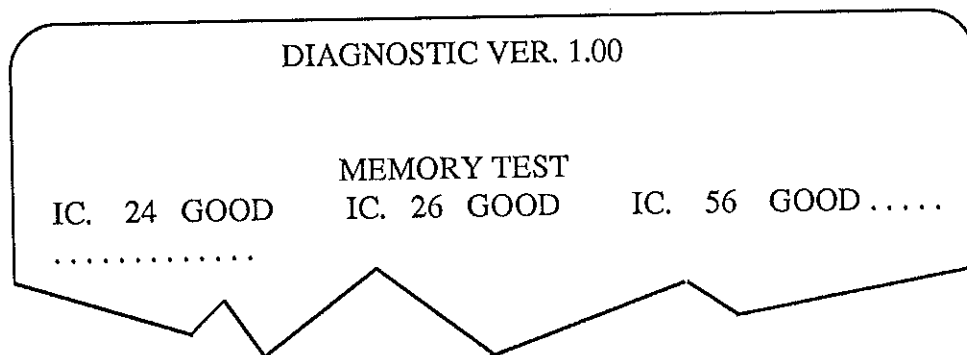

### (3) INPUT TEST

Checks the operation of each switch, and the V.R. numerical value of the steering handle, accelerator and brake.

DIAGNOSTIC VER. 1.00			
INPUT TEST			
COIN #1	OFF	START	OFF ①
COIN #2	OFF	SERVICE	OFF
LOW GEAR ②			
HANDLE	RIGHT	LEFT	80H ③
ACCEL			20H ④
BRAKE			20H

- ① Operate each switch. The "ON" indication means that the corresponding SW is OK.
- ② When the shift lever is in a low position, "LOW GEAR" will be indicated and similarly when in a high position, "HIGH GEAR."
- ③ The steering test is OK if the numerical value increases to D0H or higher when it is turned to the right and decreases to 30H or lower when it is turned to the left, and becomes  $80H \pm 1$  when taking your hand off the steering handle.
- ④ The accelerator/brake test is OK if the numerical value increases to C0H or higher when it is applied and becomes  $20H \pm 1$  when it is not applied.

### (4) OUTPUT TEST

Checks the operation of the START LAMP and the OPEN/CLOSE of the coin solenoid which is used to lock in a coin.

DIAGNOSTIC VER. 1.00	
OUTPUT TEST	
START LAMP	ON
COIN SOLENOID	OPEN

In accordance with the on-screen display, the ON/OFF of the START LAMP and the OPEN/CLOSE of the SOLENOID will take place in one second cycles, and if not, it is considered to be malfunctioning.

(5) N/A



## (6) SOUND TEST

Only the sound can be manually outputted. Check sound ROM, sound circuit and the operation of the power amplifier.

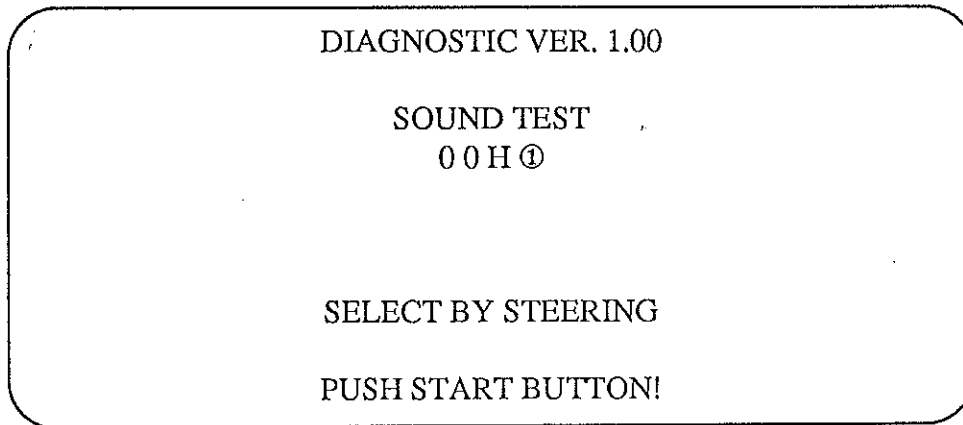

- ① Turning the steering handle to the right/left results in increasing/decreasing the numerical value of the sound No. Stop the steering handle at the desired number, push the START button, and that number's sound will be emitted. For the sound numbers and the description thereof, refer to the following table:

Sound No.	Description
00H - 3FH	Engine sound
61H - 8DH	Effects
90H - 97H	B.G.M.
99H - 9DH	FM effects
A0H - C3H	VOICE
FFH	ALL SOUNDS OFF

## (7) C.R.T. TEST

The monitor adjustment color bar is indicated.

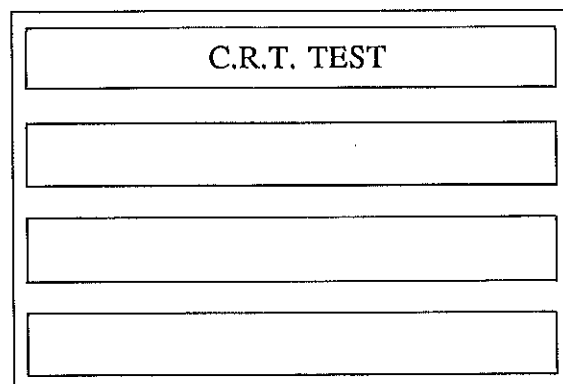

RED

GREEN

BLUE

① C.R.T. POSITION CHECK

Brightness  
(from white to black)

- ① Adjust the screen's position and size by performing the C.R.T. POSITION CHECK.

(8) DIP SWITCH ASSIGNMENT

Displays the present setting status of DIP SWITCH A & B. For the function of each switch, refer to 24. DIP SWITCHES.

DIAGNOSTIC VER. 1.00								
DIP SWITCH ASSIGNMENT								
	1	2	3	4	5	6	7	8
DIP SW A.	OFF	OFF	OFF	OFF	OFF	OFF	OFF	OFF
DIP SW B.	OFF	OFF	ON	OFF	OFF	OFF	OFF	OFF
A 1234	COIN SW #1			1 COIN	1 CREDIT			
A 5678	COIN SW #2			1 COIN	1 CREDIT			
B 12	CABINET TYPE			MOVING				
B 3	ADVERTISE SOUND			ON				
B 4	EVER OFF							
B 5	INITIAL CREDIT			2 CREDIT				
B 6	CONTINUE GAME			YES				
B 78	GAME DIFFICULTY			NORMAL				

(9) BOOKKEEPING

Displays the records of the number of game plays, game time, etc. Push the START button to proceed to the next screen.

```

DIAGNOSTIC VER. 1.00

BOOKKEEPING

COIN CHUTE #1    ** (1)
COIN CHUTE #2    ** (2)
COIN CREDITS     ** (3)
SERVICE CREDITS ** (4)
TOTAL CREDITS    *** (5)

TOTAL TIME ** H ** M ** S (6)

PUSH START BUTTON
    
```

```

DIAGNOSTIC VER. 1.00

NUMBER OF GAMES    *** (7)
CONTINUE           *** (8)

AVE. SCORE         ***** (9)
TOP SCORE          ***** (10)
LOW SCORE           ***** (11)

** GAME TIME **

TOTAL    ** H ** M * S (12)
AVERAGE ** H ** M * S (13)
LONGEST  ** H ** M * S (14)

PUSH START BUTTON
    
```

(10) BACKUP RAM CLEAR

```

DIAGNOSTIC VER. 1.00

BACK UP RAM CLEAR

*NO
YES

SELECT BY STEERING

PUSH TEST BUTTON
    
```

Description of Numbers

- ① Number of coins put in COIN CHUTE 1
- ② Number of coins put in COIN CHUTE 2
- ③ Total credits of COIN CHUTE 1 & 2
- ④ Service switch credits
- ⑤ Total credits of ③ and ④
- ⑥ Total time during which the power was "ON"
- ⑦ Number of game plays (including CONTINUE)
- ⑧ Number of CONTINUE plays out of ⑦ above
- ⑨ Average score
- ⑩ High score
- ⑪ Lowest score
- ⑫ Time during which game was played (out of ⑥ above)
- ⑬ Average game time
- ⑭ Longest game time

All the BOOKKEEPING contents can be closed. When doing so, bring the \* mark to yes and push the TEST button. When not clearing, bring the \* mark to NO and push the TEST button.

### 13. PARTS LIST

ITEM	PARTS NUMBER	DESCRIPTION	QTY
1	1050-0064	MAIN SWITCH BRACKET	1
2	1170-0184	TERM PLT. (4P)	1
3	1170-5131	TERM BLK (5P)	1
4	1170-5131A	TERMINAL	5
5	1300-5018	SPEAKER, 8-OHM 10W	2
6	1500-0265	CAP, 24000 UF	1
7	1500-0265A	CAP MOUNT	1
8	2000-5090	MONITOR, 19" RGB	1
9	2200-0000	COIN DOOR ASSY	1
10	2200-5179	VOL. CNTRL 5K	1
11	2600-0011-1	AXIAL FLOW FAN	1
12	2600-0011-2	FAN SCREEN GUARD	1
13	2800-0418	STRAIN RELIEF	1
14	3901-5120	FLUORESCENT LAMP (1V173)	1
15	3901-5120-01	FLUORESCENT FIXTURE (2V810)	1
16	4001-5089	POWER SUPPLY 5V @ 15A	1
17	4201-5891-03	OWNER'S MANUAL, POWER DRIFT	1
18	4211-6550	STICKER, SERVICE SWITCH	1
19	4211-6592	STICKER, ON/OFF	1
20	4211-6671	STICKER, DANGER	1
21	4211-6682	STICKER, SERVICE INSTRUCTIONS	1
22	4211-6690-01	STICKER, 120V	1
23	4211-7224	STICKER, FUSE 6A, 5A, 3A	1
24	4231-0091	MARQUEE PLEX POWER DRIFT	1
25	4810-0157A	DIODE BRIDGE, 8A	1
26	5090-0039	SWITCH, ON/OFF	1
27	5090-5028	SWITCH, MOMENTARY	2
28	5140-0031	FUSE, 6A	1
29	5140-0034	FUSE, 5A (SLO)	1
30	5140-0036	FUSE, 3A	1
31	5140-0045	FUSE HOLDER, 1P	1
32	5140-0064	FUSE HOLDER, 2P	1
33	5601-5095	POWER TRANSFORMER, 160P4	1
34	6000-0078	POWER CORD	1
35	6010-0001	FUSE COVER	3
36	6010-0042	KNOB, 1/4" SHAFT	1
37	6010-0420	LINE FILTER, 5A	1
38	MO0-1215Y	POWER CORD BOX	1
39	POW0-1703	HOLDER BRACKET A (CONTROL PNL)	1
40	POW1-1623	ASSY ACCEL PEDAL	1
41	POW1-1701-B	DECAL, RIGHT SIDE	1
42	POW1-1701-C	DECAL, LEFT SIDE	1
43	POW1-1702	SWITCH UNIT BRACKET	1
44	POW1-1706	HINGE 580	1
45	POW1-1707	SUPPORT BRACKET RIGHT	1

ITEM	PARTS NUMBER	DESCRIPTION	QTY
46	POW1-1708	SUPPORT BRACKET LEFT	1
47	POW1-1712	MONITOR BEZEL	1
48	POW1-1713	WINDOW GLASS	1
49	TB0-3003	T.V. MASK 20	1
50	YZ0-0016	SHIELD COVER U/R	1
51	YZ0-0019	SHIELD CASE U/R	1
52	YZ0-1031-A	BILLBOARD COVER	1
53	YZ0-1031-B	SPEAKER NET	2
54	YZ1-1604	SUPPORT BRACKET FRONT	1
55	YZ1-1699	HINGE SUPPORT BRACKET	1
56	008-0408	TMP PRF SCR M4X8	2
57	008-0416	TMP PRF SCR TH M4X16	8
58	008-0520	TMP PRF SCR TH M5X20	2
59	008-0525	TMP PRF SCR TH M5X25	7
60	008-0545	TMP PRF SCR M5X45	2
61	029-0038	TMP PRF SCR SCR BH BLK M6X20	8
62	029-0152	TMP PRF SCR TH CROME M5X12	3
63	029-0192	TMP PRF SCR TH CROME M5X20	3
64	029-0217	TMP PRF SCR BH CROME M8X40	4
65	069-0087	FLT WSHR CROME M8	4
66	220-5130	VOL CONT B-5K OHM	1
67	280-5079	NYLATCH GROMMET	16
68	280-5080	NYLATCH PLUNGER	16
69	421-6119-91	STICKER FCC	1
70	421-6120	STICKER SEGA USA	1
71	421-6709	STICKER SERVICE INSTR ENG	1
72	421-7329	ADJUST INSTR SHEET POWER DRIFT	1
73	600-5726-01	WIRE HARN EXT VCC	1
74	600-5726-02	WIRE HARN EXT PWR AMP	1
75	600-5726-04	WIRE HARN EXT RGB	1
76	600-5726-08	WIRE HARN SOUND	1
77	600-5726-09	WIRE HARN RGB	1
78	600-5726-13	WIRE HARN EXT CAB POW	1
79	600-5726-14	WIRE HARN EXT CONTROL	1
80	600-5726-15	WIRE HARN VCC POW	1
81	600-5726-16	WIRE HARN I/O POW	1
82	834-6697-04	GAME BD POWER DRIFT	1
83	839-0035-01	PWR AMP DC 12V 10W	1
84	839-0207	FILTER BD GALAXY FORCE U/R	1
85	POW-20002	ASS'Y CONT PANEL YZ TYPE	1
86	POW-2210	EXT SPRING	1
87	POW-2615	EXT SPRING	2
88	POW-2617	ASS'Y ACCEL & BRAKE YZ TYPE	1
89	POW-2729	EXT SPRING	2
90	SGB-1035X	KEY BAG	1
91	YZ-1031	ASSY, BILL BOARD COVER	1

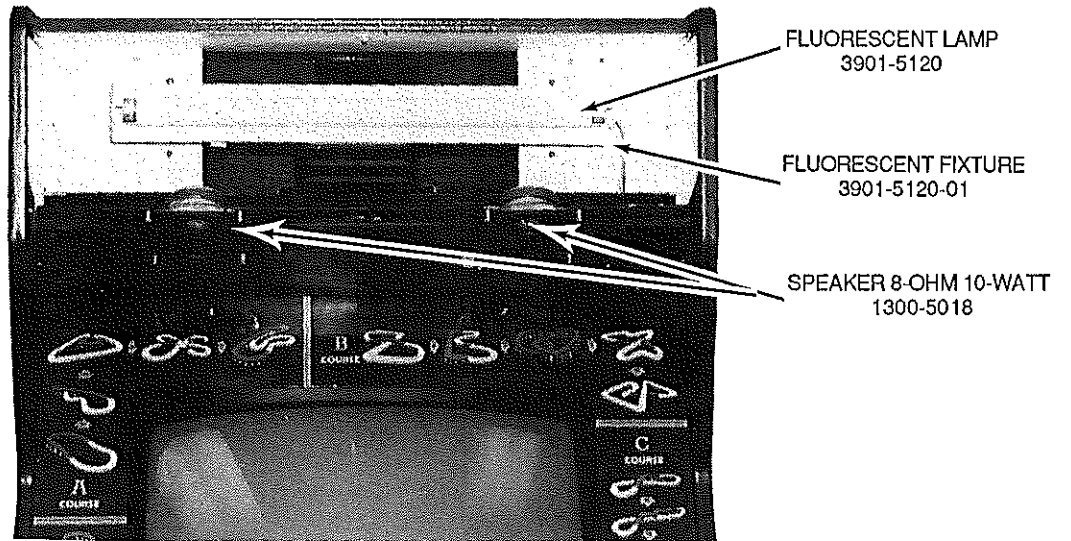
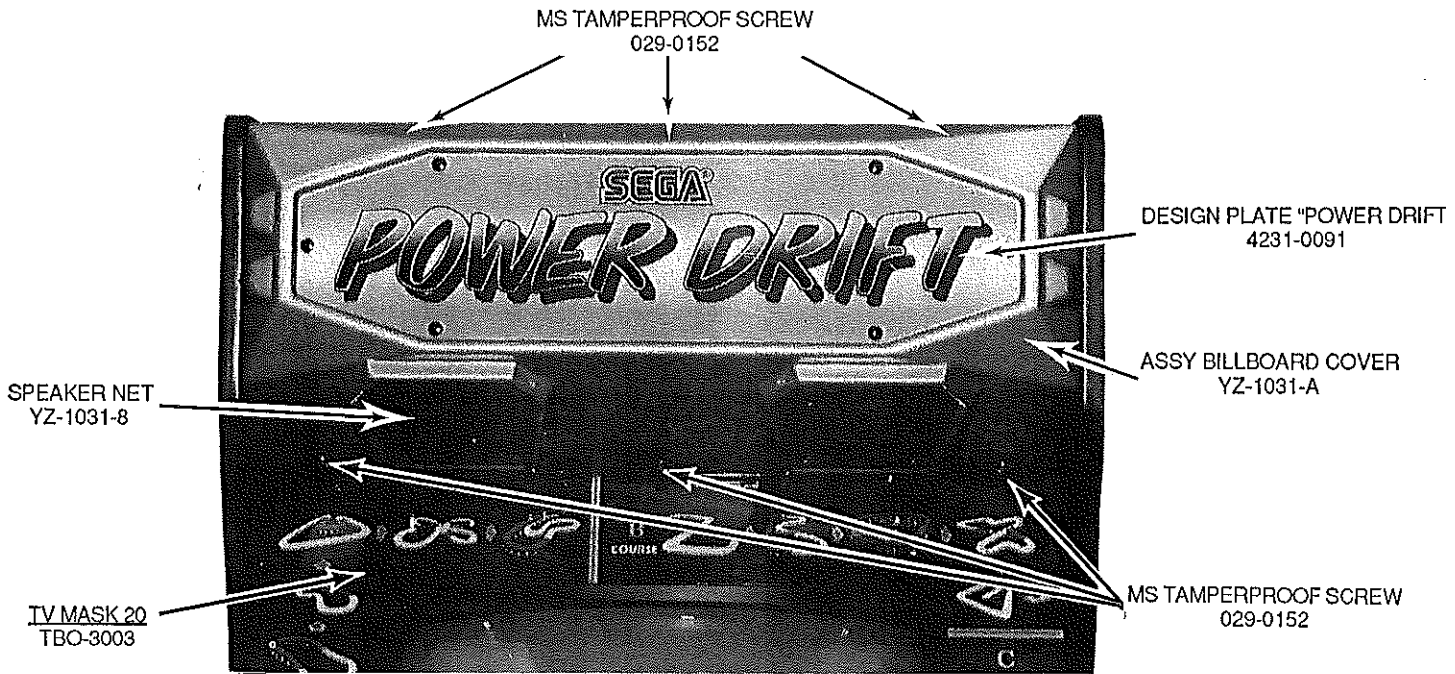

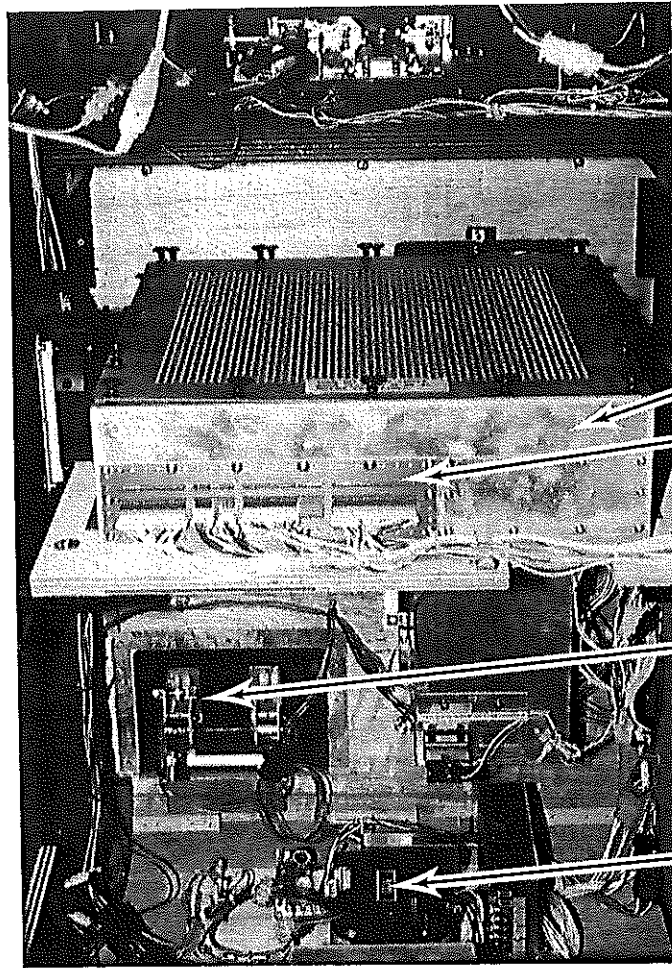

FCC CAGE ASSY & PCB

FILTER BD POWER DRIFT  
839-0207

ASSY ACCEL & BRAKE  
POW-2617

P/D U/R POWER SUPPLY ASSY

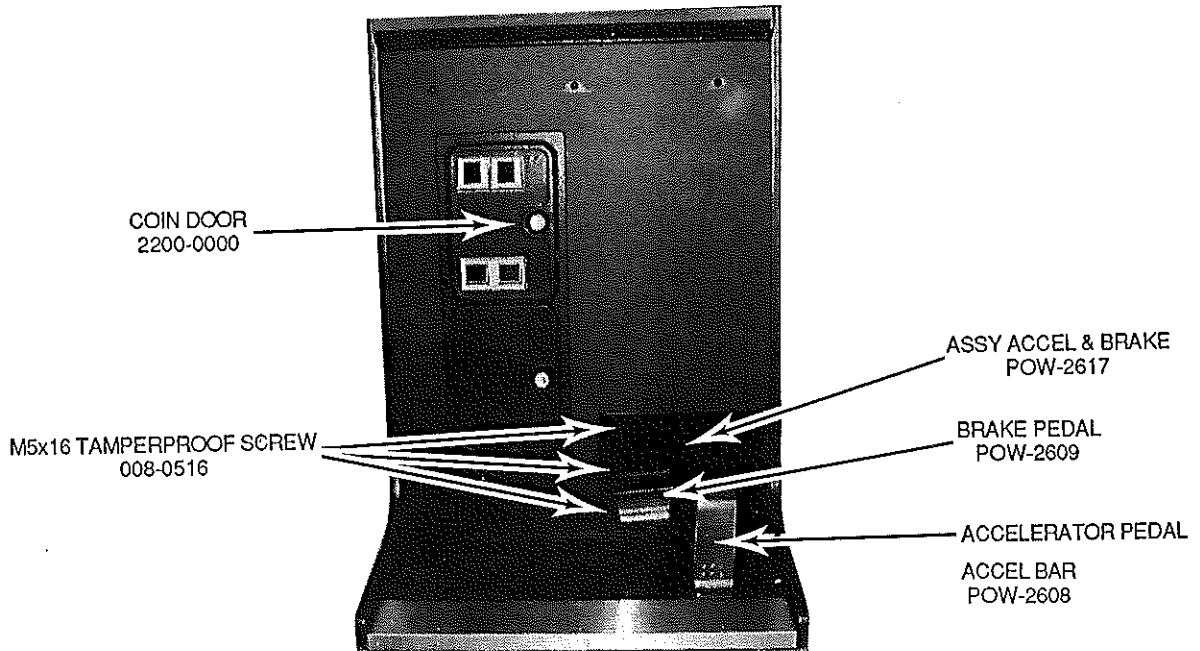

COIN DOOR  
2200-0000

M5x16 TAMPERPROOF SCREW  
008-0516

ASSY ACCEL & BRAKE  
POW-2617

BRAKE PEDAL  
POW-2609

ACCELERATOR PEDAL  
ACCEL BAR  
POW-2608

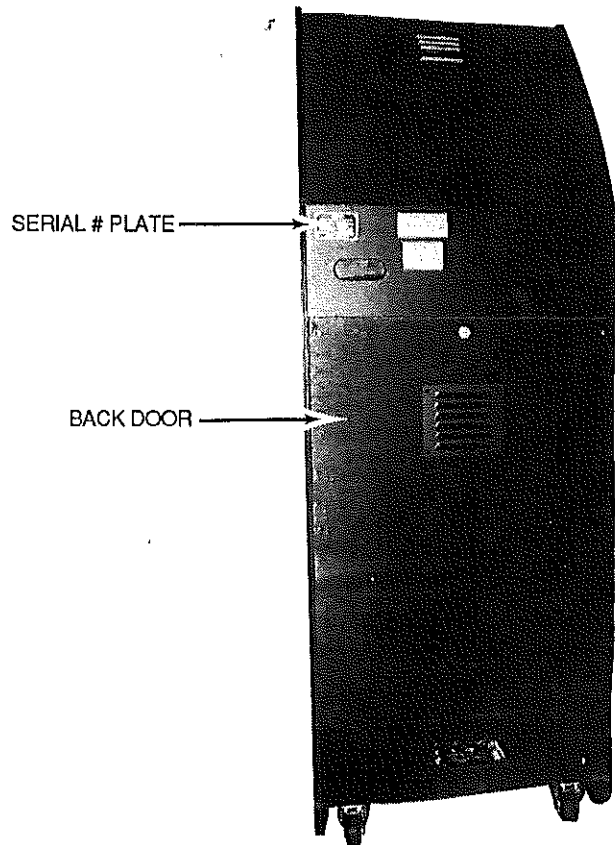
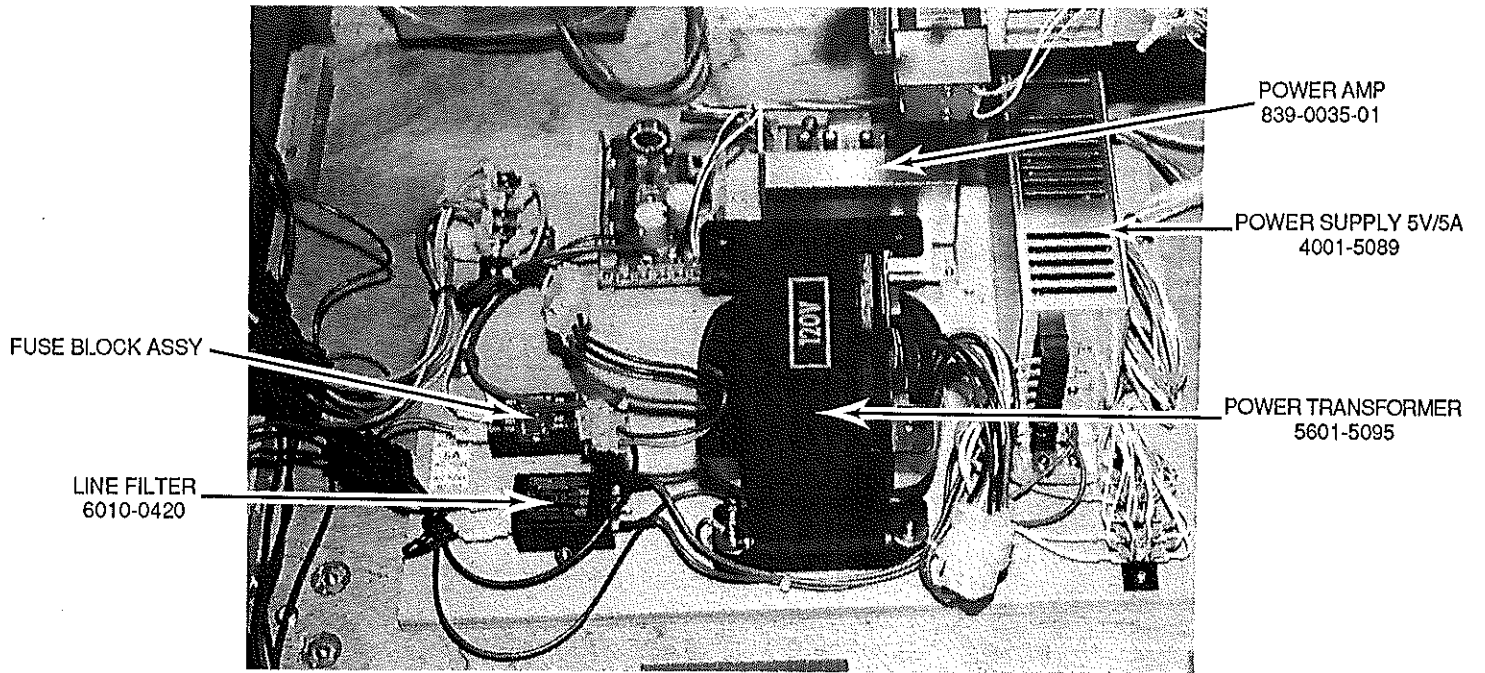



# 14. SCHEMATIC DIAGRAM

