

SPORTS ARENAs

SERVICE BULLETIN

NEW SPRING KIT for Prize Vending Unit to prevent shaking loose of Prizes !

HOW TO MOUNT THE SPRINGS.

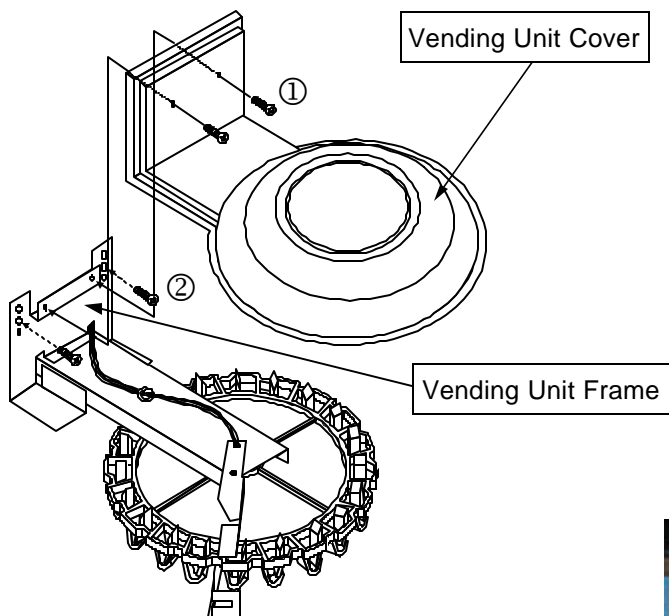

- 1) Remove the Prize Vending Unit from the Cabinet. (Refer to above picture.)
- 1 Take off 2 screws from the Vending Unit Cover.
- 2 Take off 2 screws from the Vending Unit Frame.
- 3 Remove the Connector which located on back side of Vending Unit to remove the Prize Vending Unit.

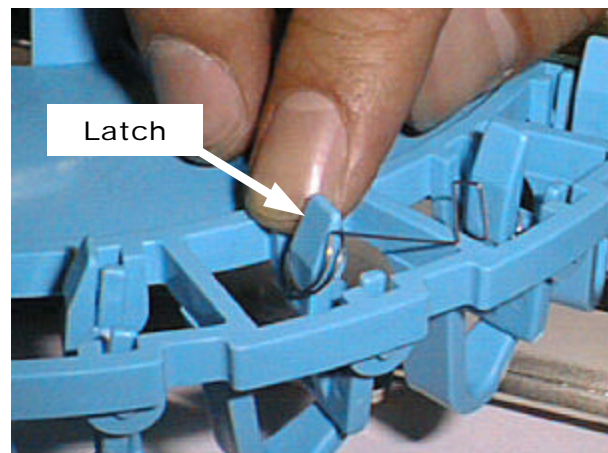
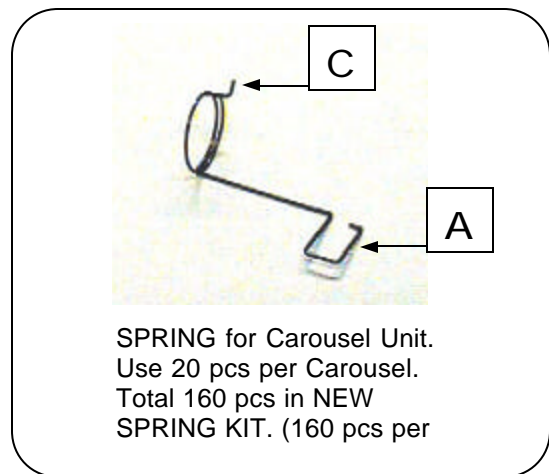

- 2) Place the SPRING as shown above. The Latch must go into the hole in the spring.

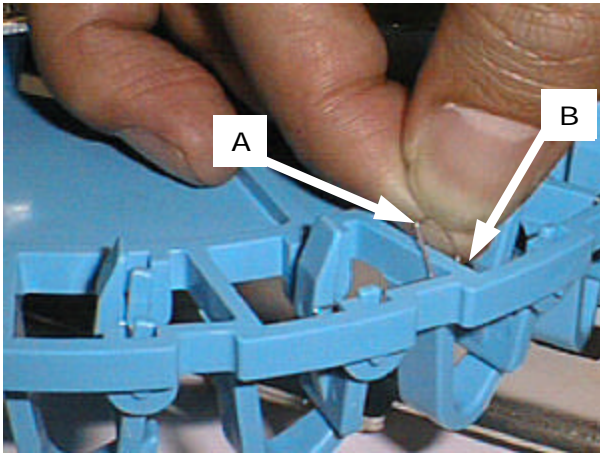
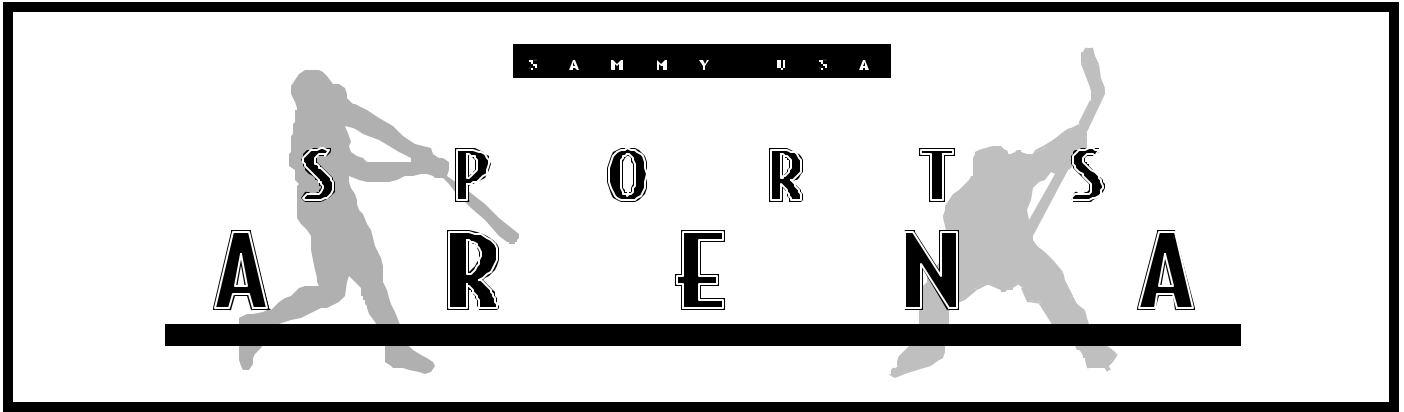

3) Hook part A of SPRING over part B of Hanger as far forward as possible.

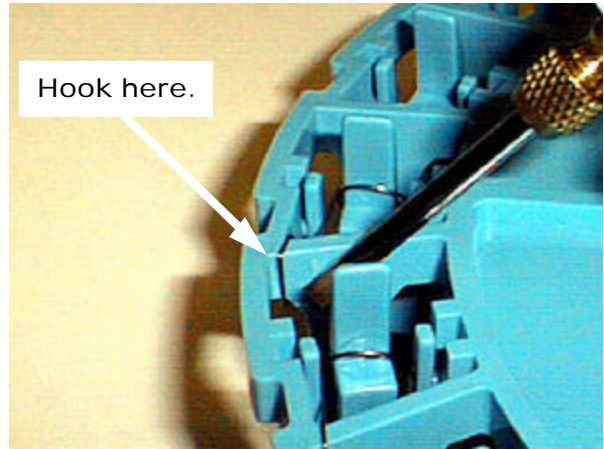

4) Use small screwdriver to hook correctly.

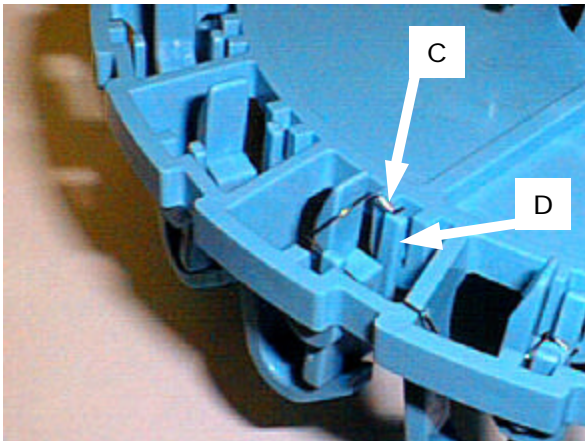

5) Hook part C of Spring to part D of Latch.

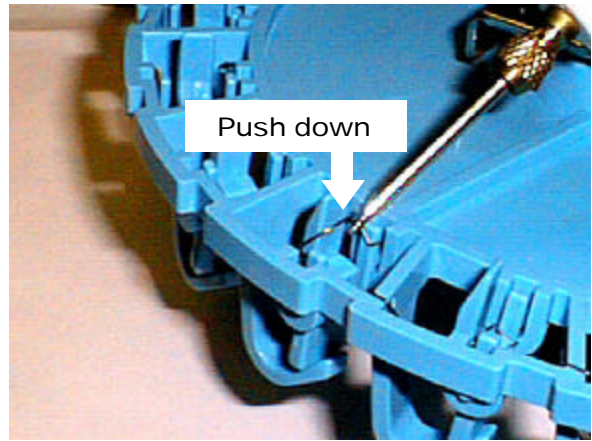

6) After Hooked, push down the Spring over Latch.

A R R E N A S P O R T S

COMPLETE!!!

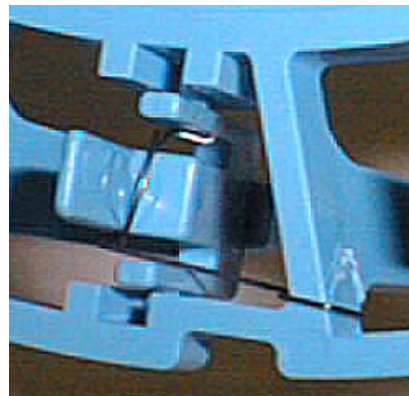
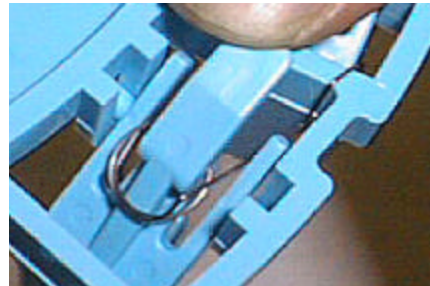
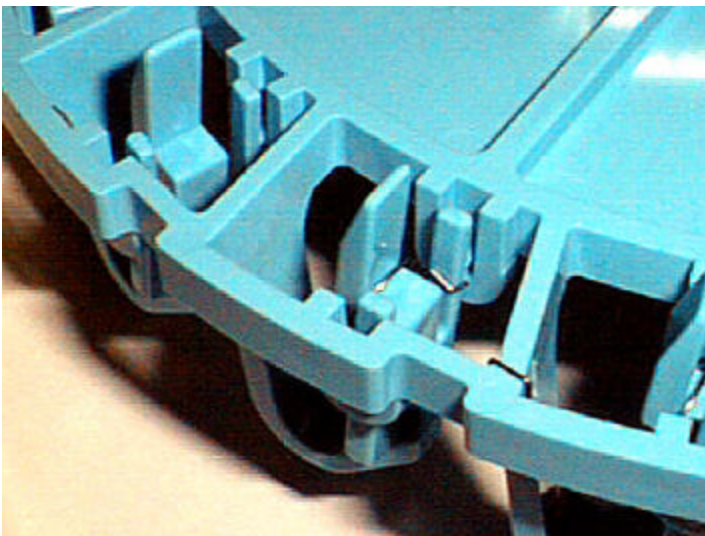

Spring

Hook here.

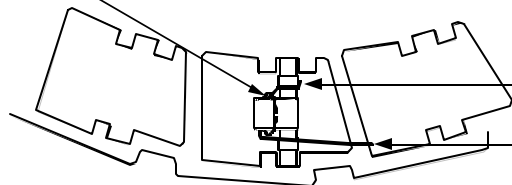

Top View of Latch & Spring

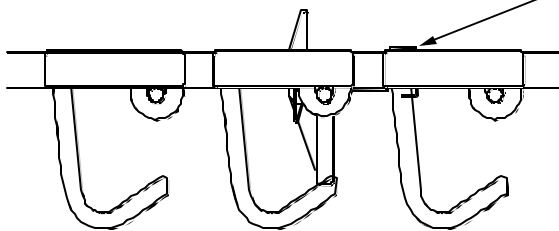

Front Side View of Latch & Spring

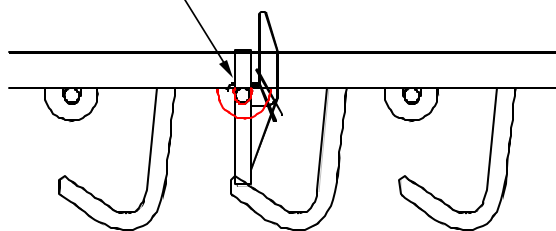

Back Side View of Latch & Spring