



THE FAST AND THE FURIOUS™

OPERATORS MANUAL

- Failure to properly operate this machine could result in malfunction or accident, so please read this manual carefully before commencing operation. Be sure to operate the machine as described in this manual.
- Keep this manual available and ready for use when necessary.
- If the machine fails to function correctly, immediately turn off the machine and

contact your local distributor. (60 Day Warranty, from date of purchase)



For Parts or Service contact your local Distributor or:

**Betson Enterprises
303 Paterson Plank Road
Carlstadt, New Jersey**



**Main Phone: (201) 438-1300
Toll Free Phone: (800) 524-2343
Part Phone: (800) 828-2048**

CAUTION:

- The specifications of this product are subject to change without notice for reasons such as performance.
- The content of this game, its main devices and design are protected under each federal law concerning patent, copyright and other intellectual properties.
- Unauthorized reproduction of this document or any of its contents is strictly forbidden.

Safety Instructions

Safety instructions apply to operators and service personnel. Read these instructions before preparing the video game machine for play. Other safety instructions appear throughout this manual.

WARNING: TRANSPORTING THE VIDEO GAME MACHINE (VGM).

The VGM contains glass and fragile electronic devices. Use appropriate care when transporting . Avoid rough handling when moving the VGM.

WARNING: DISCONNECT POWER.

Always turn the power OFF and unplug the VGM before attempting service or adjustments unless otherwise instructed. Installing or repairing components with the power switched ON can damage the components an void warranty.

WARNING: GROUND GAMES.

Avoid electrical shock! Do not plug in the VGM until you have inspected and properly grounded it. Only plug into a grounded, three-wire outlet. Do not use a "cheater" plug, or cut off the ground pin on the line cord.

WARNING: AVOID ELECTRICAL SHOCKS.

This VGM does not utilize an isolation transformer. Internal cabinet AC is not isolated from the external AC line.

WARNING: HANDLE FLOURESCENT TUBE AND CRT WITH CARE.

If you drop a fluorescent tube or CRT and it breaks, it will implode! Shattered glass can fly eight feet or more from the implosion.

WARNING: CHECK POWER SELECTOR, LAMP.

Set the 115/230 VAC selector switch on the power supply for the correct line voltage on the installation site. Verify that the fluorescent lamps are rated for the proper line voltage.

WARNING: USE PROPER FUSE.

Avoid electrical shock! Replacement fuses must be identically rated to the original fuse!

WARNING: ATTACH CONNECTORS PROPERLY.

Be sure all connectors mate properly. If connectors do not slip in easily, do not force them. Connectors are often keyed and only connect one way. Check for correct orientation.

WARNING: USE EXTREME CARE WHEN HANDLING PC.

The PC contains sensitive components such as a hard drive. Do not handle roughly. Call your distributor before servicing PC internal components. Ask about warranty information as it relates to the PC.

WARNING: HAZARD TO EPILEPTICS.

A very small portion of the population has a condition which may cause them to experience epileptic seizures or have momentary loss of consciousness when viewing certain kinds of flashing lights or patterns that are present in our daily environment. These persons may experience seizures while watching some kinds of television pictures or playing certain video games. Peoples who have not had any previous seizures may nonetheless have an undetected epileptic condition.

If you or anyone in your family has experienced symptoms linked to an epileptic condition (e.g., seizures or loss of awareness), immediately consult your physician before using any video games.

We recommend that parents observe their children while they play video games. If you or your child experience the following symptoms: dizziness, altered vision, eye or muscle twitching, involuntary movements, loss of awareness, disorientation, or convulsions, DISCONTINUE USE IMMEDIATELY and consult your physician.



PRODUCT SPECIFICATIONS

OPERATING REQUIREMENTS

ELECTRICAL POWER

Domestic 120VAC @ 60 Hz, 5 amps
Foreign 240VAC @ 50Hz, 2.5 amps

TEMPERATURE

32° F to 100°F
(0°C to 38°C)

HUMIDITY

Not to exceed 95% relative humidity.

27 INCH SITDOWN MODEL MAIN CABINET SHIPPING DIMENSIONS

Height = 83 ¾ INCHES (212.72 cm)
Depth = 39 inches (99.06 cm)
Width = 37 inches (93.98 cm)

27 INCH SITDOWN MODEL MAIN CABINET SHIPPING WEIGHT

Weight = 495 lbs. (224.53 Kg)

27 INCH SEAT SHIPPING DIMENSIONS

Height = 54 inches (137.16 cm)
Depth = 23 ¾ inches (60.33 cm)
Width = 35 ½ inches (90.17 cm)

27 INCH MODEL SEAT SHIPPING WEIGHT

Weight = 125 lbs. (57.04Kg)

INSPECTION AND INSTALLATION

WARNING: Use extreme care when moving or servicing the game cabinet. Don't plug in the game until you have read this manual.

Please check the following after the game after the game has been removed from its shipping crate and placed in a suitable play or service area.

Make sure that the game cabinet is level. Adjust the casters as needed.

1. Check the AC line cord for any visible signs of damage to the plug or line cord insulation.
2. Check for possible shipping damage to the following:

- Player interfaces: steering wheel, buttons, keypad and shifter.
 - Seat assembly.
 - Monitor glass.
 - Cabinet backdoor.
 - Cabinet coin door.
 - Cabinet and seat decals.
3. Remove the coin door key from the coin return chute.
 4. Open the top coin door and locate the key for the backdoor and the cashbox.
 5. Locate hardware kit: tamper proof tool kit
 - crossover network cable
 - line cord
 - seat hardware fasteners (8 sets)
 6. Remove the backdoor the backdoor from the cabinet and visually inspect the electronic components.
 7. Verify that all connectors are secure and that the bottom of the cabinet is free of loose objects which may have possibly come loose during shipping.

Seat Assembly Procedure

WARNING: The cabinet is top heavy. Install only on level surface. Use the leg levelers to make sure the cabinet and seat are stable. Do not push against plastic parts during movement.

1. Roll the cabinet and seat to the intended location and lower the leg levelers until both are equal height and stable.
2. Reach inside the base of the cabinet remove the bolts to fasten a mounting rail to the cabinet and set aside. Individually pull the rail out, flip it end over end and reinsert it. Fasten the rail to the inside of the cabinet with bolts until finger tight; some movement is required in the mounting rails to align holes with seat pedestal assembly. Repeat for the mounting rail on the other side. See diagram.

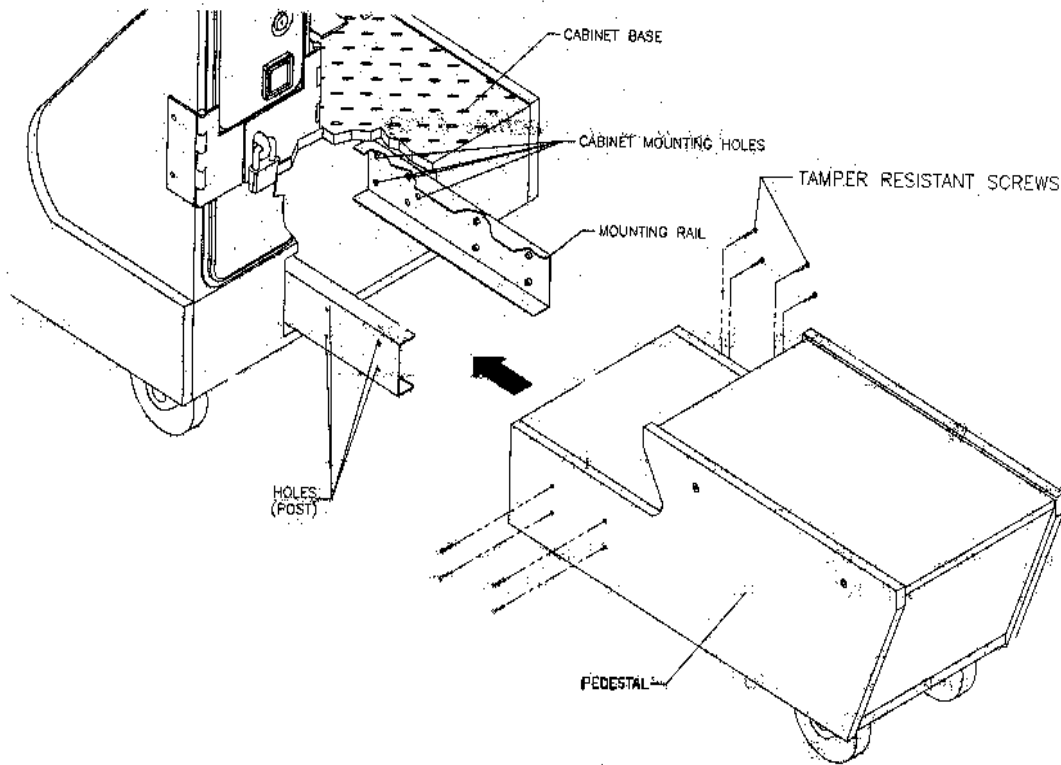

3. Roll the pedestal near the cabinet and align the opening in the pedestal with the ends of the rails. Slide the pedestal forward onto the rails leaving enough space to attach the wiring harness. Mate each cable connector and press firmly to seat the contacts. Ensure no wires are pinched during the pedestal attachment. Fasten in place with the 1/4" X 20 tamper resistant screws and large flat washers provided.
4. Tighten the screws firmly with the wrench provided, and then tighten the bolts for the mounting rails.
5. Adjust all levelers until both cabinet and seat are flush and parallel with each other. Inspect for pinched wires before firmly tightening the remaining fasteners to attach the two pieces as one.

Power Up Procedure

1. Plug the game line cord into an appropriately wired and fused AC receptacle.
2. Locate the game AC main switch to the bottom left side on back of the game cabinet.
3. Turn the switch to the ON position.
4. The game attract feature will begin after the game is finished loading- approximately 1 minute.
5. Proceed to Switch Test of this document and verify proper game operation.

Game Networking

NOTICE: To link two games together, use the crossover cable provided in the spare parts bag. Use of another cable other than the one shipped with the game could void warranty or cause games not to link. Use network cables which are at least CAT5 grade.

Networking Considerations

Each FNF game comes with a crossover network cable. This cable is specifically designed to connect two games directly to each other.

If you are linking more than two games, you must purchase 1 regular CAT5 cable per game and a NETWORK SWITCH (NOT a hub). A linking kit, including these parts, is also available from your distributor.

Take care to protect exposed game wiring from general foot traffic around the game. Use a conduit or wire way to protect the cables as needed.

Please mark linking cables for your game if other such cables are in the vicinity to avoid confusion. Network cables are not marked or coded.

Avoid routing the network cables near sources of heat, moisture or electrical energy such as neon lights, compressor motors, transformers etc.

Networking Setup (2 games)

1. Remove the network cable from the spare parts bag inside the cashbox.
2. If you are linking two games, connect each end of the cable to network jack behind each PC:

[BACK OF COMPUTER]

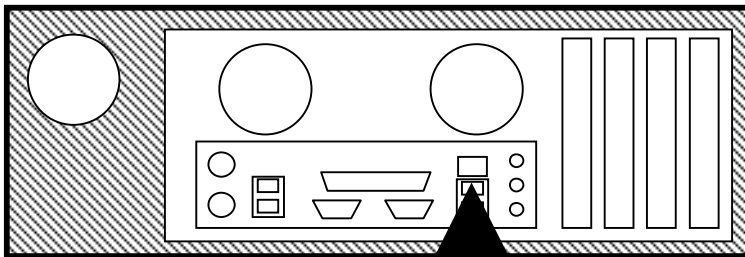

CONNECT NETWORK CABLE HERE

3. Neatly route the cable through the notch on the back of the cabinet.
4. Use the DIP switch diagram below for enabling link feature and master/slave configuration. The DIP switch is located on the JAMMA I/O board. The JAMMA I/O board is mounted inside the back of the cabinet.
5. Reset all games simultaneously and verify that link is successful. If not, check the DIP switch settings and make sure that the network cable is connected properly and secured. Please refer to the Game Troubleshooting Guide on this manual for more details.

DIP SWITCH DIAGRAM:

DIP SW#	SW1	SW2	SW3	SW4	SW5	SW6	SW7	SW8
PLAYER 1 / MASTER	OFF	OFF	OFF				*	ON
PLAYER 2	ON	OFF	OFF				*	ON

* NOTE: This switch should be OFF for a Sitdown cabinet, ON for an Upright.

Networking Setup (3 or more games)

1. Get a regular (NOT crossover) CAT5 cable for each machine, 12' or longer depending on your physical configuration. Also, get a networking switch (NOT hub).
2. Connect one end of each cable to the back of each game's PC network port:

[BACK OF COMPUTER]

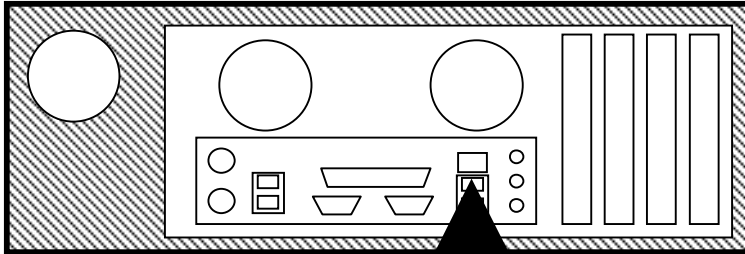

**CONNECT NETWORK CABLE
HERE**

3. Connect the other end of each cable to the networking switch.
4. On each game, neatly route the cable through the notch on the back of the cabinet.
5. Use the DIP switch diagram below for enabling link feature and master/slave configuration. The DIP switch is located on the JAMMA I/O board. The JAMMA I/O board is mounted inside the back of the cabinet.
6. Reset all games simultaneously and verify that link is successful. If not, check the DIP switch settings and make sure that the network cable is connected properly and secured. Please refer to the Game Troubleshooting Guide on this manual for more details.

DIP SWITCH DIAGRAM:

DIP SW#	SW1	SW2	SW3	SW4	SW5	SW6	SW7	SW8
PLAYER 1 / MASTER	OFF	OFF	OFF				*	ON
PLAYER 2	ON	OFF	OFF				*	ON
PLAYER 3	OFF	ON	OFF				*	ON
PLAYER 4	ON	ON	OFF				*	ON
PLAYER 5	OFF	OFF	ON				*	ON
PLAYER 6	ON	OFF	ON				*	ON
PLAYER 7	OFF	ON	ON				*	ON
PLAYER 8	ON	ON	ON				*	ON

* NOTE: This switch should be OFF for a Sitdown cabinet, ON for an Upright.

SETUP AND TEST MENU

Locate the *Service Button Panel*. It is mounted inside the coin door area on top of the cash box vault. Press the **TEST** button to access the **Test Menu**.

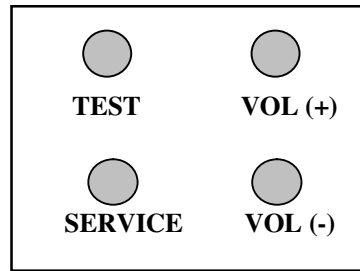

Menu Navigation:

Button	Action
Test	Enter Operator Screen
Start Button	Enter/Select Item Sub-Menu
Vol. (+) or View 1 Button	Scroll up thru Menu items
Vol. (-) or View 3 Button	Scroll down thru Menu items
Service or Tunes	Exit to previous Menu

MAIN MENU

The **Test Main Menu** appears when the **TEST** button is pressed.

<p>Test Main Menu</p> <p>Diagnostics Game Audits Adjustments Utilities</p> <p>Calibration Volume Messages Exit</p>	<p>Version Information</p> <p>Date : July 2 2004 Version: 0.0.0 Build: 1 Machine ID: 1 JUSB Ver.: Debug 7f</p>
---	---

**Press Volume +/- or View 1/3 to Select
Press Test or Start to Activate
Press Service or Tunes to Exit**

Diagnostics Menu

From the **Main Menu**, select **Diagnostics** and enter to view options.

<p>Diagnostics Menu</p> <p>Switch Test DIP Switch Test Sound Test Wheel Test Monitor Test Lamp Test Coin Meter Test Watchdog Test</p> <p>Exit</p>	<p>Diagnostics</p>
<p>Press Volume +/- or View 1/3 to Select Press Test or Start to Activate Press Service or Tunes to Exit</p>	

Switch Test

From the **Diagnostics** select and enter **Switch Test**. Verify proper switch input function using this menu. Each switch activated will be indicated on the test screen in corresponding yellow box and will be accompanied by a switch active sound indicator. Verify pot value for min, center and max are correct. If not, proceed to Calibration section of this manual. Press and hold the **Service Button** for three seconds to return to the **Diagnostics Menu**.

SWITCH TEST																																			
<table border="1" style="width: 100%; border-collapse: collapse;"> <tr> <th colspan="3" style="text-align: left; padding: 2px;"><u>Wheel / Pedal Info</u></th> </tr> <tr> <th style="text-align: left; padding: 2px;">Input Device</th> <th style="text-align: left; padding: 2px;">Pot Value</th> <th style="text-align: left; padding: 2px;">Min Center Max</th> </tr> <tr> <td style="padding: 2px;">Wheel</td> <td style="padding: 2px;"><input style="width: 100%;" type="text"/></td> <td style="padding: 2px;"></td> </tr> <tr> <td style="padding: 2px;">Gas</td> <td style="padding: 2px;"><input style="width: 100%;" type="text"/></td> <td style="padding: 2px;"></td> </tr> <tr> <td style="padding: 2px;">Brake</td> <td style="padding: 2px;"><input style="width: 100%;" type="text"/></td> <td style="padding: 2px;"></td> </tr> </table>			<u>Wheel / Pedal Info</u>			Input Device	Pot Value	Min Center Max	Wheel	<input style="width: 100%;" type="text"/>		Gas	<input style="width: 100%;" type="text"/>		Brake	<input style="width: 100%;" type="text"/>																			
<u>Wheel / Pedal Info</u>																																			
Input Device	Pot Value	Min Center Max																																	
Wheel	<input style="width: 100%;" type="text"/>																																		
Gas	<input style="width: 100%;" type="text"/>																																		
Brake	<input style="width: 100%;" type="text"/>																																		
<table border="1" style="width: 100%; border-collapse: collapse;"> <tr> <th colspan="2" style="text-align: left; padding: 2px;"><u>Button Info</u></th> </tr> <tr> <td style="padding: 2px;">1</td> <td rowspan="9" style="text-align: center; vertical-align: middle;"><input style="width: 100%; height: 100%;" type="text"/></td> </tr> <tr><td style="padding: 2px;">2</td></tr> <tr><td style="padding: 2px;">3</td></tr> <tr><td style="padding: 2px;">Tunes</td></tr> <tr><td style="padding: 2px;">Start</td></tr> <tr><td style="padding: 2px;">Handbrake</td></tr> <tr><td style="padding: 2px;">Coin 1</td></tr> <tr><td style="padding: 2px;">Coin 2</td></tr> <tr><td style="padding: 2px;">Bill</td></tr> </table>	<u>Button Info</u>		1	<input style="width: 100%; height: 100%;" type="text"/>	2	3	Tunes	Start	Handbrake	Coin 1	Coin 2	Bill	<table border="1" style="width: 100%; border-collapse: collapse;"> <tr> <th colspan="2" style="text-align: left; padding: 2px;"><u>Shift Info</u></th> </tr> <tr> <td style="padding: 2px;">One</td> <td style="padding: 2px;">Three</td> </tr> <tr> <td style="padding: 2px;">Two</td> <td style="padding: 2px;">Four</td> </tr> </table>	<u>Shift Info</u>		One	Three	Two	Four	<table border="1" style="width: 100%; border-collapse: collapse;"> <tr> <th colspan="3" style="text-align: left; padding: 2px;"><u>Keypad Info</u></th> </tr> <tr> <td style="padding: 2px;">1</td> <td style="padding: 2px;">2</td> <td style="padding: 2px;">3</td> </tr> <tr> <td style="padding: 2px;">4</td> <td style="padding: 2px;">5</td> <td style="padding: 2px;">6</td> </tr> <tr> <td style="padding: 2px;">7</td> <td style="padding: 2px;">8</td> <td style="padding: 2px;">9</td> </tr> <tr> <td style="padding: 2px;">*</td> <td style="padding: 2px;">0</td> <td style="padding: 2px;">#</td> </tr> </table>	<u>Keypad Info</u>			1	2	3	4	5	6	7	8	9	*	0	#
<u>Button Info</u>																																			
1	<input style="width: 100%; height: 100%;" type="text"/>																																		
2																																			
3																																			
Tunes																																			
Start																																			
Handbrake																																			
Coin 1																																			
Coin 2																																			
Bill																																			
<u>Shift Info</u>																																			
One	Three																																		
Two	Four																																		
<u>Keypad Info</u>																																			
1	2	3																																	
4	5	6																																	
7	8	9																																	
*	0	#																																	
<table border="1" style="width: 100%; border-collapse: collapse;"> <tr> <th colspan="2" style="text-align: left; padding: 2px;"><u>TVV Info</u></th> </tr> <tr> <td style="padding: 2px;">Service Credit</td> <td style="padding: 2px;"></td> </tr> <tr> <td style="padding: 2px;">Vol+</td> <td style="padding: 2px;"></td> </tr> <tr> <td style="padding: 2px;">Vol-</td> <td style="padding: 2px;"></td> </tr> <tr> <td style="padding: 2px;">Test</td> <td style="padding: 2px;"></td> </tr> </table>	<u>TVV Info</u>		Service Credit		Vol+		Vol-		Test		<table border="1" style="width: 100%; border-collapse: collapse;"> <tr> <th colspan="2" style="text-align: left; padding: 2px;"><u>Software Info</u></th> </tr> <tr> <td style="padding: 2px;">Date: July 28, 2004</td> <td style="padding: 2px;"></td> </tr> <tr> <td style="padding: 2px;">Time: 15.03:29</td> <td style="padding: 2px;"></td> </tr> <tr> <td style="padding: 2px;">Ver: 0.3.1</td> <td style="padding: 2px;"></td> </tr> <tr> <td style="padding: 2px;">Build: 1</td> <td style="padding: 2px;"></td> </tr> <tr> <td style="padding: 2px;">ID: 4</td> <td style="padding: 2px;"></td> </tr> </table>		<u>Software Info</u>		Date: July 28, 2004		Time: 15.03:29		Ver: 0.3.1		Build: 1		ID: 4												
<u>TVV Info</u>																																			
Service Credit																																			
Vol+																																			
Vol-																																			
Test																																			
<u>Software Info</u>																																			
Date: July 28, 2004																																			
Time: 15.03:29																																			
Ver: 0.3.1																																			
Build: 1																																			
ID: 4																																			

DIP Switch Test

From the **Diagnostics Menu** select and enter **DIP Switch Test**. Verify correct DIP switch settings. Please refer to Appendix n. Press the Tunes Button to return to **Diagnostics Menu**.

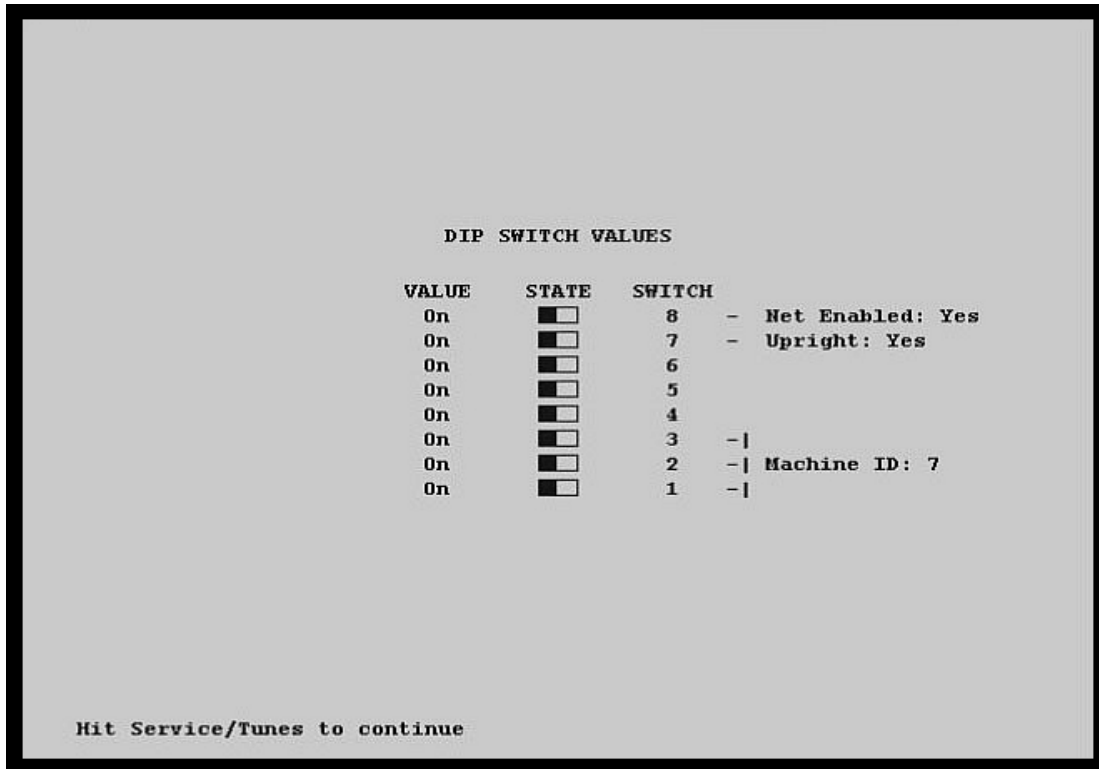

Sound Test

From the **Diagnostics Menu** select and enter **Sound Test**. Verify that marquee, cabinet and seat sound volume and quality are good. Press the Tunes Button to return to **Diagnostics Menu**

<p>Sound Test Menu</p> <p>Change Music Change Effect</p> <p>Play 100Hz Test Play 1000Hz Test</p> <p>Set Pan Center Set Pan Left Set Pan Right</p> <p>Exit</p>	<p>Sound Test</p> <p>Current Music Track:</p> <p>Current Sound Effect:</p>	<p>Note: Use Pan functions to test left/right speakers separately.</p> <p>Use 100-1Khz test to verify subwoofer sound quality.</p> <p>Go to Volume section to adjust sound level.</p>
<p>Press Volume +/- or View 1/3 to Select Press Test or Start to Activate Press Service or Tunes to Exit</p>		

Wheel Test

Caution: Begin by placing the wheel at center position. The steering wheel moves automatically during the wheel test. Stay clear of the wheel!

From the **Diagnostics Menu** select and enter **Wheel Test**. Verify proper wheel force feedback function using this menu. Follow the screen instruction carefully.

Wheel Test

- Hit Test/Start To Begin
- Turning Wheel Left
- Hit Start/Test To Coninue
- Turning Wheel Right
- Hit Test /Start To Exit

Monitor Test

From the **Audio/Video Options** menu, select and enter **Color Bars & Purity**. Verify correct color and purity for Red, Blue and Green screens. Use the convergence screen to also verify linearity. See Appendix n.

- White Screen

- Red Screen

- Green Screen

- Blue Screen

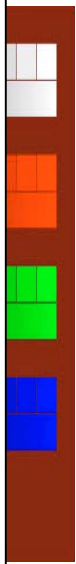

Purity Screen

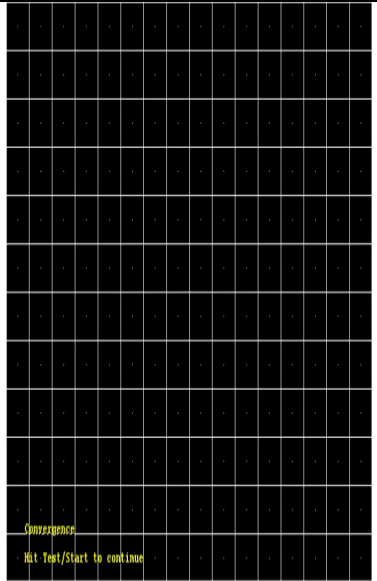

Convergence

Lamp Test

From the ***Diagnostics Menu*** select and enter ***Lamp Test***. Use View1 or View 3 to select the lamp and press Star activate that lamp. Verify that ALL lamps are working.

<p>Lamp Test Menu</p> <p>ALL Lamps ON ALL Lamps OFF 1 Lamp ON 2 Lamp ON 3 Lamp ON Tunes Lamp ON Start Lamp ON</p> <p>Exit</p>	<p>Lamp Test</p>
<p>Press Volume +/- or View 1/3 to Select Press Test or Start to Activate Press Service or Tunes to Exit</p>	

Note:

Lamp function could also be verified using Switch Test.

Please check the coin door lamps as part of your game diagnostic check.

Coin Meter Test

From the ***Diagnostics Menu*** select and enter ***Coin Meter Test***. Advance the meter once using by pressing Start.

Press the Tunes Button to return to ***Diagnostics Menu***.

Hit Test/Start to advance coin meter.

Press Service or Tunes to Exit

Watchdog Test

From the ***Diagnostics Menu*** select and enter ***Watchdog Test***. The game will reset in approximately 6 seconds.

The watchdog feature allows the PC to monitor normal game software and hardware operation.



Game Audits

From the *Main Menu*, select *Game Audits* and enter to view options.

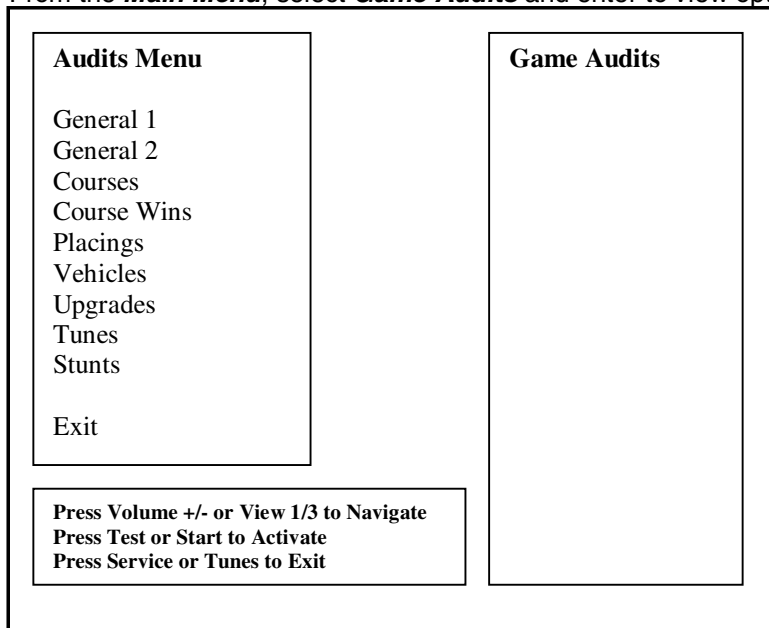

Note:

- Use game audit screens to assess game performance.
- Use information to determine options such as game difficulty and free game award to maximize game earnings.
- Use information to detect possible intermittent problems.

General 1 Audits

From the **Audits Menu**, select **General 1** and enter to view general game statistics. Press the Tunes Button to return to **Main Menu**.

<p>Audits Menu</p> <p><u>General 1</u> General 2 Courses Course Wins Placings Vehicles Upgrades Tunes Stunts</p> <p>Exit</p>	<p>General Audits</p> <p>Time Game On Time Game Played Average Time Per Game</p> <p>Games Played Games Started Game Continued Game Timed Out Free Games PIN Games Link Games</p> <p>Boot Ups Test Mode Entries Unfinished Games</p>
<p>Press Volume +/- or View 1/3 to Navigate Press Test or Start to Activate</p>	

General 2 Audits

From the **Audits Menu**, select **General 2** and enter to view additional general game statistics. Press the Tunes Button to return to **Main Menu**.

<p>Audits Menu</p> <p>General 1 <u>General 2</u> Courses Course Wins Placings Vehicles Upgrades Tunes Stunts</p> <p>Exit</p>	<p>General Audits</p> <p>Auto Games Manual Games</p> <p>1st Person Cam Game Behind Cam Game Behind Cam High Game</p> <p>Coindrops Coindrops Slot 0 Left Coindrops Slot 1 Right Coindrops Slot 2 DBV</p> <p>Current Credits Current Coins</p>
<p>Press Volume +/- or View 1/3 to Navigate Press Test or Start to Select Press Service or Tunes to Exit</p>	

Course Audits

From the **Audits Menu**, select **Courses** and enter to view individual information on each course. View how many times each course is selected, as well as its popularity by overall percentage. Press the Tunes Button to return to **Main Menu**.

<p>Audits Menu</p> <p>General 1 General 2 <u>Courses</u> Course Wins Placings Vehicles Upgrades Tunes Stunts</p> <p>Exit</p>	<p>Course Selects/Percentage</p> <p>Time Square Mojave ChinaEZ Malibu Central Park Ghetto Golden Gate New England Hollywood SF Tour ChinaEX MDrive</p>
<p>Press Volume +/- or View 1/3 to Navigate Press Test or Start to Slect Press Service or Tunes to Exit</p>	

Course Wins Audit

From the ***Audits Menu***, select ***Courses Wins*** and enter to view individual win and overall percentage information on each course. Press the Tunes Button to return to ***Main Menu***.

<p>Audits Menu</p> <p>General 1 General 2 Courses <u>Course Wins</u> Placings Vehicles Upgrades Tunes Stunts</p> <p>Exit</p>	<p>Course Wins/Percentage</p> <p>Time Square Mojave ChinaEZ Malibu Central Park Ghetto Golden Gate New England Hollywood SF Tour ChinaEX MDrive</p>
<p>Press Volume +/- or View 1/3 to Navigate Press Test or Start to Select Press Service or Tunes to Exit</p>	

Placings Audit

From the ***Audits Menu***, select ***Placings*** and enter to view individual count for each standing and percentage information. Use this information to determine game difficulty adjustments to properly reward players and maximize game earning performance. Press the Tunes Button to return to ***Main Menu***.

<p>Audits Menu</p> <p>General 1 General 2 Courses Course Wins <u>Placings</u> Vehicles Upgrades Tunes Stunts</p> <p>Exit</p>	<p>Placings/Percentage</p> <p>1st Place 2nd Place 3rd Place 4th Place 5th Place 6th Place 7th Place 8th Place</p> <p>Avg. Place:</p> <p>Longest Winning Streak: Longest Lose Streak: Current Win Streak: Current Lose Streak:</p>
<p>Press Volume +/- or View 1/3 to Navigate Press Test or Start to Select Press Service or Tunes to Exit</p>	

Vehicles Audit

From the ***Audits Menu***, select ***Vehicles*** and enter to view individual count for each vehicle selection and percentage information. Press the Tunes Button to return to ***Main Menu***.

<p>Audits Menu</p> <p>General 1 General 2 Courses Course Wins Placings <u>Vehicles</u> Upgrades Tunes Stunts</p> <p>Exit</p>	<p>Vehicle Selects/Percentage</p> <p>Supra 350Z Firebird Eclipse S2000 RX 8 Skyline RSX GTO EVO RX 7 Charger Corvette 240SX Pershing 500 Spyder 738 RPG 360 AKX 470</p>
<p>Press Volume +/- or View 1/3 to Navigate Press Test or Start to Select Press Service or Tunes to Exit</p>	

Upgrade Audit

From the **Audits Menu**, select **Upgrades** and enter to view individual count for each vehicle feature upgrade selection and percentage information. Press the Tunes Button to return to **Main Menu**.

<p>Audits Menu</p> <p>General 1 General 2 Courses Course Wins Placings Vehicles <u>Upgrades</u> Tunes Stunts</p> <p>Exit</p>	<p>Upgrades/Percentage</p> <p>Nitro Spoiler Decal Tires Ground Effects Engine</p> <p>Upgrade Users:</p>
<p>Press Volume +/- or View 1/3 to Navigate Press Test or Start to Select Press Service or Tunes to Exit</p>	

Tunes Audit

From the **Audits Menu**, select **Tunes** and enter to view individual count for each tune selection and playtime information. Press the Tunes Button to return to **Main Menu**

<p>Audits Menu</p> <p>General 1 General 2 Courses Course Wins Placings Vehicles Upgrades <u>Tunes</u> Stunts</p> <p>Exit</p>	<p>Tunes (Time in Each)</p> <p>Asia Spin Off Put the Tires Up DNB Fire It Up Lets Ride Outlaw Breaks Sweeps</p>
<p>Press Volume +/- or View 1/3 to Navigate Press Test or Start to Select Press Service or Tunes to Exit</p>	

Stunts Audit

From the **Audits Menu**, select **Stunts** and enter to view individual count for each stunt performed. Press the Tunes Button to return to **Main Menu**

<p>Audits Menu</p> <p>General 1 General 2 Courses Course Wins Placings Vehicles Upgrades Tunes <u>Stunts</u> Exit</p>	<p>Stunts</p> <p>Wheelies Side Wheelies Flips Helis Rolls Vaults End Over Ends Spin Outs Slides Resets Bumps Landing Spins Nitros Manual Spins</p>
<p>Press Volume +/- or View 1/3 to Navigate Press Test or Start to Activate Press Service or Tunes to Exit</p>	

Adjustment Menu

From the **Main Menu**, select **Adjustment Menu** and enter. The Adjustment Menu allows you to customize the game. Each variable will change an aspect of the game play and appearance. Optimizing these settings should result in continued high player interest and game earnings. You can monitor the affects of these options by comparing audit information before and after the changes have been implemented. Press Start to Select. Press Tunes or Service to Exit.

<p>Adjustments Menu</p> <p>Pricing Freeplay 1st Place-Free Race Start Time Bonus Checkpoint Time Bonus Attract Audio Speed Measurements Starting Line Girls Game Difficulty Max Credits Multiplay Win Gets Free Game Max Name Length Exploding Cars Plays For High Score Reset Exit</p>	<p>Preference And Adjustments</p>
<p>Press Volume +/- or View 1/3 to Navigate Press Test or Start to Select Press Service or Tunes to Exit</p>	

Price Menu

From the **Adjustment Menu**, select **Pricing** and enter. The Pricing Menu allows you to customize the pricing options and currency acceptor credit settings. Please note that if the acceptor is not present, the price setting will not have an effect on the game. Press Start to Select. Press Tunes or Service to Exit.

<p>Pricing Menu</p> <p>Money Unit Coin Value Coins Per Bill Pulse Coins Per Credit Credits to Start Credits to Continue</p> <p>Exit</p>	<p>Credit Options</p>
<p>Press Volume +/- or View 1/3 to Navigate Press Test or Start to Select Press Service or Tunes to Exit</p>	

Money Unit Menu

From the **Pricing Menu**, select **Money Unit** and enter. Select the currency which applies to the games location and press Start to Select. Press Tunes or Service to Exit.

<p>Select Currency</p> <p>USD US Dollars AUD AUS Dollars CAD CAN Dollars EUR Euros GBP British Pounds DEM Deutschmarks FRF French Franks JPY Japanese Yen ITL Italian Lire CHF Swiss Franks BRL Brazilian Reals DKK Danish Kroner MXN Mexican Pesos RUR Russian Rubles KRW Korean Won CNY Chinese Won</p> <p>Cancel</p>	<p>Credit Options</p>
<p>Press Volume +/- or View 1/3 to Navigate Press Test or Start to Select Press Service or Tunes to Exit</p>	

Coin Value Menu

From the **Pricing Menu**, select **Coin Value** and enter. Choose the coin value based on the currency selected and the coin acceptor type or setting. Press Start to Select. Press Tunes or Service to Exit.

Coin Value 0.01 USD 0.05 USD 0.10 USD 0.25 USD 0.50 USD 1.00 USD 2.00 USD 5.00 USD 10.00 USD 20.00 USD 50.00 USD 100.00 USD Exit	Credit Options
Press Volume +/- or View 1/3 to Navigate Press Test or Start to Select Press Service or Tunes to Exit	

Coin Per Bill Pulse Menu

From the **Pricing Menu**, select **Coin per Bill Pulse Menu** and enter. Choose the equivalent coin value based on the bill acceptor currency type or settings. Press Start to Select. Press Tunes or Service to Exit.

Coin Per Bill Pulse? 1 2 3 4 5 10 20 25 50 100 Exit	Credit Options
Press Volume +/- or View 1/3 to Navigate Press Test or Start to Select Press Service or Tunes to Exit	

Coin Per Credit Menu

From the **Pricing Menu**, select **Coin per Credit Menu** and enter. Choose the number of coins required to earn one credit. Press Start to Select. Press Tunes or Service to Exit.

<p>Coin Per Credit</p> <p>1 2 3 4 5 6 7 8 9 10</p> <p>Cancel</p>	<p>Credit Options</p>
<p>Press Volume +/- or View 1/3 to Navigate Press Test or Start to Select Press Service or Tunes to Exit</p>	

Credit To Start Menu

From the **Pricing Menu**, select **Credit To Start Menu** and enter. Choose the number of credits required to start one game. Press Start to Select. Press Tunes or Service to Exit.

<p>Credits to Start</p> <p>1 2 3 4 5 6 7 8 9 10</p> <p>Cancel</p>	<p>Credit Options</p>
<p>Press Volume +/- or View 1/3 to Navigate Press Test or Start to Select Press Service or Tunes to Exit</p>	

Coin Per Credit Menu

From the **Pricing Menu**, select **Credit To Continue Menu** and enter. Choose the number of credits required to continue from the current game. Press Start to Select. Press Tunes or Service to Exit.

Credits to Continue 1 2 3 4 5 6 7 8 9 10 Cancel	Credit Options
Press Volume +/- or View 1/3 to Navigate Press Test or Start to Select Press Service or Tunes to Exit	

Free Play Menu

From the **Adjustment Menu**, select **Free Play** and enter. Select whether the game should be in Free Play Mode. On this mode, a game may be started by simply pressing Start button. Press Start to Select. Press Tunes or Service to Exit.

Free Play Activate? Yes No Cancel	Preference and Adjustments
Press Volume +/- or View 1/3 to Navigate Press Test or Start to Select Press Service or Tunes to Exit	

1st Place Free Race Menu

From the **Adjustment Menu**, select **1st Place Free Race** and enter. The player wins a free race for a 1st place overall finish during a single of networked race game. Press Start to Select. Press Tunes or Service to Exit.

<p>First Place Wins Free Race?</p> <p>Yes No</p> <p>Cancel</p>	<p>Preference and Adjustments</p>
<p>Press Volume +/- or View 1/3 to Navigate Press Test or Start to Select Press Service or Tunes to Exit</p>	

Start Time Bonus Menu

From the **Adjustment Menu**, select **Start Time Bonus** and enter. Select the amount of time in seconds given to the player to reach the first check point. Press Start to Select. Press Tunes or Service to Exit.

<p>Start Bonus Time?</p> <p>30 seconds 40 seconds 50 seconds 60 seconds 70 seconds 80 seconds 90 seconds 100 seconds 110 seconds 120 seconds</p> <p>Cancel</p>	<p>Preference and Adjustments</p>
<p>Press Volume +/- or View 1/3 to Navigate Press Test or Start to Select Press Service or Tunes to Exit</p>	

Checkpoint Bonus Time Menu

From the **Adjustment Menu**, select **Checkpoint Bonus Time** and enter. Select the amount of time in seconds given to the player to reach the next check point after reaching a check point. Press Start to Select. Press Tunes or Service to Exit.

<p>Check Point Bonus Time?</p> <p>30 seconds 40 seconds 50 seconds 60 seconds 70 seconds 80 seconds 90 seconds 100 seconds</p> <p>Cancel</p>	<p>Preference and Adjustments</p>
<p>Press Volume +/- or View 1/3 to Navigate Press Test or Start to Select Press Service or Tunes to Exit</p>	

Attract Audio Menu

From the **Adjustment Menu**, select **Attract Audio** and enter. Select whether audio is active/ playing in attract mode. Press Start to Select. Press Tunes or Service to Exit

<p>Turn On Attract Mode Audio?</p> <p>Yes No</p> <p>Cancel</p>	<p>Preference and Adjustments</p>
<p>Press Volume +/- or View 1/3 to Navigate Press Test or Start to Select Press Service or Tunes to Exit</p>	

Game Difficulty Menu

From the **Adjustment Menu**, select **Game Difficulty** and enter. The default difficulty level is 5. Press Start to Select. Press Tunes or Service to Exit.

<p>Game Difficulty Level?</p> <p>1 Easier 2 3 4 5 6 7 8 9 10 Harder Cancel</p>	<p>Preference and Adjustments</p>
<p>Press Volume +/- or View 1/3 to Navigate Press Test or Start to Select Press Service or Tunes to Exit</p>	

Note:

Please reference the game Audit information to determine the appropriate difficulty setting for your location. Compare changes in game statistics and game revenue before and after the change.

Max Credits Menu

From the **Adjustment Menu**, select **Max Credits** and enter. Press Start to Select. Press Tunes or Service to Exit.

<p>Max Number Of Credits?</p> <p>10 15 20 25 30 35 40 45 50</p> <p>Cancel</p>	<p>Preference and Adjustments</p>
<p>Press Volume +/- or View 1/3 to Navigate Press Test or Start to Select Press Service or Tunes to Exit</p>	

Multiplay Win Gets Free Race Menu

From the **Adjustment Menu**, select **Multiplay Win Gets Free Race** and enter. Winner of a networked game wins a free race if active. Default setting is No. Press Start to Select. Press Tunes or Service to Exit.

<p>Multiplay 1st Wins Free Race?</p> <p>Yes No Cancel</p>	<p>Preference and Adjustments</p>
<p>Press Volume +/- or View 1/3 to Navigate Press Test or Start to Select Press Service or Tunes to Exit</p>	

Wheel Stiffness Level Menu

From the **Adjustment Menu**, select **Wheel Stiffness** and enter. Select wheel stiffness level. Default setting is 0.20. Press Start to Select. Press Tunes or Service to Exit.

<p>Wheel Stiffness Factor?</p> <p>0.00 Less Stiff 0.10 0.20 Default 0.30 0.40 More Stiff</p> <p>Cancel</p>	<p>Preference and Adjustments</p>
<p>Press Volume +/- or View 1/3 to Navigate Press Test or Start to Select Press Service or Tunes to Exit</p>	

Max Name Length Menu

From the **Adjustment Menu**, select **Max Name Length** and enter. This refers to the number of allowable characters when entering player names. Press Start to Select. Press Tunes or Service to Exit.

<p>Maximum Name Length?</p> <p>3 4 5 6 7</p> <p>Cancel</p>	<p>Preference and Adjustments</p>
<p>Press Volume +/- or View 1/3 to Navigate Press Test or Start to Select Press Service or Tunes to Exit</p>	

Exploding Cars Menu

From the ***Adjustment Menu***, select ***Exploding Cars*** and enter. Exploding cars apply only to Drone Cars during high speed collisions. Press Start to Select. Press Tunes or Service to Exit.

<p>Exploding Cars?</p> <p>Yes No</p> <p>Cancel</p>	<p>Preference and Adjustments</p>
<p>Press Volume +/- or View 1/3 to Navigate Press Test or Start to Select Press Service or Tunes to Exit</p>	

Plays for High Score Reset Menu

From the **Adjustment Menu**, select **Plays for High Score Reset** and enter. Select the number of plays before high score table is reset. Press Start to Select. Press Tunes or Service to Exit.

<p>Plays For High Score Reset?</p> <p>1000 2000 2500 5000 7500 10000 12500 15000 17500 20000</p> <p>Cancel</p>	<p>Preference and Adjustments</p>
<p>Press Volume +/- or View 1/3 to Navigate Press Test or Start to Select Press Service or Tunes to Exit</p>	

Utilities Menu

From the **Test Main Menu**, select **Utilities** and enter. The Utilities Menu contains tools which the operator could use to manage game adjustments or reset key game and player score and statistic information. The option to perform a game factory restore can also be accessed.

<p>Utilities Menu</p> <p>CRC Check</p> <p>Clear Credits Clear Audits Reset High Scores Reset Player Stats Default Adjustments Factory Restore</p> <p>Cancel</p>	<p>Utilities</p> <p>Please note the following:</p> <p>Setting default adjustments or performing a factory restore will require calibration afterwards.</p> <p>A factory restore will perform all the resets listed at the left, clearing credits, audits, high scores, player data.</p>
<p>Press Volume +/- or View 1/3 to Navigate Press Test or Start to Select Press Service or Tunes to Exit</p>	

Note:

- Information will be permanently erased by Clear or Reset functions.
- It is often ideal to perform a factory restore when the game is being moved to a new location.
- Record your game audit information if performing any of the above functions.

CRC Check Menu

From the **Utilities Menu**, select **CRC Check** and enter. Performing CRC check verifies the integrity of the software. Press Start to Select. Press Tunes or Service to Exit.

<p>Really Perform CRC Check?</p> <p>Yes No</p> <p>Cancel</p>	<p>Utilities</p> <p>Please note the following:</p> <p>Setting default adjustments or performing a factory restore will require calibration afterwards.</p> <p>A factory restore will perform all the resets listed at the left, clearing credits, audits, high scores, player data.</p>
<p>Press Volume +/- or View 1/3 to Navigate Press Test or Start to Select Press Service or Tunes to Exit</p>	

Clear Credit Menu

From the **Utilities Menu**, select **Clear Credits** and enter. Performing Clear Credit will delete any remaining credits posted. Press Start to Select. Press Tunes or Service to Exit.

<p>Really Clear Credits?</p> <p>Yes No</p> <p>Cancel</p>	<p>Utilities</p> <p>Please note the following:</p> <p>Setting default adjustments or performing a factory restore will require calibration afterwards.</p> <p>A factory restore will perform all the resets listed at the left, clearing credits, audits, high scores, player data.</p>
<p>Press Volume +/- or View 1/3 to Navigate Press Test or Start to Select Press Service or Tunes to Exit</p>	

Clear Audit Menu

From the **Utilities Menu**, select **Clear Audit** and enter. Performing Clear Audit will delete all audit information found on the Audit Menu. Please record them if you ever need to reference the information. Press Start to Select. Press Tunes or Service to Exit.

<p>Really Clear Credits?</p> <p>Yes No</p> <p>Cancel</p>	<p>Utilities</p> <p>Please note the following:</p> <p>Setting default adjustments or performing a factory restore will require calibration afterwards.</p> <p>A factory restore will perform all the resets listed at the left, clearing credits, audits, high scores, player data.</p>
<p>Press Volume +/- or View 1/3 to Navigate Press Test or Start to Select Press Service or Tunes to Exit</p>	

Clear High Scores Menu

From the **Utilities Menu**, select **Clear High Scores** and enter. Performing Clear High Score will clear the all high score tables. Press Start to Select. Press Tunes or Service to Exit.

<p>Really Clear High Scores?</p> <p>Yes No</p> <p>Cancel</p>	<p>Utilities</p> <p>Please note the following:</p> <p>Setting default adjustments or performing a factory restore will require calibration afterwards.</p> <p>A factory restore will perform all the resets listed at the left, clearing credits, audits, high scores, player data.</p>
<p>Press Volume +/- or View 1/3 to Navigate Press Test or Start to Select Press Service or Tunes to Exit</p>	

Clear Player Stats Menu

From the **Utilities Menu**, select **Clear Player Stats** and enter. Performing Clear Player Stats will clear all player information, including PIN, car upgrades and money earned. Press Start to Select. Press Tunes or Service to Exit.

<p>Really Clear Player Stats?</p> <p>Yes No</p> <p>Cancel</p>	<p>Utilities</p> <p>Please note the following:</p> <p>Setting default adjustments or performing a factory restore will require calibration afterwards.</p> <p>A factory restore will perform all the resets listed at the left, clearing credits, audits, high scores, player data.</p>
<p>Press Volume +/- or View 1/3 to Navigate Press Test or Start to Select Press Service or Tunes to Exit</p>	

Set Default Adjustments Menu

From the **Utilities Menu**, select **Default Adjustment** and enter. Performing Default Adjustment setting will restore game adjustments back to its manufacturer recommended settings. The game will need to be re-calibrated. Press Start to Select. Press Tunes or Service to Exit.

<p>Really Set Default Adjustments?</p> <p>Yes No</p> <p>Cancel</p>	<p>Utilities</p> <p>Please note the following:</p> <p>Setting default adjustments or performing a factory restore will require calibration afterwards.</p> <p>A factory restore will perform all the resets listed at the left, clearing credits, audits, high scores, player data.</p>
<p>Press Volume +/- or View 1/3 to Navigate Press Test or Start to Select Press Service or Tunes to Exit</p>	

Factory Restore Menu

From the **Utilities Menu**, select **Factory Restore** and enter. Performing Factory Restore will restore game adjustments back to its manufacturer recommended settings and clear all audit information. The game will need to be re-calibrated. Press Start to Select. Press Tunes or Service to Exit.

<p>Really Perform Factory Restore?</p> <p>Yes No</p> <p>Cancel</p>	<p>Utilities</p> <p>Please note the following:</p> <p>Setting default adjustments or performing a factory restore will require calibration afterwards.</p> <p>A factory restore will perform all the resets listed at the left, clearing credits, audits, high scores, player data.</p>
<p>Press Volume +/- or View 1/3 to Navigate Press Test or Start to Select Press Service or Tunes to Exit</p>	

Calibration Menu

From the **Test Main Menu**, select **Calibration** and enter. Making sure that the wheel, gas and brake are all properly calibrated is the easiest way to make sure that your driving game could maximize its earning potential. Follow the screen instructions carefully. Verify proper calibration on the Switch Test screen. Check and make sure that the minimum, center and maximum values correspond to the actual position of the control.

Calibration	
■	Turn Wheel To Center Hit Test/Start
■	Turn Wheel Left Then Hit Test/Start
■	Turn Wheel Right Then Hit Test/Start
■	Push and Release Gas Then Hit Test/Start
■	Push and Release Gas Then Hit Test/Start
□	Hit Test/Start to Exit

Note:
<ul style="list-style-type: none"> • If the game requires constant re-calibration, check the controls for mechanical wear or damage. Replace if necessary. • Normal wear and tear of the controls means that calibration should be part of the games scheduled maintenance.

Volume Menu

From the **Test Main Menu**, select **Volume** and enter. This refers to the game volume while in play. Use the Volume Up/ Volume Down button on the service panel to adjust volume level. Press Start to Select. Press Tunes or Service to Exit.

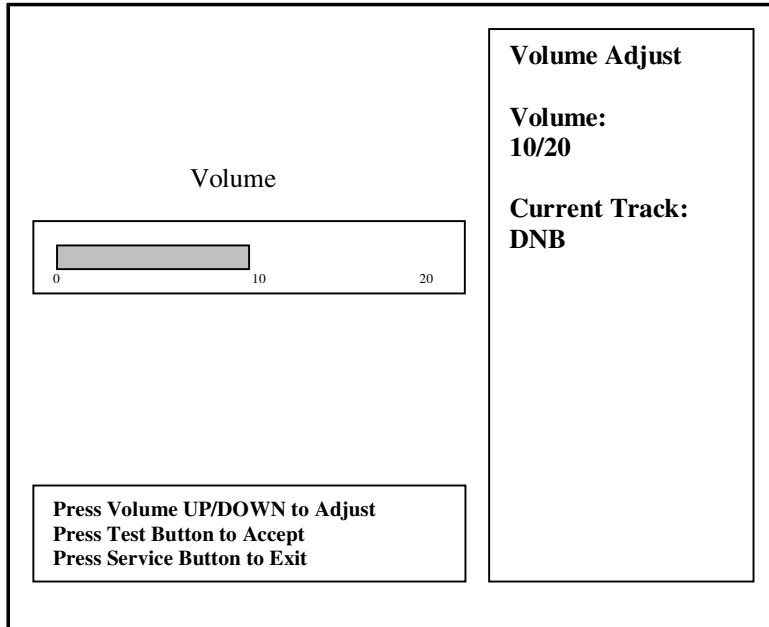

Note:

- Adjusting the volume while in attract mode only affects the attract volume and the not the actual game volume.
- Adjustment to game volume must be done while on Volume Adjust screen or while on game mode.
- Adjust volume levels relative to location and environment.

Volume Menu

From the **Test Main Menu**, select **Attract Volume** and enter. This refers to the attract mode volume. Use the Volume Up/ Volume Down button on the service panel to adjust volume level. Press Start to Select. Press Tunes or Service to Exit.

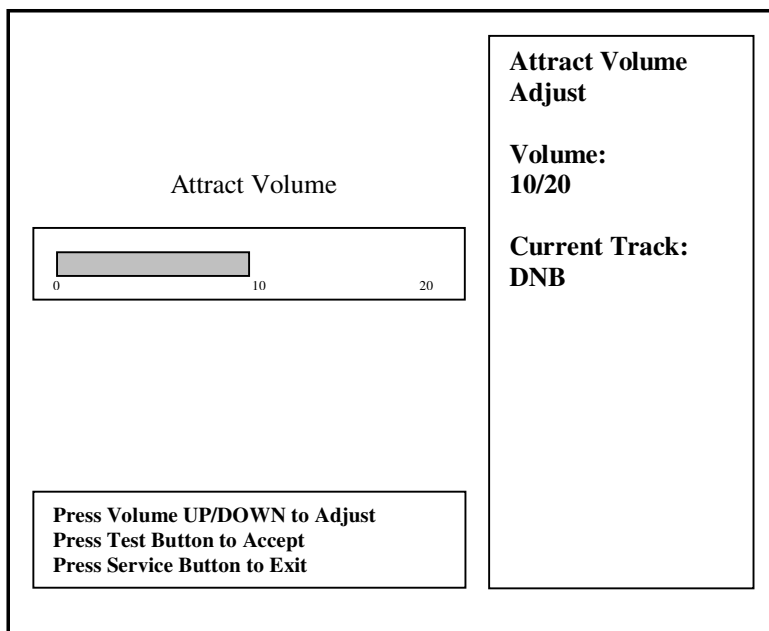

TROUBLESHOOTING GUIDE

PROBLEM	POSSIBLE CAUSE	SOLUTION
Game will not power up.	Game not plugged in.	Plug game into receptacle.
	Game not turned on.	Turn ON main power switch
	Game fuse is blown	Check game fuse.
	No power to receptacle.	Plug game into powered receptacle.

	PC power switch is OFF	Turn PC power switch ON.
	PC BIOS set wrong.	See Appendix B.
“No Signal” Message	Video cable not secure.	Check and secure video connector.
	PC not turned ON.	Turn ON power to PC.
No video display.	No power to video display.	Check power to video display.
		see <i>Game will not power up.</i>
No sound.	Audio cable not connected.	Check audio cable connection.
	Speaker not connected.	Check speaker connection.
“I/O Board Missing”	USB connector not connected.	Check USB connector from PC to I/O board. Perform Hard Drive Recovery
Game will not load.	New Hard Drive installed.	Power cycle by un-plugging game. Perform Hard Drive Recovery
	Hard Drive data corrupted.	Perform Hard Drive Recovery.
Game Freezes	Secure Dongle Loose	Secure and Tighten Dongle
	Poor Ventilation	Check Fan Operation and Airflow
	USB cable loose	Remove and Reinsert USB both ends of cable
	Failing or Bad Power Supply	Check Power Supply Output or Replace With Known Good.
	Corrupted Hard Drive	Perform CRC Check. Re-Image if bad.
Game resets.	Low DC voltage.	Check for proper voltage(+5V,+12V)
	Door lamp is wrong rating.	Use only 5volt lamps.
	Cabinet/PC temperature is too high.	Check that vents and fans are functioning and not obstructed.
	Hard Drive data corrupted.	Perform Hard Drive Recovery..
Not Linking	DIP Switch Set Wrong	Refer to Networking Setup Section.
	Network Cable Bad	Check Connection or Replace
	Game Operator Settings Not The Same.	Make Sure All Settings Are The Same Between Linked Games
No Wheel Feedback	Bad Wheel Driver Board	Replace With Known Good To Verify
	Bad Fuse on Wheel Driver Board	Replace Fuse On Wheel Driver With The Same Value Fuse
	Parallel Cable Loose	Secure and Tighten Parallel Cable
	Loose Electrical Connection	Check Connection To Motor and Wheel Driver Board
	Bad Transformer Fuse	Replace With Same Value Fuse

Warning: Do not connect or disconnect any cables or connectors on this game with the power on. This could potentially damage the game.

Appendix A: Hard Drive Recovery

NOTICE: Fast and the Furious is shipped with a recovery CD (Compact Disc). Hard drives have been known to occasionally fail for many reasons. Follow the procedure below to restore data on the hard drive if a disk failure should occur. Use extreme care when performing the following procedure and avoid rough handling of pc or CD. Please check the Troubleshooting Guide section of this document. Have the recovery CD ready before you begin.

The following are some symptoms which may indicate a possible bad hard drive:

- Hard Drive Test reports “bad” or “missing” files. Please refer to Trouble Shooting section of the manual.
- The game fails to finish loading.

- A boot error is reported after game is power cycled or reset.
- The game is looking for a boot CD to be inserted.
- Erratic game or attract mode.

Note: It is important that the USB cable from pc and power is connected to the I/O board before you proceed.

Hard Drive Recovery Procedure:

1. Open the control panel to access the pc.
2. Press the button on the CD drive to open CD tray.
3. Carefully insert the recovery disk into the tray.
4. Press the button on the CD drive to close the CD tray.
5. Turn OFF the pc by pressing the power button once.
6. Turn ON the pc by pressing the power button once.
7. Disk recovery process will begin automatically.
8. A message at the top of the screen will prompt you to remove the disk when process is over. Press the CD drive button to open tray. Remove the recovery disk and store safely.
9. Turn OFF the pc by pressing the power button once.
10. Turn ON the pc by pressing the power button once.

Note: Do not interrupt power or reset the game during the following process!

11. The game will begin to initialize and load. It will typically take about five minutes to complete.
12. The hard drive recovery process is complete when the game enters attract mode.
13. Proceed with control calibration and make necessary game adjustments. Please refer to Setup and Test section of this manual.

-- End of Procedure--

AppendixB: Power Management Setting(BIOS)

NOTE: Fast and Furious is shipped with the correct BIOS settings. Any changes made to the BIOS other than what is described below may adversely affect game functionality.

This BIOS setting allows the PC to automatically power up when AC power is detected. This eliminates the need to manually turn the PC ON after a power disruption.

Procedure:

1. Turn game *OFF*.
2. Connect a PS/2 or USB keyboard to the PC.
3. Hold the DELETE key while turning the PC *ON*.
4. On the **BIOS** menu screen, use the DOWN arrow to scroll down to **Power Management Setup**. Hit ENTER key once.

5. On the **Power Management Setup** menu, use the DOWN arrow to scroll down to **After AC Power Lost**.
6. Use the (+) button to change **After Power Lost** setting to: [**Power ON**].
7. Hit F10.
8. Hit Enter to Save and Exit.
9. PC will reset and begin to load game.

Appendix C: Basic Display Adjustments

WARNING: Extremely high voltage is present on the monitor assembly. The monitor does not contain any user serviceable parts. Do not attempt to service the monitor.

Target: Terror utilizes gun optic boards which rely on signals being detected from the display to operate properly. The quality of the display is an important element in making sure that the guns operate correctly and reliably.

The following are display settings which you should become familiar with. It is important to note that settings may differ slightly between manufacturers and even between displays of the same manufacturers. Certain factors like age of the display could also be a factor. Therefore, the information below should only serve as a reference as actual settings may not be practical in most cases.

Setting	Adjustment
Brightness	Function: Background Brightness or Black Level. Set Level: Black background should appear dark and not gray.
Contrast	Function: Definition/ Sharpness of character against background. Set Level: Outer edges of character or text should not be distorted.
H-Position	Function: Horizontal Position. Side/side centering.

	Set Level: Picture should be centered from side to side.
H-Size	Function: Horizontal Size. Side/side dimension. Set Level: Picture should be full from side to side.
V-Position	Function: Vertical Position. Up/down centering. Set Level: Picture should be centered up and down.
V-Size	Function: Vertical Size. Up/down dimension. Set Level: Picture should be full from top to bottom.
Pin Cushion	Function: Degree of straightness along both vertical sides of the picture. Set Level: Both sides of the picture should be straight, without curvature.
Degauss	Function: De-magnetizes the picture tube when activated. This eliminates picture discoloration caused by magnetic disturbance around the picture tube.

Digital displays are adjusted using a button type remote adjust board. Below are functional diagrams for Kortek and Wells Gardner 27" digital displays:

Kortek Remote:

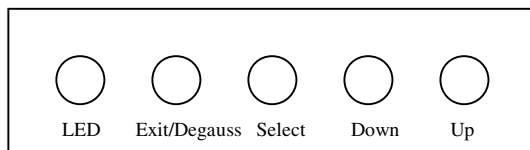

Exit/Degauss: Exit Menu or Degauss
Select: Select setting to be adjusted.
Down: Cycles downward thru levels
Up: Cycles upward thru levels

Wells Gardner:

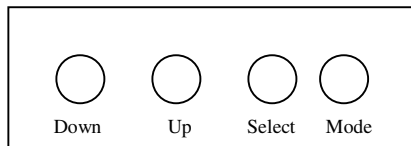

Down: Cycles downward thru levels
Up: Cycles upward thru levels
Select: Select setting to be adjusted.
Mode: Menu/Exit

THE FAST AND THE FURIOUS PARTS LIST

RT PART # Description

Part # Code: Game - Type - Assembly - Subassy - Subassy - Number

2-1-00-00-00-000	27" SITDOWN FAST AND FURIOUS GAME
2-1-01-00-00-000	27" SITDOWN CABINET ASSEMBLY
2-1-01-00-00-001	27" Sitdown Cabinet
2-1-01-00-00-002	27" Sitdown Marquee Graphics
2-1-01-00-00-003	27" Sitdown Left Side Cabinet Sticker
2-1-01-00-00-004	27" Sitdown Right Side Cabinet Sticker
2-1-01-00-00-005	27" Sitdown Instrument Panel Sticker
2-1-01-00-00-006	27" Sitdown Shift Panel Sticker
2-1-01-00-00-007	27" Sitdown Speaker Panel Top Sticker
2-1-01-00-00-008	27" Sitdown Speaker Panel Low Sticker
2-1-01-00-00-009	27" Sitdown Left Side Pedestal Sticker
2-1-01-00-00-010	27" Sitdown Right Side Pedestal Sticker
2-1-01-00-00-011	27" Sitdown Seat Back Sticker
2-1-01-00-00-012	27" Sitdown Marquee Clear Plastic Lens
2-1-01-00-00-013	27" Sitdown Instruction Panel Clear Overlay
2-1-01-00-00-014	27" Sitdown Shift Panel Clear Overlay
2-1-01-00-00-015	27" Sitdown Ped Cent Back Sticker
2-1-01-00-00-016	27" Sitdown Ped Low Back Sticker
2-1-01-00-00-017	DECAL WHEEL CAP FF LOGO
2-1-01-00-00-018	BEZEL
2-1-01-00-00-019	DASHBOARD COVER
2-1-01-00-00-020	PEDESTAL UPPER LIGHT WINDOW
2-1-01-00-00-021	PEDESTAL LOWER LIGHT WINDOW
2-1-02-00-00-000	COMPUTER- FNF MICROTEL
2-1-02-00-00-001	MOTHER BOARD,MSI
2-1-02-00-00-002	512 RAM PC3200
2-1-02-00-00-003	20G HD 7200 RPM
2-1-02-00-00-004	AMD ATHLON PROC.
2-1-02-00-00-005	NVIDIA GRAPHICS
2-1-02-00-00-006	PC uATX 270W PowerSupply
2-1-02-00-00-007	INTERNAL WATCHDOG HARNESS
2-1-02-00-00-008	WATCHDOG HARNESS BRACKET
2-1-02-00-00-009	DONGLE
2-1-02-00-00-010	WIN XP LICENSE STICKER
2-1-02-00-00-011	STEREO 1/8" CABLE
2-1-02-00-00-012	AV CABLE- PLUG TO PLUG
2-1-02-00-00-013	MOLDED DB25- THROUGH
2-1-02-00-00-014	CROSSOVER NETWORK CABLE 10"
2-1-02-00-00-015	USB CABLE- 6' MALE/MALE
2-1-02-00-00-016	TRANSFORMER MCI 4-06-8036G
2-1-02-00-00-017	POWER SUPPLY PETER CHO,200W
2-1-02-00-00-018	RUBBER SANDWICH MOUNT

2-1-03-00-00-000 STEERING WHEEL ASSY.
 2-1-03-00-00-001 STEERING WHEEL HOOP- SOFT RUBBER
 2-1-03-00-00-002 36V STEERING MECH
 2-1-03-00-00-003 WHEEL CAP FOR SOFT HOOP W/FF LOGO
 2-1-03-00-00-004 SPLIT HUB F 5/8" SHAFT

2-1-04-00-00-000 MONITOR 27" KORTEK

2-1-05-00-00-000 MANUAL
 2-1-05-00-00-001 INSPECTION SHEET
 2-1-05-00-00-002 QC AUDIT SHEET
 2-1-05-00-00-003 HD RECOVERY CD

2-1-06-00-00-000 DUAL PEDAL MECH W/ LONG LIFE POT

2-1-07-00-00-000 SPIRAL 26WATT LAMP MED BASE SCREW IN

2-1-08-00-00-000 FLOURECENT LAMP ASSY 24--ST120x40 AMER. FLOUR

2-1-09-00-00-000 SEAT ASSY
 2-1-09-00-00-001 SEAT SLIDE ASSY W/NEW BASEPLATE
 2-1-09-00-00-002 GRILL ASSY MOLDED(HEADREST)
 2-1-09-00-00-003 SEAT - NO TRIM FOR HEAD SPKR

2-1-10-00-00-000 SPEAKER MARQUEE- 8OHM SHEILDED 5.5" FULL RANGE

2-1-11-00-00-000 SPEAKER WOOFER- 6.5" 4 OHM

2-1-12-00-00-000 I/O BOARD

2-1-13-00-00-000 H-BOOM BOARD

2-1-13-00-00-000 BUTTON LARGE ELLIP ORANGE-TUNES
 2-1-13-00-00-001 BUTTON LARGE ELLIP GRN-START/NITRO
 2-1-13-00-00-002 BUTTON LARGE ELLIP RED-1
 2-1-13-00-00-003 BUTTON LARGE ELLIP WHIT 2
 2-1-13-00-00-004 BUTTON LARGE ELLIP BLUE 3
 2-1-13-00-00-005 SERVICE SWITCH(BLACK OR RED) .5A

2-1-14-00-00-000 KEYPAD

2-1-15-00-00-000 SHIFTER 4WAY ASSY
 2-1-15-00-00-001 SHIFTER MOUNTING PLATE
 2-1-15-00-00-002 SHIFTER 4WAY

2-1-16-00-00-00	S/A WELDMENT CONTROL PANEL
2-1-16-00-00-01	WELDMENT COIN VAULT
2-1-16-00-00-02	VENT LOUVER, 8 HOLE
2-1-16-00-00-03	MARQUEE SPEAKER GRILL POWDER COAT
2-1-16-00-00-04	TEST SERVICE BRACKET
2-1-16-00-00-05	PEDESTAL SUPPORT BEAM
2-1-16-00-00-06	BRACKET CPU MOUNT
2-1-16-00-00-07	BRACKET MONITOR MOUNTING
2-1-16-00-00-08	ANGLE MONITOR BRACKET EDGE BLK
2-1-16-00-00-09	ANGLE PEDESTAL EDGE BLK
2-1-16-00-00-10	SEAT SPEAKER GRILL BLK
2-1-16-00-00-11	MONITOR BARRIER SIDE/SIDE
2-1-16-00-00-12	MONITOR BARRIER TOP/BTM
2-1-16-00-00-13	WOOD PC MOUNT
2-1-17-00-00-00	Kortek2914f remote ext.cbl

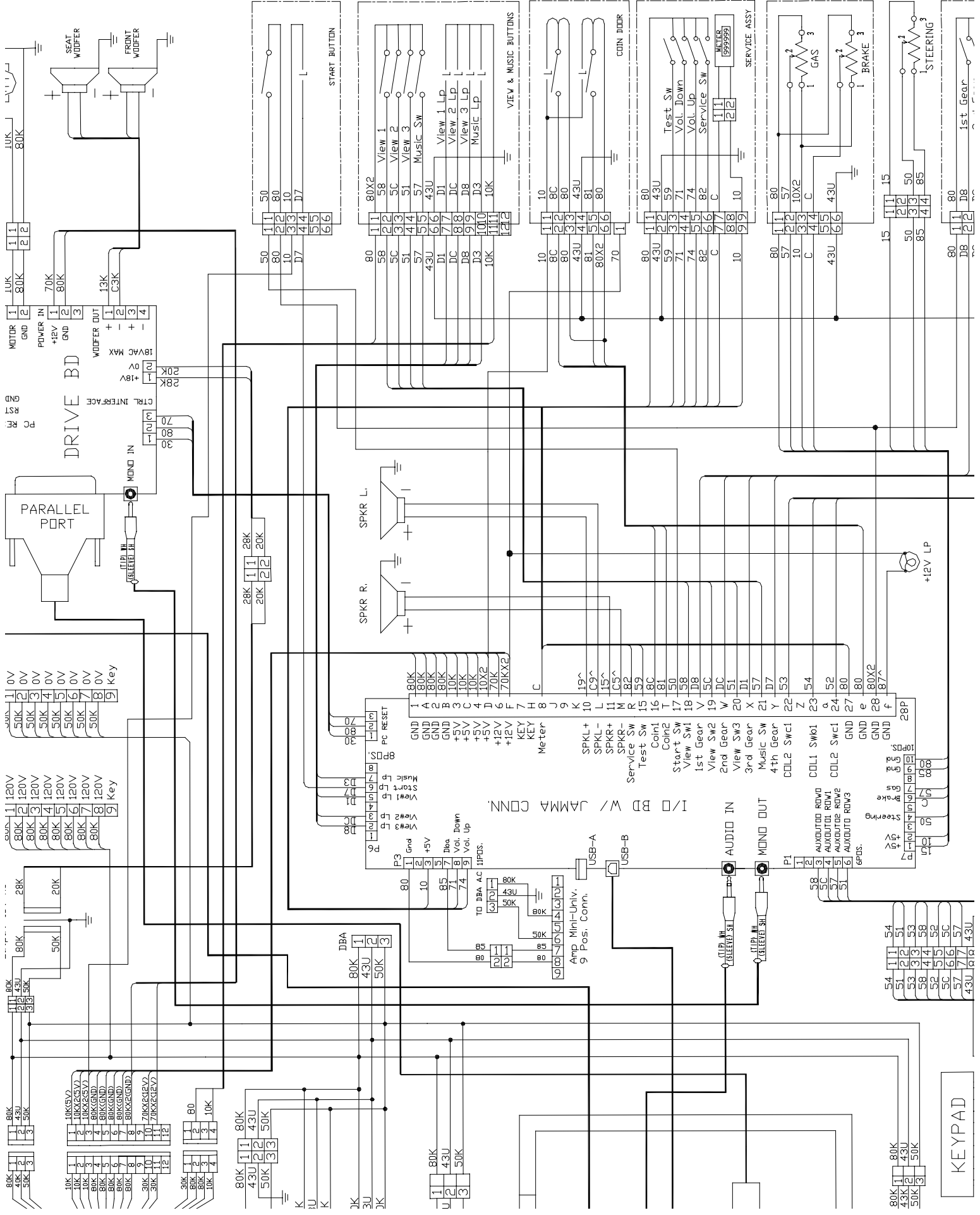

KEYPAD

1st Gear

STEERING

BRAKE

GAS

METER (595959)

COIN DOOR

VIEW & MUSIC BUTTONS

START BUTTON

FRONT W/OFER

SEAT W/OFER

Copyright and License Notice:

The Fast and the Furious videogame Copyright 2004 Raw Thrills, Inc. All rights reserved.

The Fast and the Furious is a trademark and copyright of Universal Studios licensed by Universal Studios Licensing L.L.L.P. All rights reserved. Parental Advisory: A note to parents: The Fast and the Furious is rated PG-13. Consult www.filmratings.com for further information.

Steering wheel force feedback technology licensed from Atari Games Corporation, United States patent #5,044,956.

Official Nissan Product. Nissan, 350Z, 240SX, Skyline GTR and associated symbols, emblems and designs are trademarks of Nissan Motor Co., Ltd. Used under license to Raw Thrills, Inc.

Toyota, Supra, Celica, MR2 and all other associated marks, emblems and designs are intellectual property rights of Toyota Motor Corporation and used with permission.

Mitsubishi, Eclipse, Lancer EVO VIII, emblems, and distinctive vehicle body designs are trademarks of Mitsubishi Motors Corporation and are used under license to Raw Thrills, Inc.

Dodge is a trademark of DaimlerChrysler Corporation. Hemi(r) is a registered trademark of DaimlerChrysler Corporation. Dodge Charger, Dodge Challenger, Dodge HEMI(r), Dodge Viper and their trade dress are used under license by (Licensee). (c) DaimlerChrysler Corporation 2005.

General Motors Trademarks used under license to Raw Thrills.

Hummer, Hummer H2, all related emblems and the distinctive vehicle body and grille design are General Motors Trademarks used under license to Raw Thrills.