

- NOTES
- ⊗ : ELECTROLYTIC CONDENSER
  - ⊙ : CERAMIC CONDENSER
  - : FLAT CABLE CONNECTOR 40P
  - : 5V CONNECTOR 2P
  - JP1: 2764
  - JP2: 27128
  - JP4:

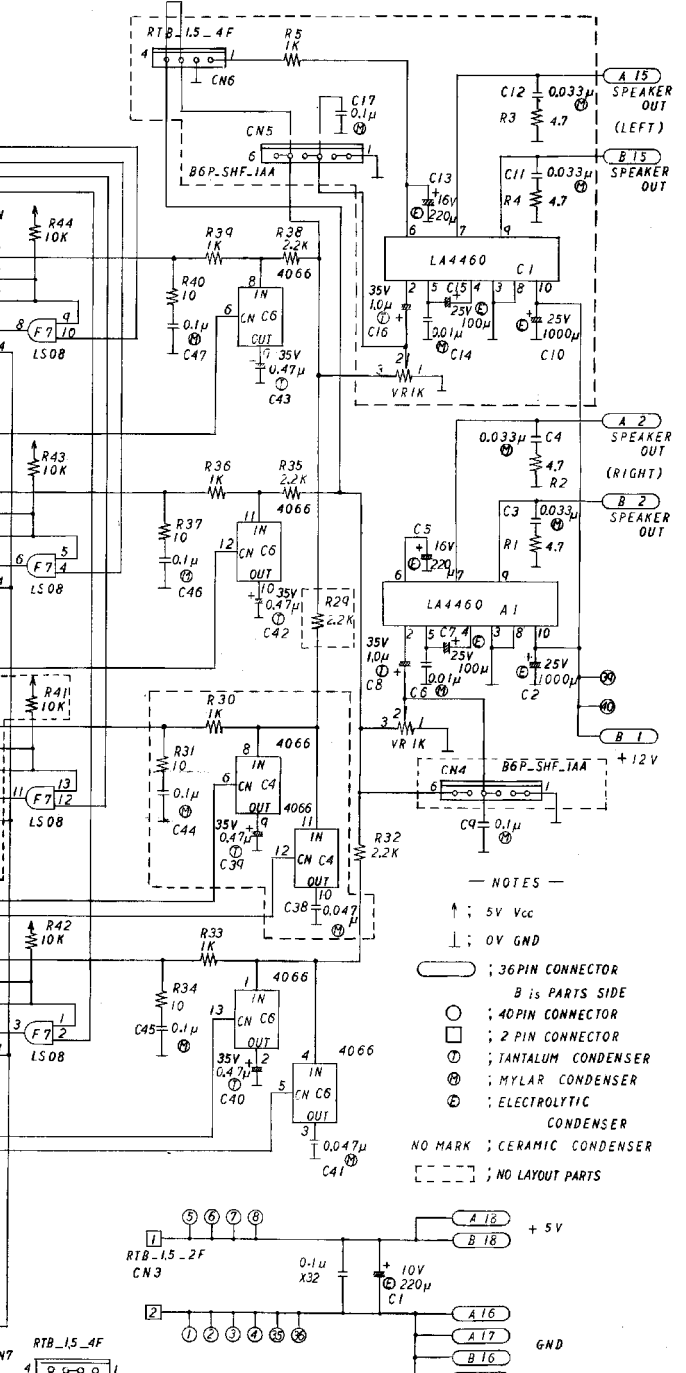

PWB(A)2000 112D CRT BOARD

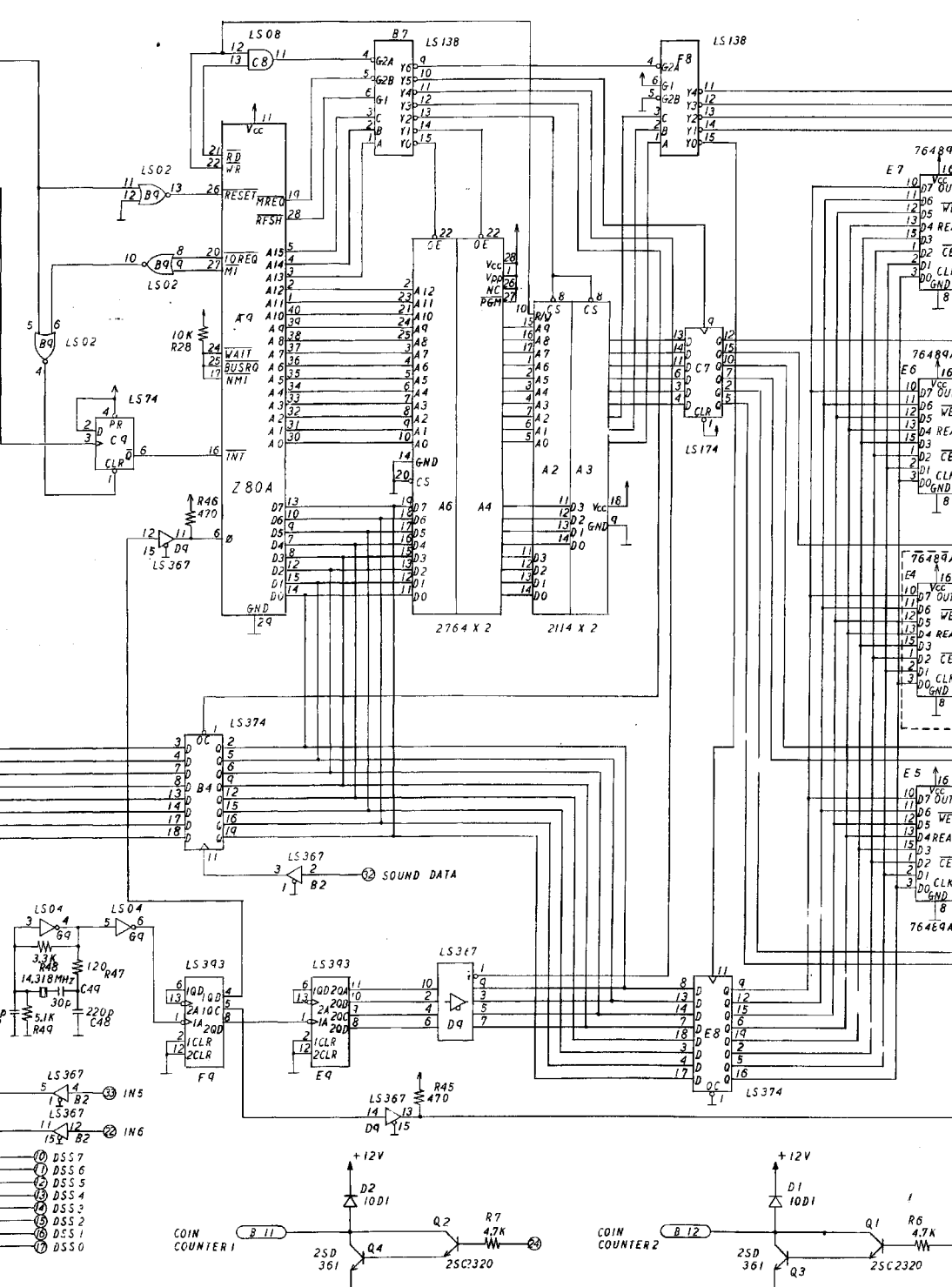
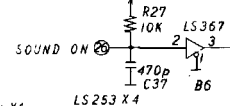
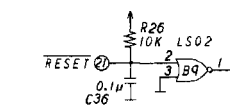
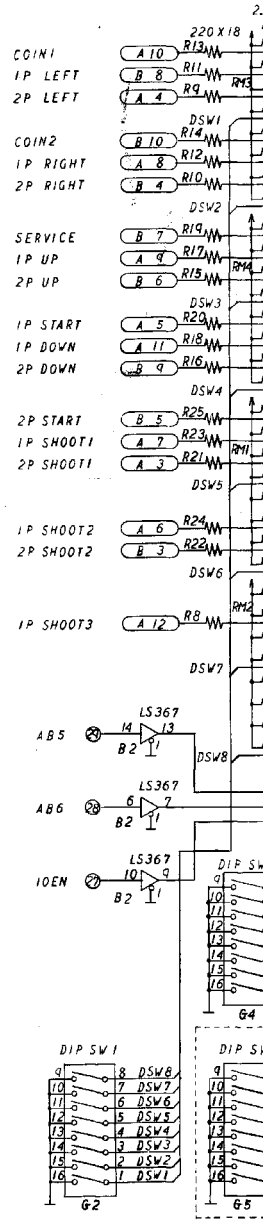
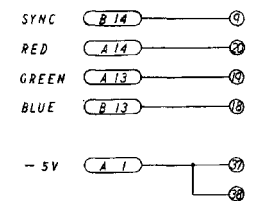

- NOTES
- ↑ : 5V Vcc
  - ↓ : 0V GND
  - : 36PIN CONNECTOR
  - : B is PARTS SIDE
  - : 40PIN CONNECTOR
  - : 2 PIN CONNECTOR
  - : TANTALUM CONDENSER
  - ⊗ : MYLAR CONDENSER
  - ⊙ : ELECTROLYTIC CONDENSER
  - NO MARK : CERAMIC CONDENSER
  - : NO LAYOUT PARTS

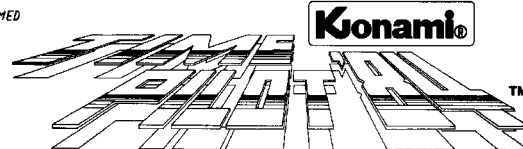
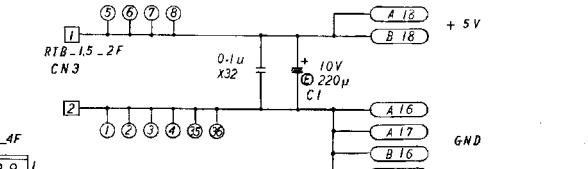
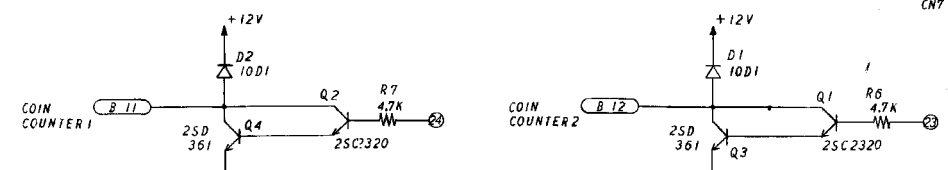

PWB(B)3000 157B SOUND BOARD