

SEGA®

Out Run

UPRIGHT TYPE

OWNER'S MANUAL



SEGA ENTERPRISES, LTD.

TABLE OF CONTENTS

| | |
|--|-------|
| INTRODUCTION OF THE OWNER'S MANUAL | 2 |
| 1. HANDLING PRECAUTIONS | 2 |
| 2. PREVENTION OF COUNTERFEITING AND CONVERSION | 3 |
| 3. PRECAUTIONS CONCERNING THE PLACE OF INSTALLATION | 4 |
| 4. NAME OF PARTS | 5 |
| 5. SERVICING THE HANDLE UNIT AND WINDOW MASK | 6 |
| 6. DISASSEMBLING AND ADJUSTING THE HANDLE UNIT | 7~8 |
| 7. DISASSEMBLING AND ADJUSTING THE ACCELERATOR AND BRAKE | 9 |
| 8. ADJUSTING THE ACCELERATOR/BRAKE POTENTIOMETER | 10 |
| 9. ADJUSTMENT OF THE SERVICE SWITCH | 11 |
| 10. INSTRUCTION OF BOARD AND CONNECTORS | 12 |
| 11. DIP SWITCH SETTING | 13 |
| 12. EPROM/ROM LOCATIONS | 14~15 |
| 13. SELF-TESTING | 16~22 |
| 14. PARTS LIST | 23~39 |
| 15. WIRING DIAGRAM | 40 |

UPRIGHT TYPE

SPECIFICATIONS

| | |
|--------------------|---|
| INSTALLATION SPACE | : 630 mm (25 in.) W × 970 mm (38 in.) D |
| HEIGHT | : 1815 mm (71.5 in.) |
| POWER | : 250 W |
| C. R. T. | : 20" |
| WEIGHT | : 110 kg (242.5 lbs) |

NOTE

- o Descriptions herein contained may be subject to improvement changes without notice.

INTRODUCTION OF THE OWNER'S MANUAL

SEGA ENTERPRISES, LTD., supported by its high electronic technology of LSIs, microprocessors, etc. and a wealth of experience, has for more than 30 years been supplying various innovative and popular game machines to the world market. This OWNER'S manual is intended to provide detailed comments together with all the necessary information covering the operation in general of electronic assemblies, electromechanicals, servicing control, spare parts, etc. as regards the OUT RUN, a new SEGA product. The manual is intended for those who have knowledge of electricity and technical expertise especially in ICs, CRTs, microprocessors, etc. Carefully read so as to acquire sufficient knowledge before working on the machine. Should there be a malfunction, non-technical personnel should under no circumstance touch the interior system.

1. HANDLING PRECAUTIONS

When installing or inspecting, be very careful of the following points and pay attention to ensure that the player can enjoy the game safely.

- o Be sure to turn the power off before working on the machine.
- o To insert or pull out the plug quickly is dangerous.
- o It is necessary to make sure that the power cord or the grounding wire is not exposed on the road, etc. in a manner so as to be dangerous. Make sure that grounding connections are made safely at the position where so specified.
- o Do not use any fuse that does not meet the specified rating.
- o Make complete connections for the IC board and other connectors. Insufficient insertion is very dangerous.

Also, for the IC board circuit inspections, only the logic tone is allowed. The use of a tester is not permitted, so be careful in this regard. After confirming that there are no irregularities, turn the power ON.

2. PREVENTION OF COUNTERFEITING AND CONVERSION

LABELLING

To prevent counterfeits and conversions, the following labels are put on all the SEGA products. When handling such goods, be sure to confirm the labels. They are used to prevent illegal acts such as the unauthorized copying of the products and the printed circuit boards thereof or carrying on business by manufacturing similar merchandise or by converting, selling or using such products or printed circuit boards.

ORIGINAL SEAL

The following seal is put on the machines manufactured by SEGA.



LICENSE SEAL

The following seal is put on the kits, such as the printed circuit boards, of SEGA products.

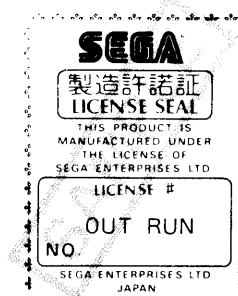

COPYRIGHT NOTICE

This SEGA product has the copyright notice as follows:

© SEGA 1986

This signifies that this work was disclosed in 1986 and is the property of SEGA ENTERPRISES, LTD.

3. PRECAUTIONS CONCERNING THE PLACE OF INSTALLATION

The OUT RUN is an indoor game machine. Absolutely do not install it outside. Even indoors, avoid installing in places mentioned below so as to ensure proper usage:

- o Places subject to rain or water leakage, or condensation due to humidity.
- o In the proximity of an indoor swimming pool and/or shower.
- o Places subject to direct sunlight.
- o Places subject to heat sources from heating units, etc., or hot air.
- o Vicinity of highly inflammable/volatile chemicals or hazardous matter.
- o Sloped surfaces.
- o Vicinity of anti-disaster facilities such as fire exits and fire extinguishers.
- o Places subject to any type of violent impact.
- o Dusty places.

4. NAME OF PARTS

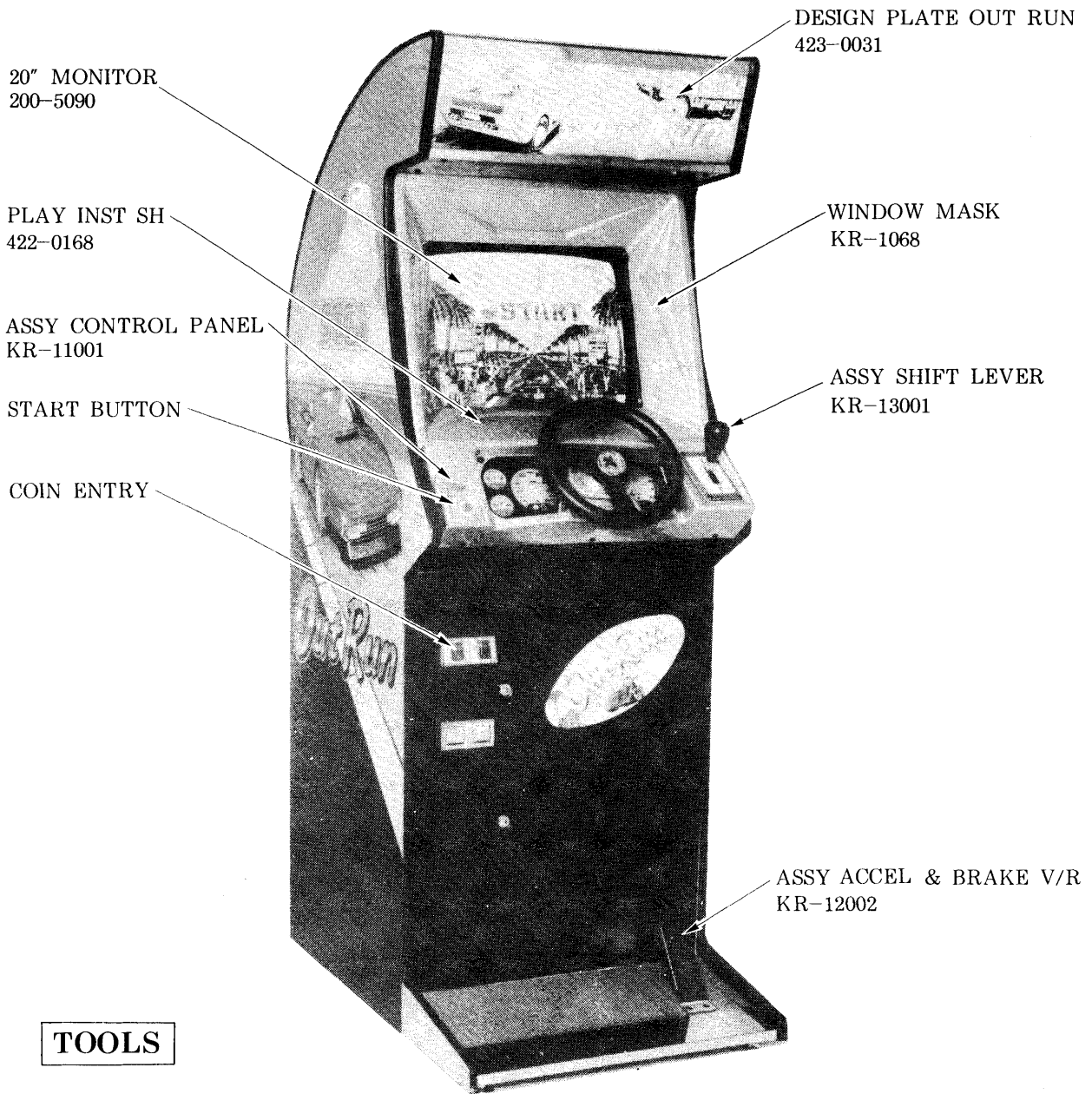

TOOLS

(TAMPERPROOF WRENCH)

(TAMPERPROOF WRENCH)

- M4 540-0006-01
- M5 540-0007-01
- M6 540-0015-01
- M8 540-0009-01

- M4 540-0018
- M5 540-0017

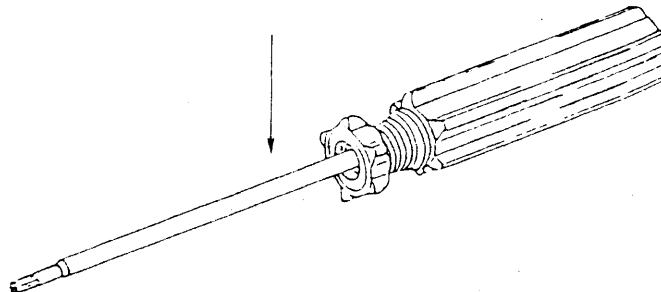
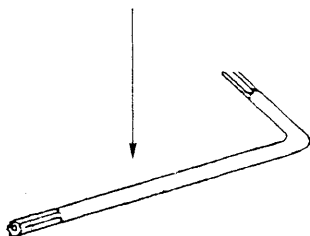

5. SERVICING THE HANDLE UNIT AND WINDOW MASK



- ① The HANDLE UNIT can be opened towards you by taking off the 3 TAMPERPROOF screws.
- ② To remove the WINDOW MASK from the cabinet, take off the TAMPERPROOF screws (M4x8) inside the WINDOW MASK.
- ③ Next open it towards you.

This allows for the clearing of the monitor screen (CRT surfaces).

6. DISASSEMBLING AND ADJUSTING THE HANDLE UNIT

To open the dashboard, take off the 2 M8 TAMPERPROOF screws.

After doing this, spring replacements and steering adjustments can be made.

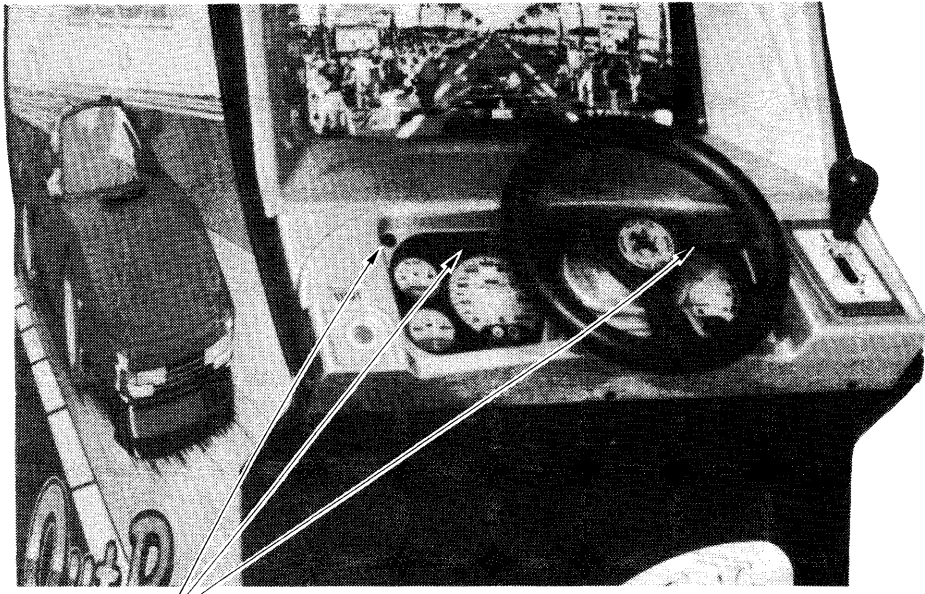

TAMPERPROOF SCREW M8

- ① Release the 2 adjusting screws of the potentiometer bracket and perform the necessary adjustments by changing its gear position, making sure that the variable is within the allowable extent as shown below, and then retighten the adjusting screw.

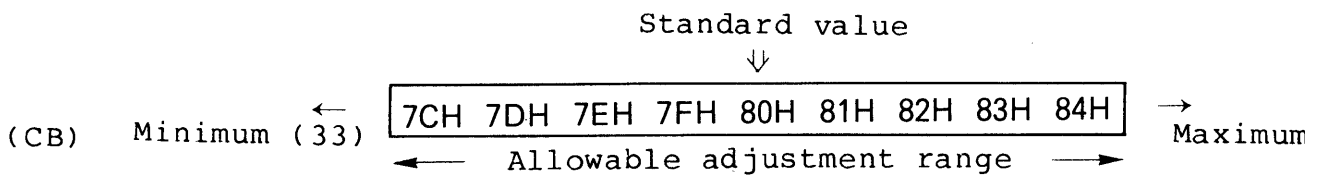
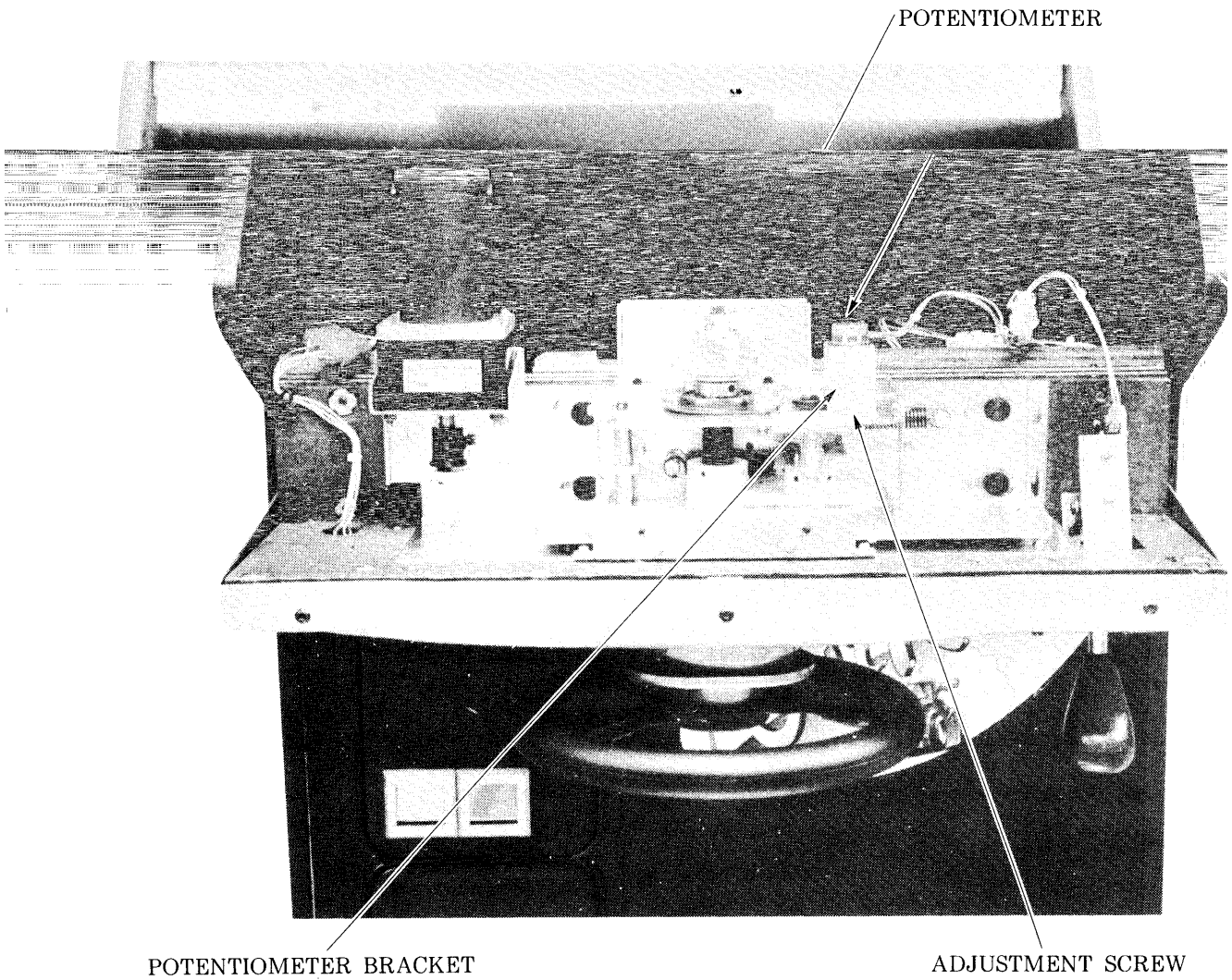

7. DISASSEMBLING AND ADJUSTING THE ACCELERATOR AND BRAKE

To remove the accelerator/brake unit, take off the 7 M5 TAMPERPROOF SCREWS.

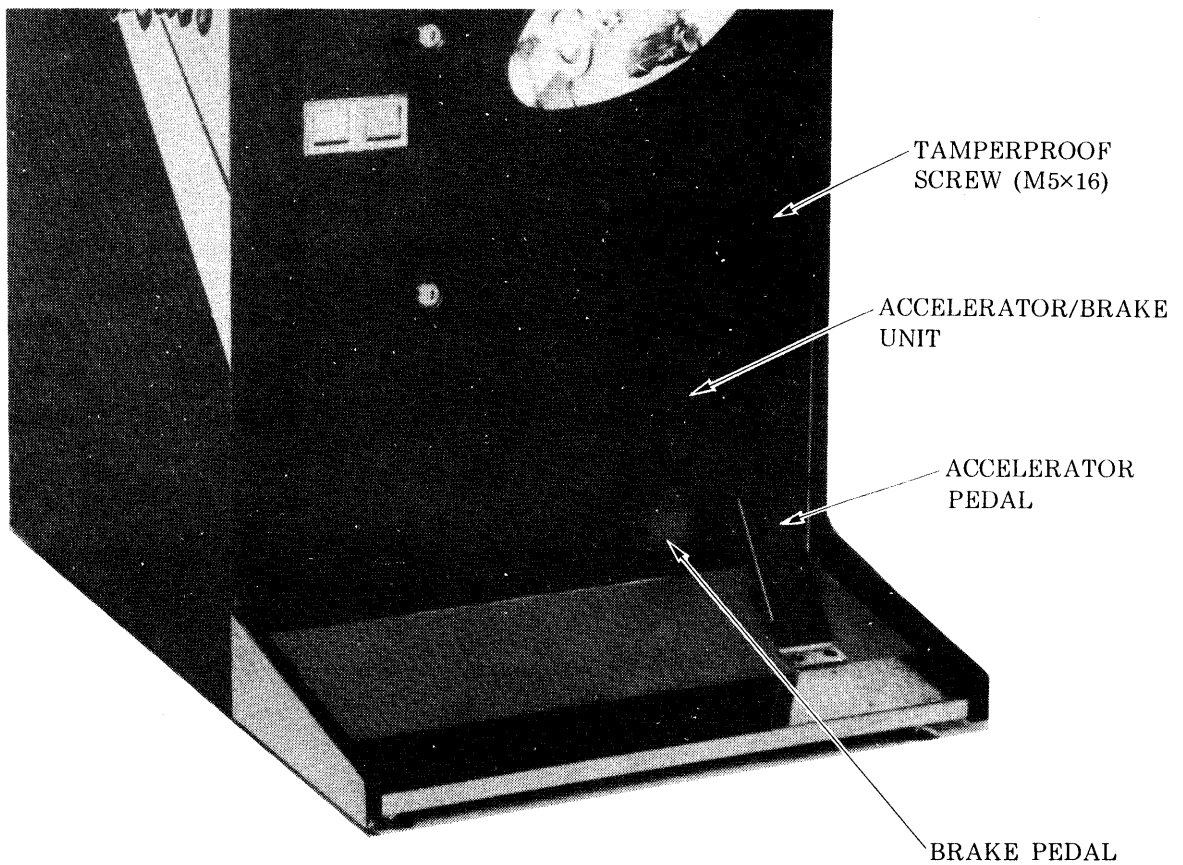

8. ADJUSTING THE ACCELERATOR/BRAKE POTENTIOMETER

- ① Display the SELF-TESTING MODE screen shown on page 16.
- ② Release the adjustment screws, move the bracket, and make adjustments so that the variable becomes 20H when the accelerator/brake is released and returns to its original position.
- ③ Even after the above procedure has been followed, if the variable is not within the allowable range, then slightly turn the gear to make an adjustment.

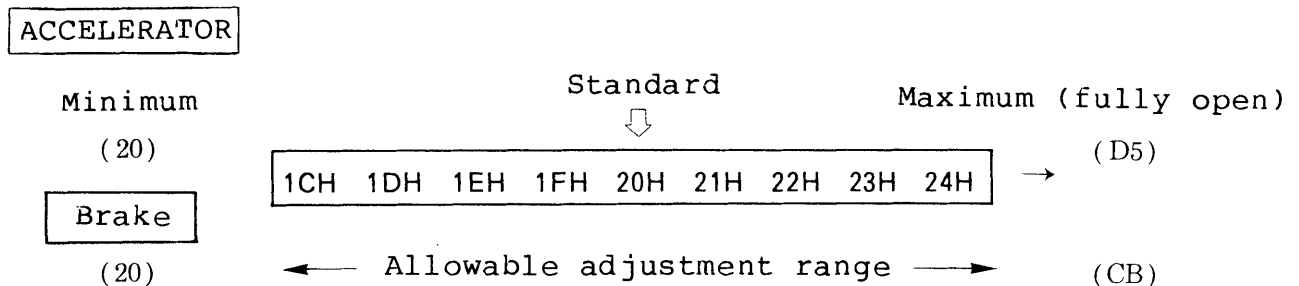
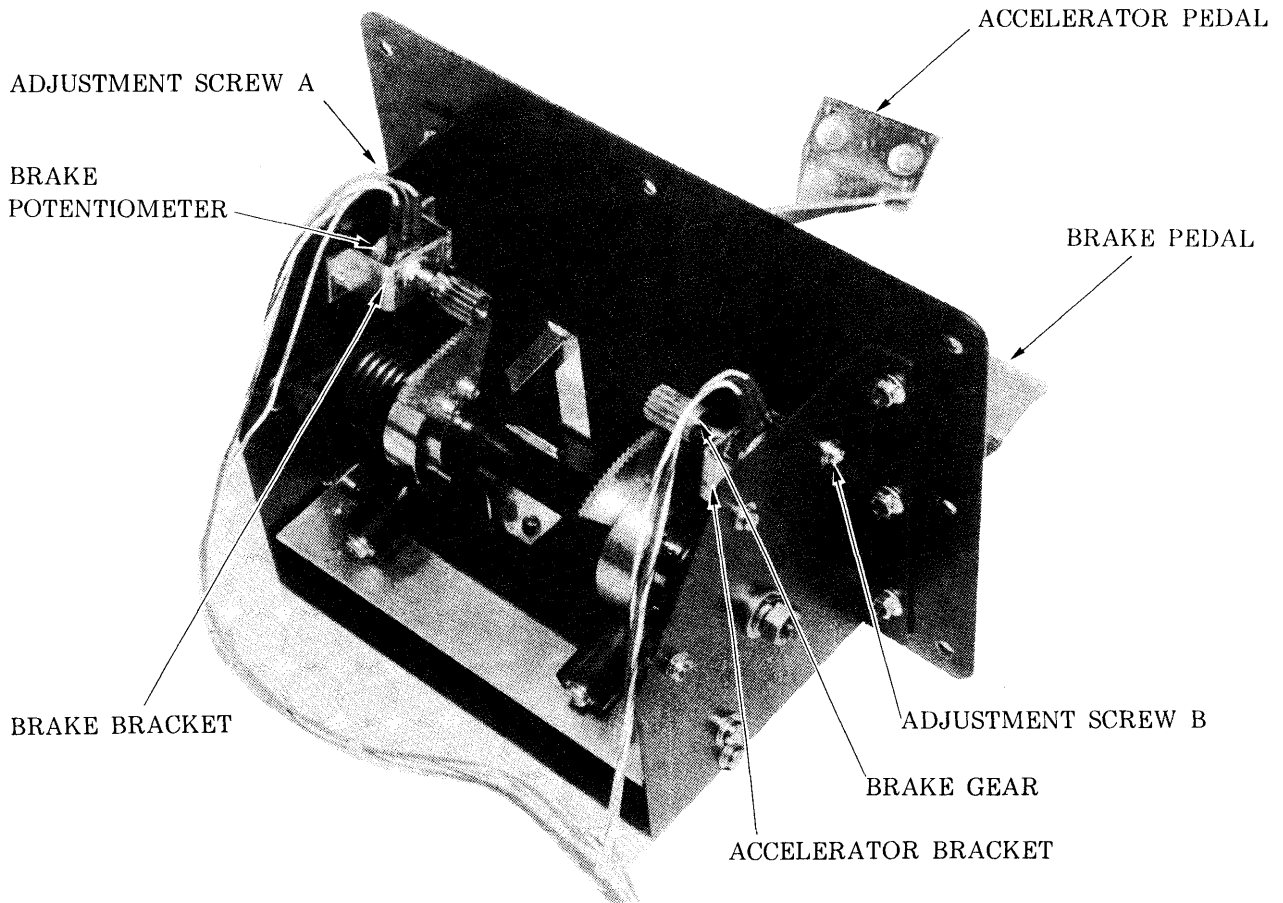

9. ADJUSTMENT OF THE SERVICE SWITCH

The layout as shown below can be viewed by opening the coin chute door.

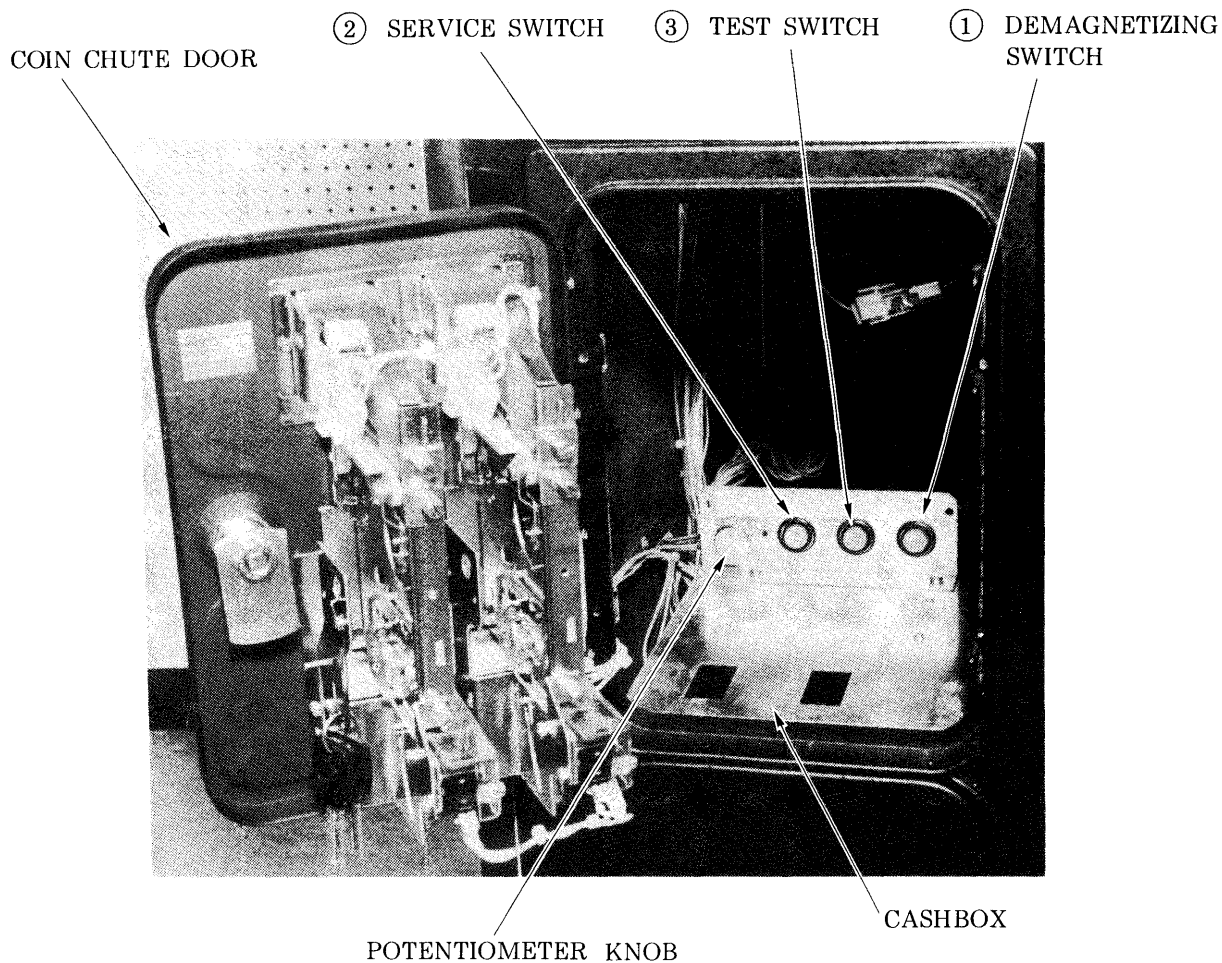

OPERATING INSTRUCTIONS

- ① DEMAGNETIZING SWITCH.....Used for removing the on-screen color unevenness.
- ② SERVICE SWITCH.....Used for the purpose of servicing and increasing the credits without registering on the meter (this allows you to check the game).
- ③ TEST SWITCH.....For operating this switch, see SELF-TESTING.
- ④ POTENTIOMETER ADJUSTMENT

10. INSTRUCTION OF BOARD AND CONNECTORS

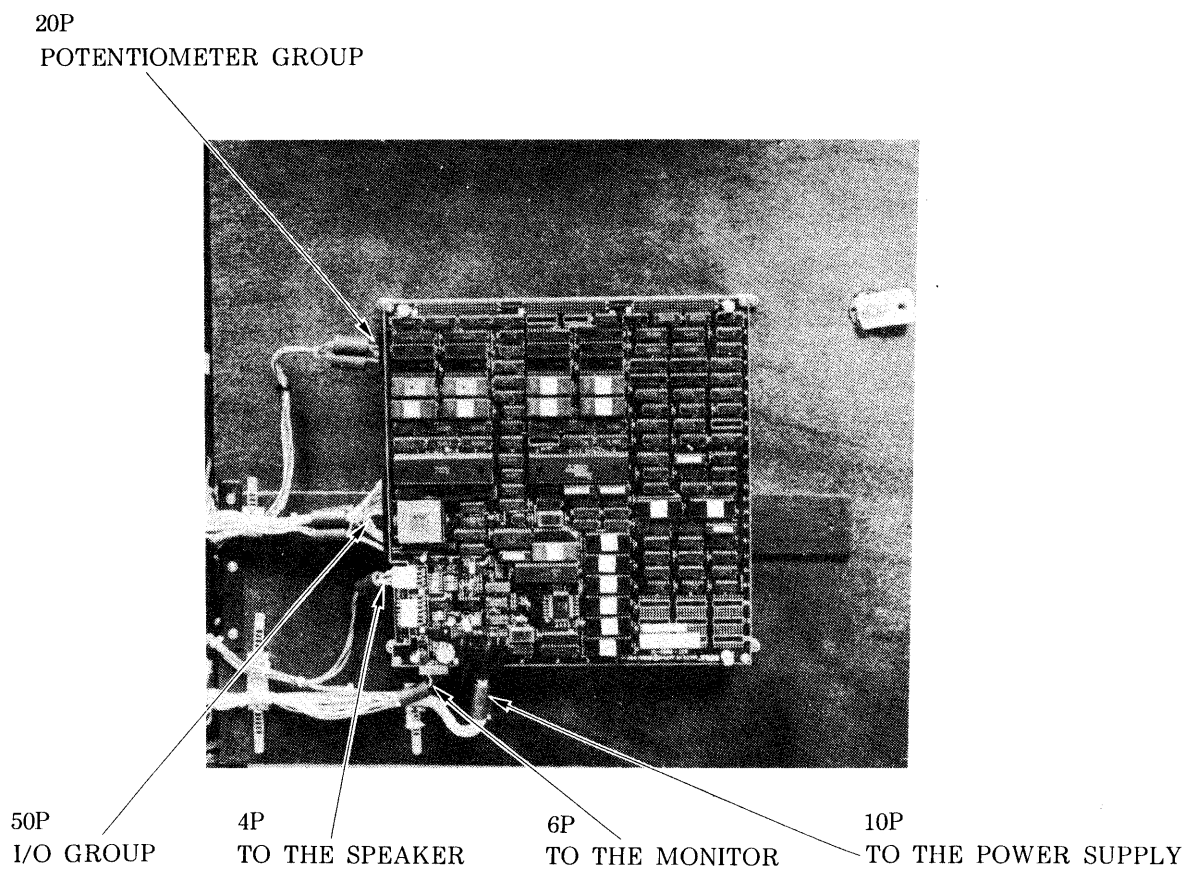

11. DIP SWITCH SETTING

GAME PRICE SETTING

DIP SW A

| OPTION | 1 | 2 | 3 | 4 | 5 | 6 | 7 | 8 |
|-------------------|------------|-----|-----|-----|------------|-----|-----|-----|
| 1 COIN 1 CREDIT | OFF | OFF | OFF | OFF | OFF | OFF | OFF | OFF |
| 1 COIN 2 CREDITS | ON | OFF | OFF | OFF | ON | OFF | OFF | OFF |
| 1 COIN 3 CREDITS | OFF | ON | OFF | OFF | OFF | ON | OFF | OFF |
| 1 COIN 4 CREDITS | ON | ON | OFF | OFF | ON | ON | OFF | OFF |
| 1 COIN 5 CREDITS | OFF | OFF | ON | OFF | OFF | OFF | ON | OFF |
| 1 COIN 6 CREDITS | ON | OFF | ON | OFF | ON | OFF | ON | OFF |
| 2 COINS 1 CREDIT | OFF | ON | ON | OFF | OFF | ON | ON | OFF |
| 3 COINS 1 CREDIT | ON | ON | ON | OFF | ON | ON | ON | OFF |
| 4 COINS 1 CREDIT | OFF | OFF | OFF | ON | OFF | OFF | OFF | ON |
| 2 COINS 3 CREDITS | ON | OFF | OFF | ON | ON | OFF | OFF | ON |
| 2 COINS 1 CREDIT | OFF | ON | OFF | ON | OFF | ON | OFF | ON |
| 3 COINS 2 CREDITS | | | | | | | | |
| 5 COINS 3 CREDITS | | | | | | | | |
| 6 COINS 4 CREDITS | | | | | | | | |
| 2 COINS 1 CREDIT | ON | ON | OFF | ON | ON | ON | OFF | ON |
| 4 COINS 3 CREDITS | | | | | | | | |
| 1 COIN 1 CREDIT | | | | | | | | |
| 2 COINS 2 CREDITS | | | | | | | | |
| 3 COINS 3 CREDITS | OFF | OFF | ON | ON | OFF | OFF | ON | ON |
| 4 COINS 4 CREDITS | | | | | | | | |
| 5 COINS 6 CREDITS | | | | | | | | |
| 1 COIN 1 CREDIT | | | | | | | | |
| 2 COINS 2 CREDITS | ON | OFF | ON | ON | ON | OFF | ON | ON |
| 3 COINS 3 CREDITS | | | | | | | | |
| 4 COINS 5 CREDITS | | | | | | | | |
| 1 COIN 1 CREDIT | OFF | ON | ON | ON | OFF | ON | ON | ON |
| 2 COINS 3 CREDITS | | | | | | | | |
| FREE PLAY | ON | ON | ON | ON | ON | ON | ON | ON |
| | COIN SW #1 | | | | COIN SW #2 | | | |

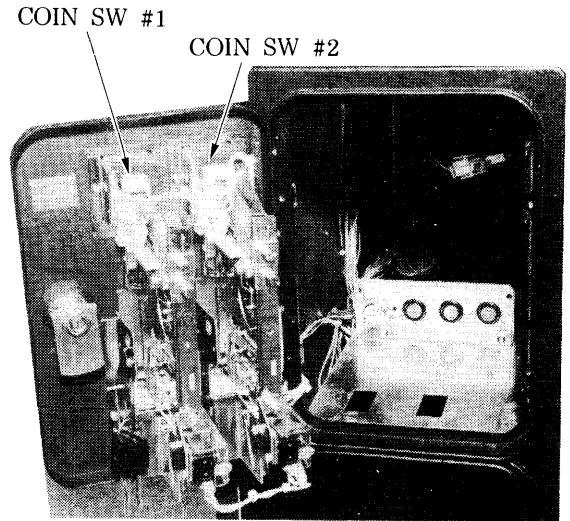

GAME OPTION SETTING

DIP SW B

| OPTION | 1 | 2 | 3 | 4 | 5 | 6 | 7 | 8 |
|------------------------|-----|-----|-----|---|-----|-----|-----|-----|
| TYPE MOVING | OFF | OFF | | | | | | |
| UP COCKPIT | ON | OFF | | | | | | |
| MINI UP | OFF | ON | | | | | | |
| NOT USED | ON | ON | | | | | | |
| ADVERTISE OFF | | | OFF | | | | | |
| SOUND ON | | | ON | | | | | |
| NOT USED | | | | | | | | |
| TIME NORMAL | | | | | OFF | OFF | | |
| EASY | | | | | ON | OFF | | |
| ADJ. HARD | | | | | OFF | ON | | |
| HARDEST | | | | | ON | ON | | |
| NUMBER OF ENEMY NORMAL | | | | | | | OFF | OFF |
| EASY | | | | | | | ON | OFF |
| HARD | | | | | | | OFF | ON |
| HARDEST | | | | | | | ON | ON |

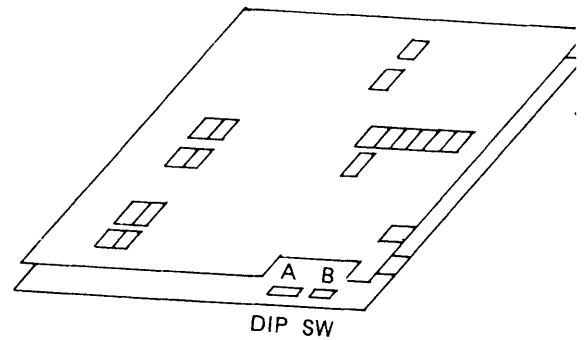

12. EPROM/ROM LOCATIONS

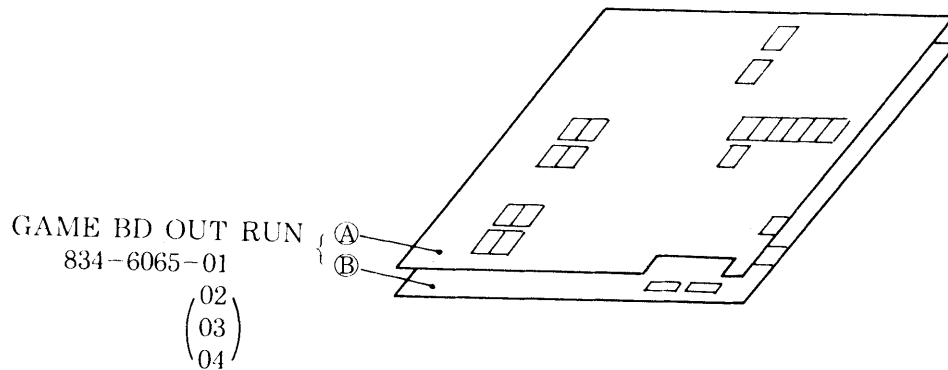

Ⓐ CPU BD OUT RUN 837-6063-02

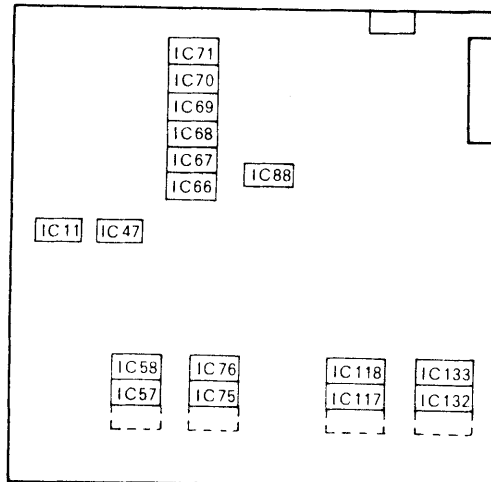

Ⓑ VIDEO BD OUT RUN 837-6064-01 (02)

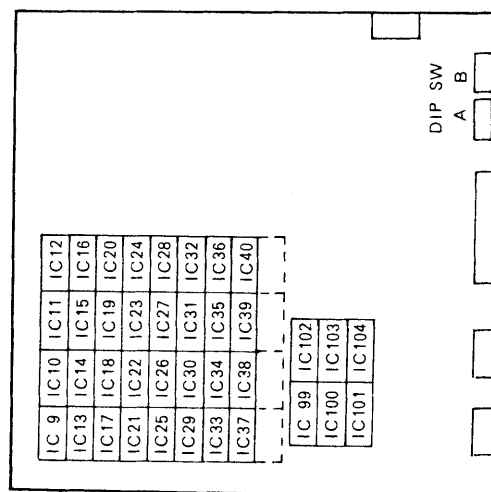

| ONE TIME ROM | | | | |
|----------------|--------|-------------|-------------|---|
| GAME BD | | 834-6065-01 | 834-6065-02 | |
| CPU BD | | 837-6063-01 | 837-6063-02 | |
| Road Character | IC 11 | OPR-10185 | * | |
| | IC 47 | OPR-10186 | | |
| Sub Program | IC 76 | EPR-10327 | EPR-10327A | |
| | IC 75 | EPR-10328 | EPR-10328A | |
| | IC 58 | EPR-10329 | EPR-10329A | |
| | IC 57 | EPR-10330 | EPR-10330A | |
| Main Program | IC 133 | EPR-10331 | EPR-10380 A | |
| | IC 132 | EPR-10332 | EPR-10381 A | |
| | IC 118 | EPR-10333 | EPR-10382 A | |
| | IC 117 | EPR-10334 | EPR-10383 A | |
| Sound | P | IC 88 | EPR-10187 | |
| | Data | IC 71 | OPR-10188 | * |
| | | IC 70 | OPR-10189 | |
| | | IC 69 | OPR-10190 | |
| | | IC 68 | OPR-10191 | |
| | | IC 67 | OPR-10192 | |
| | | IC 66 | OPR-10193 | |
| VIDEO BD | | 837-6064-01 | 837-6064-01 | |
| Object | IC 9 | OPR-10194 | * | |
| | IC 13 | OPR-10195 | | |
| | IC 17 | OPR-10196 | | |
| | IC 21 | OPR-10197 | | |
| | IC 25 | OPR-10198 | | |
| | IC 29 | OPR-10199 | | |
| | IC 33 | OPR-10200 | | |
| | IC 37 | OPR-10201 | | |
| | IC 10 | OPR-10203 | | |
| | IC 14 | OPR-10204 | | |
| | IC 18 | OPR-10205 | | |
| | IC 22 | OPR-10206 | | |
| | IC 26 | OPR-10207 | | |
| | IC 30 | OPR-10208 | | |
| | IC 34 | OPR-10209 | | |
| | IC 38 | OPR-10210 | | |
| | IC 11 | OPR-10212 | | |
| | IC 15 | OPR-10213 | | |
| | IC 19 | OPR-10214 | | |
| | IC 23 | OPR-10215 | | |
| | IC 27 | OPR-10216 | | |
| | IC 31 | OPR-10217 | | |
| | IC 35 | OPR-10218 | | |
| | IC 39 | OPR-10219 | | |
| | IC 12 | OPR-10221 | | |
| | IC 16 | OPR-10222 | | |
| | IC 20 | OPR-10223 | | |
| | IC 24 | OPR-10224 | | |
| | IC 28 | OPR-10225 | | |
| | IC 32 | OPR-10226 | | |
| | IC 36 | OPR-10227 | | |
| | IC 40 | OPR-10228 | | |
| Scroll | IC 104 | OPR-10230 | * | |
| | IC 103 | OPR-10231 | | |
| | IC 102 | OPR-10232 | | |
| | IC 101 | OPR-10266 | | |
| | IC 100 | OPR-10267 | | |
| | IC 99 | OPR-10268 | | |

P : PROGRAM

| MASK ROM | | | | |
|----------------|--------|-------------|-------------|---|
| GAME BD | | 834-6065-03 | 834-6065-04 | |
| CPU BD | | 837-6063-01 | 837-6063-02 | |
| Road Character | IC 11 | OPR-10185 | * | |
| | IC 47 | OPR-10186 | | |
| Sub Program | IC 76 | EPR-10327 | EPR-10327A | |
| | IC 75 | EPR-10328 | EPR-10328A | |
| | IC 58 | EPR-10329 | EPR-10329A | |
| | IC 57 | EPR-10330 | EPR-10330A | |
| Main Program | IC 133 | EPR-10331 | EPR-10380 A | |
| | IC 132 | EPR-10332 | EPR-10381 A | |
| | IC 118 | EPR-10333 | EPR-10382 A | |
| | IC 117 | EPR-10334 | EPR-10383 A | |
| Sound | P | IC 88 | EPR-10187 | |
| | Data | IC 71 | OPR-10188 | * |
| | | IC 70 | OPR-10189 | |
| | | IC 69 | OPR-10190 | |
| | | IC 68 | OPR-10191 | |
| | | IC 67 | OPR-10192 | |
| | | IC 66 | OPR-10193 | |
| VIDEO BD | | 837-6064-02 | 837-6064-02 | |
| Object | IC 9 | MPR-10371 | * | |
| | IC 13 | MPR-10372 | | |
| | IC 10 | MPR-10373 | | |
| | IC 14 | MPR-10374 | | |
| | IC 11 | MPR-10375 | | |
| | IC 15 | MPR-10376 | | |
| | IC 12 | MPR-10377 | | |
| | IC 16 | MPR-10378 | | |
| Scroll | IC 104 | OPR-10230 | * | |
| | IC 103 | OPR-10231 | | |
| | IC 102 | OPR-10232 | | |
| | IC 101 | OPR-10266 | | |
| | IC 100 | OPR-10267 | | |
| | IC 99 | OPR-10268 | | |

* SAME AS THE PREVIOUS COLUMN.

13. SELF-TESTING

The main purposes of these tests are to check the operations of the game boards, to find the defects if any, to adjust the monitor colors properly, and to make sure the sounds are produced satisfactorily. It is also performed to indicate the assignments of the dip switches, check bookkeeping functions, etc.

KIND OF TESTS

- 1) Memory Test: To check the EPROM programs and the map area of the RAMs.
- 2) Input Test: To test the operation of the coin switch, shift lever, handle/accelerator, brake, start switch, service switch, etc.
- 3) Output Test: To test the operation of the lamps.
- 4) Motor Test: Tests in this mode are not applicable for the upright type.
- 5) Sound Test: To check the quality of the sounds produced by the PCB and the video disc, and to adjust the balance of the speakers.
- 6) CRT Test: To check if the colors on the monitor are displayed correctly.
- 7) Dip Switch
Assignment: To indicate each dip switch assignment.
- 8) Bookkeeping: To indicate information data on average score, average play time, etc.
- 9) Backup RAM
Clear: When the power is turned off, a backup battery system automatically takes over, thus allowing the continuous storage of all bookkeeping data. Using this item will enable you to clear said data.
- 10) EXIT See page 22.

1. TEST OPERATION

- (1) Push the test switch and Fig. 1 will be shown on the screen.
- (2) Select CONTINUE or INDIVIDUAL by using the START button.

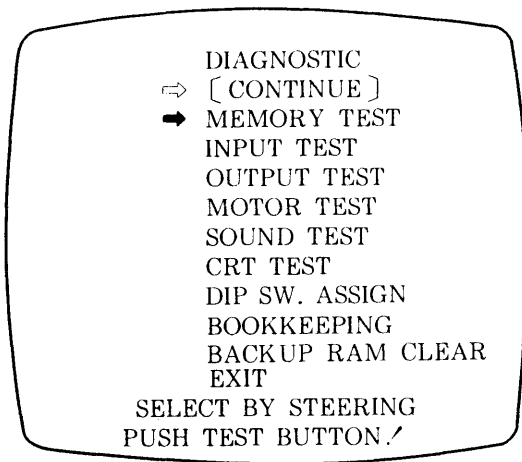

- (3) Move the steering to bring the arrow to the desired position.

FIG. 1

[CONTINUE]:

- o Bring the arrow sign to CONTINUE first, and move it to one of the tests to start. Push the TEST button, and the tests will be performed in order, one by one, starting from the test where the arrow was originally set to EXIT.
- o If the START button is pushed when the arrow is at CONTINUE, it will change to INDIVIDUAL. Pushing it again returns it to CONTINUE.

[INDIVIDUAL]:

- o If the arrow is at INDIVIDUAL first and brought to a certain test which you want to conduct, only that test is performed by pushing the TEST button.

(4) When each test is finished, push the TEST button. In the case of CONTINUE, push the TEST button, and it will automatically go into the following test. If the TEST button is pushed in the case of INDIVIDUAL, FIG. 1 is shown. If you want to end the test mode at this time, bring the arrow to EXIT and push the TEST button again, and it will return to the ADVERTISEMENT mode.

2. TEST ITEMS

(1) Memory Test:

| DIAGNOSTIC MEMORY TEST | | | | | |
|---------------------------|--------|-------|--|--|--|
| ** ROMS TEST ** | | | | | |
| IC 118 | IC 117 | IC 58 | | | |
| IC 133 | IC 132 | IC 76 | | | |
| IC 57 | | | | | |
| IC 75 | | | | | |
| ** RAMS TEST ** | | | | | |
| IC 114 | IC 115 | IC 63 | | | |
| IC 129 | IC 130 | IC 65 | | | |
| IC 64 | IC 95 | IC 52 | | | |
| IC 62 | IC 92 | IC 51 | | | |
| IC 55 | IC 54 | | | | |
| IC 73 | IC 72 | | | | |

Indication of "GOOD" following the IC No. means the IC is all right. Push the TEST button to proceed to the following test item:

(2) Input Test

| DIAGNOSTIC INPUT TEST | | |
|--------------------------|---------|----------|
| COIN #1 | START | |
| COIN #2 | SERVICE | |
| LOW GEAR | | |
| HIGH GEAR | | |
| HANDLE RIGHT LEFT | 80H | } (± 4H) |
| BRAKE | 20H | |
| ACCEL | 20H | |

| | |
|---|---|
| ← HANDLE → | ← ACCELERATOR → |
| 7CH 7DH 7EH 7FH 80H 81H 82H 83H 84H | 1CH 1DH 1EH 1FH 20H 21H 22H 23H 24H |
| Standard value | Standard value |

- o Operate the dip switches. When "ON" is indicated at the right side of the corresponding item on the screen, it is OK.
- o If the data value increases when pressure is applied to the accelerator's or brake's pedal, it tests out satisfactorily.
- o When the tests are ended, push the TEST button.

(3) Output Test

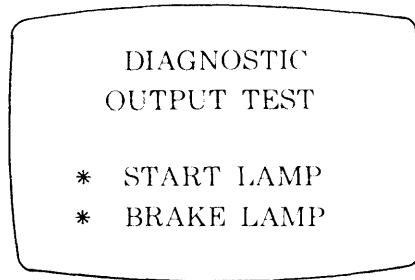

If the start LAMP lights up, it is functioning properly.
Push the TEST button when the testing has been completed.

(4) Sound test

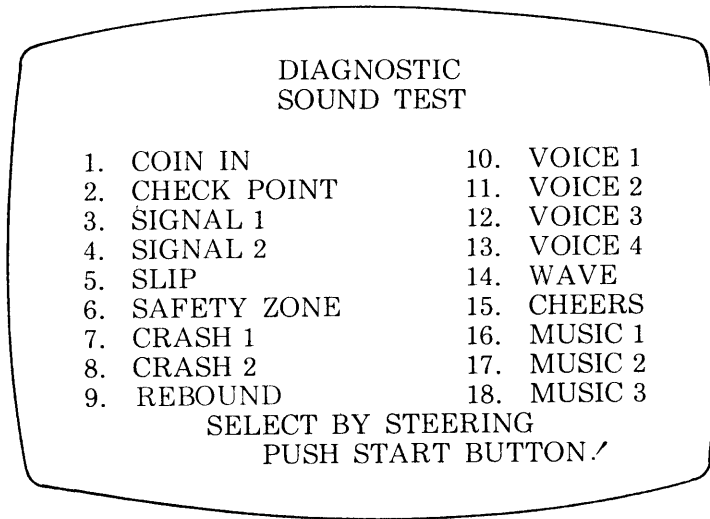

When the test has been completed, push the TEST button.

(5) C.R.T. Test

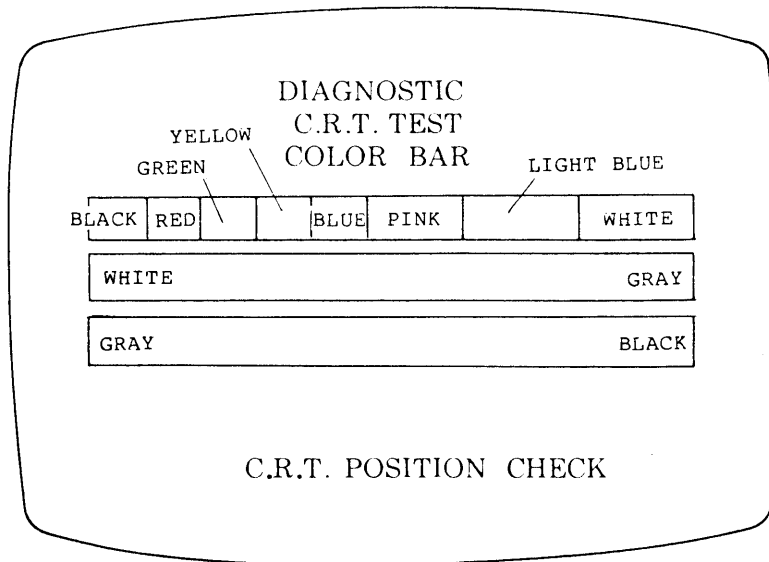

When the test has been completed, push the TEST button.

(6) DIP SWITCH ASSIGNMENTS

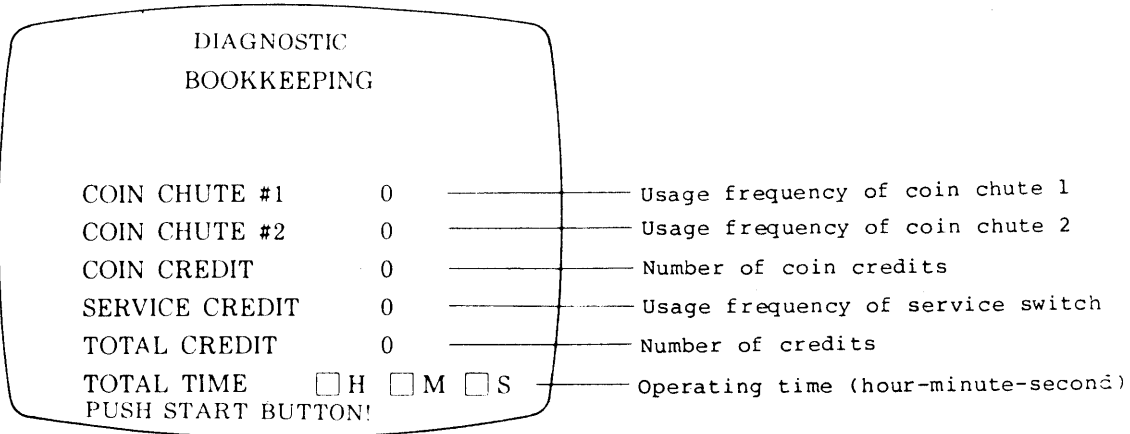
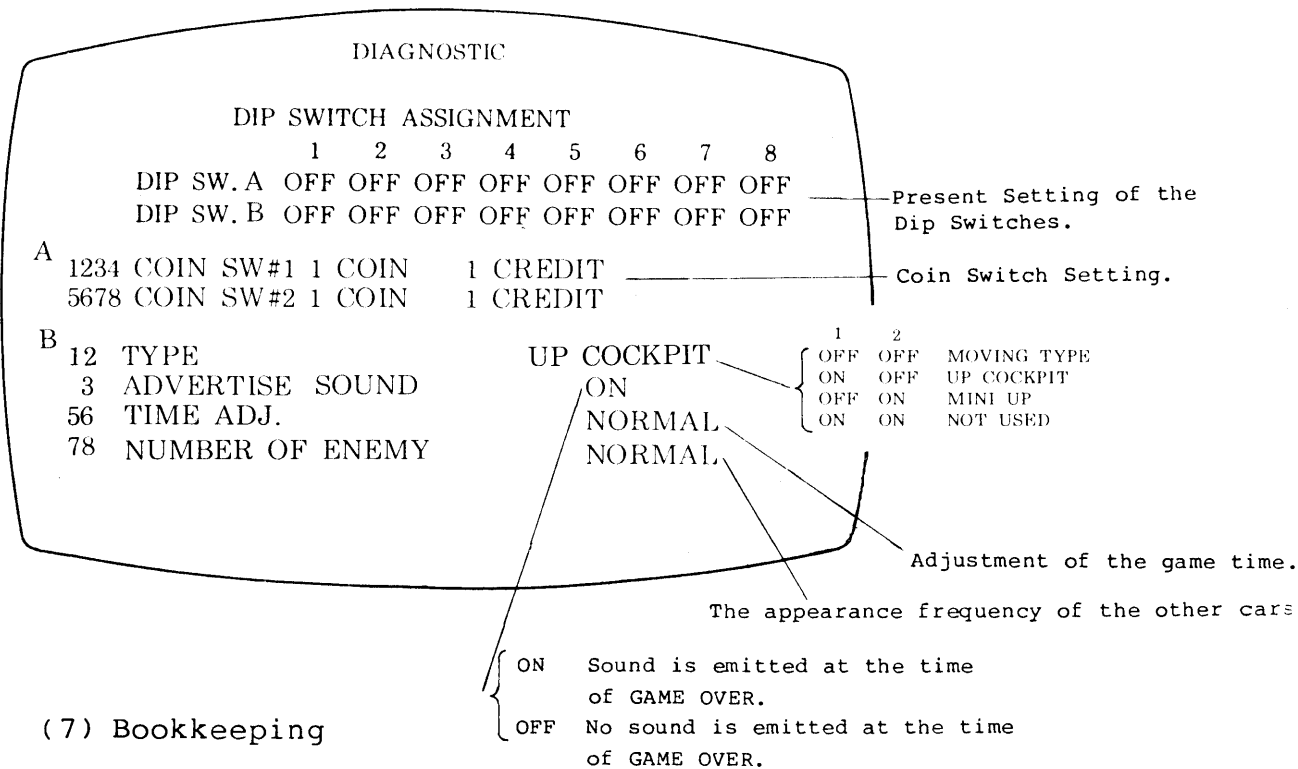

* Only the data that falls within the range of up to 999H 59M 59S can be memorized.

The above screen indication is for testing.
When the tests are finished, push the START button and the following will be shown:

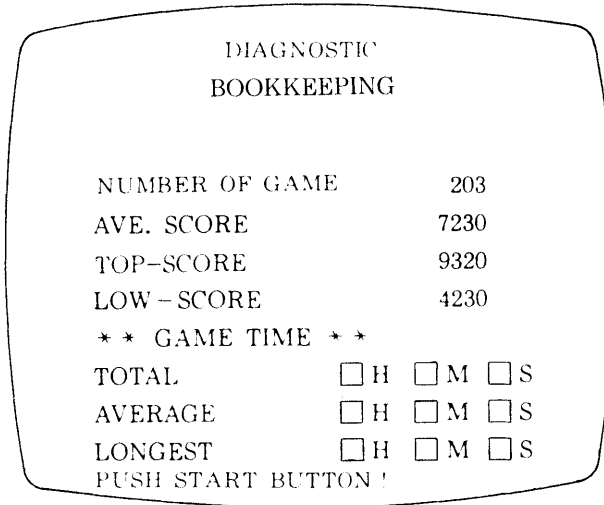

Every time the START button is pressed, the bookkeeping test display is repeated.

o When the tests are ended, push the TEST button.

(8) Backup RAM Clear:

To clear the data, bring the arrow to "YES" and push the TEST button.

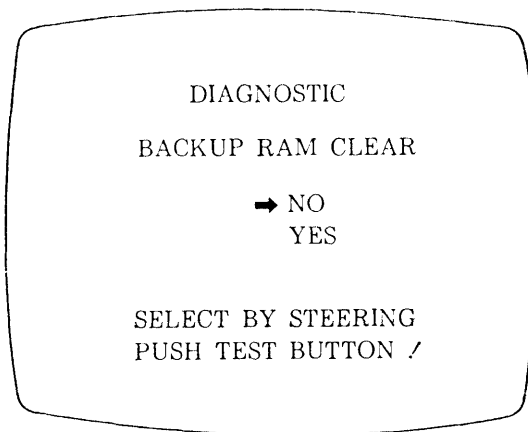

When the test is finished, push the TEST button to end the test (in the case of "INDIVIDUAL," however, the test mode returns to Fig. 1 first).

(9) EXIT

In the state as shown in Fig. 1, operate the steering to bring the arrow to EXIT and push the TEST button. The self-testing will then end and return to the ADVERTISEMENT mode.

14. PARTS LIST

① TOP ASSY OUT RUN U/R USA (KR-00002) (D-1/2)

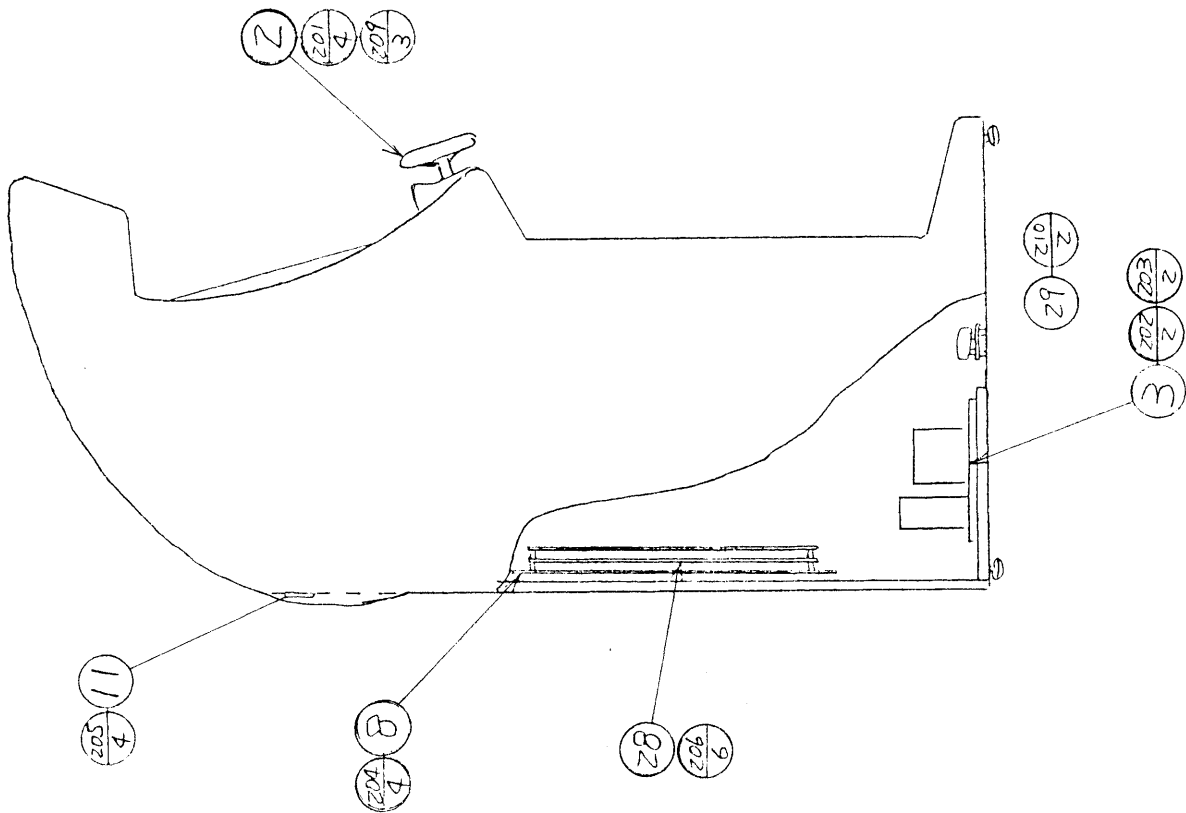
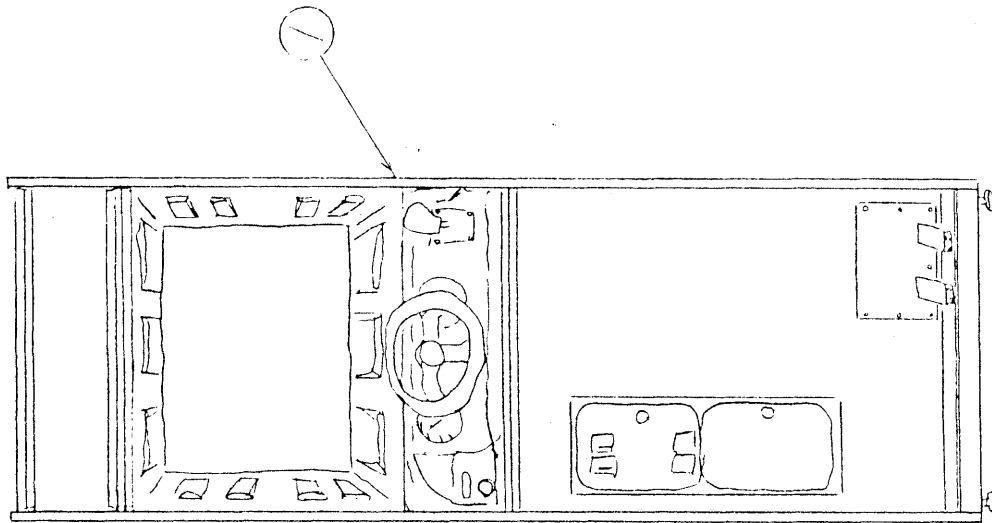

① TOP ASSY OUT RUN U/R USA (KR-00002) (D-2/2)

| ITEM NO. | PART NO. | DESCRIPTION |
|----------|-------------|----------------------------------|
| 1 | KR-10002 | ASSY CABINET U/R USA |
| 2 | KR-11001 | ASSY CONT PANEL |
| 3 | KR-40002 | ASSY PWR SPLY EXPORT |
| 4 | 421-5800-45 | ORIGINAL SEAL OUT RUN |
| 5 | 420-5305-02 | OWNERS MANUAL OUT RUN U/R ENG |
| 6 | 421-6412-01 | ADJ INSTR SH OUT RUN |
| 8 | KR-0013 | SHIELD BASE |
| 10 | 421-6120 | STICKER SEGA USA |
| 11 | 117-5123 | NAMEPLATE ELEC SPECIFICATION USA |
| 12 | 81979 | STICKER SERVICE INSTR |
| 15 | 421-6119 | STICKER FCC |
| 16 | 82789 | STICKER DANGER HIGH VOLTAGE |
| 17 | 83602 | STICKER SERIAL NO INFO |
| 18 | SGM-3640 | POLYETHYLENE COVER HN UPRIGHT |
| 19 | SGM-2675 | POLYETHYLENE BAG 240×370 |
| 20 | SGB-1035X | KEY BAG |
| 21 | 421-6186-1 | DENOMINATION SHEET 1 GAME 2×25¢ |
| 22 | 421-6186-2 | DENOMINATION SHEET 1 GAME 25¢ |
| 23 | 540-0009-01 | WRENCH FOR TAMP SCR M8 |
| 24 | 540-0006-01 | WRENCH FOR TAMP SCR M4 |
| 25 | 540-0007-01 | WRENCH FOR TAMP SCR M5 |
| 26 | 540-0015-01 | WRENCH FOR TAMP TYPE M6 |
| 27 | 220-5130 | *VOL CONT B-5K OHM |
| 28 | 834-6065-02 | GAME BD OUT RUN |
| | 834-6065-04 | GAME BD OUT RUN |
| 29 | 422-0168 | PLAY INSTR STICKER U/R |
| 30 | 420-5318 | DISPLAY MANUAL 20" 200-5090 ENG |
| 201 | 029-0050 | TMP PRF SCR BH M8×30 |
| 202 | 000-0530 | M SCR PH M5×30 |
| 203 | 069-0001 | FLT WSHR 5.5-20×1.6 |
| 204 | 000-0412-FS | M SCR PH W/FS M4×12 |
| 205 | 046-0001 | SCR NAIL THH 1.5×16 |
| 206 | 010-0310-F | S-TITE SCR PH W/F M3×10 |
| 209 | 008-0516 | TMP PRF SCR TH M5×16 |

* Note : VOL CONT refers to the potentiometer.

② ASSY FL & SP UNIT EXPORT (KR-1070)

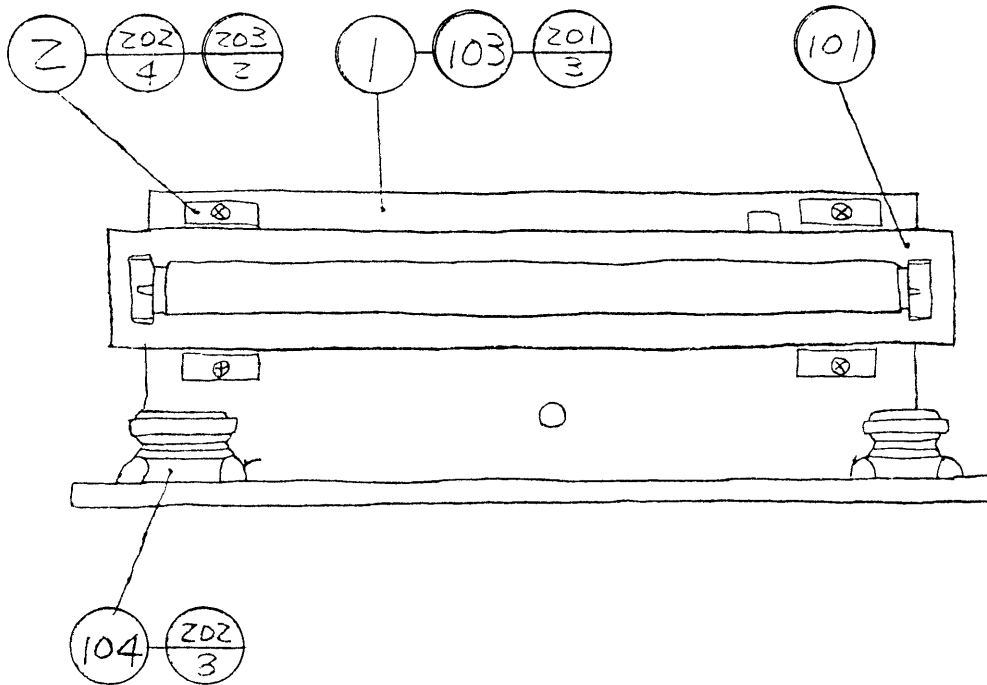

| ITEM NO. | PART NO. | DESCRIPTION |
|----------|-------------|---------------------------------|
| 1 | KR-1067 | FL & SP BASE |
| 2 | VE-1036 | FL BRKT |
| 3 | SGB-3751-5 | WIRE HARN FL & SP UNIT |
| | 211-0087 | CONN PLUG AMP 4P BROWN |
| | 211-0085 | CONN PLUG AMP 2P BROWN |
| | 280-5015 | FASTON RCPT 187 |
| | 209-0023 | CONN CLOSED END |
| 101 | 390-5120-01 | ASSY FL LIGHT 15W 60Hz PALUCK |
| 102 | 211-0041 | CONN PIN AMP |
| 103 | 280-0419 | HARNESS LUG |
| 104 | 130-5001 | SPEAKER 8 OHM \varnothing 120 |
| 201 | 005-3510 | W SCR .RH 3.5x10 |
| 202 | 005-3513-F | W SCR RH W/F 3.5x13 |
| 203 | 010-0406-F | S-TITE SCR PH W/F M4x6 |

③ ASSY SUB-CABINET U/R USA (KR-1600) (D-1/2)

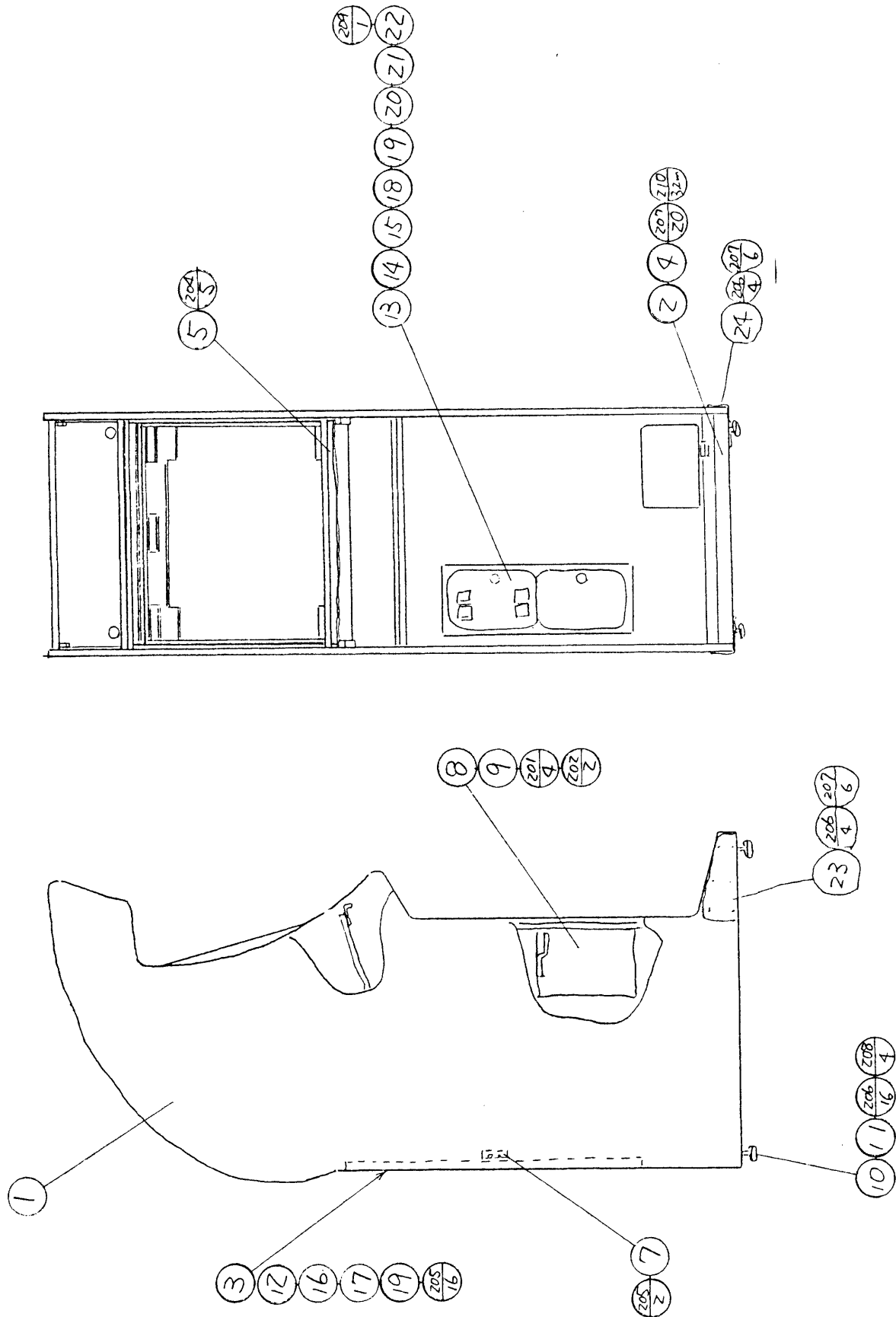

③ ASSY SUB - CABINET U/R USA (KR - 1600) (D-2/2)

| ITEM NO. | PART NO. | DESCRIPTION |
|----------|-------------|----------------------------------|
| 1 | KR-1601 | WODDEN CABINET |
| 2 | KR-1602 | SUPPORT BRACKET |
| 3 | KR-1603 | BACK DOOR |
| 4 | KR-1604 | FLOOR MAT |
| 5 | KR-1605 | BRACKET HOLDER |
| 7 | SH-2061X | STOPPER |
| 8 | KR-1606 | COVER CASHBOX |
| 9 | KR-1608 | LOCK BRACKET |
| 10 | TI-1079 | LEG ADJUSTOR BRKT |
| 11 | 601-0455 | LEG ADJUSTOR |
| 12 | TA-1010 | HINGE 148 |
| 13 | 220-5128-03 | ASSY COIN CHUTE 2 DOOR USA 254×2 |
| 14 | HN-1050 | SPACE RING |
| 15 | DP-1167 | TNG LKG |
| 16 | DP-1148X | LKG TNG |
| 17 | 117-0062 | PLATE LOCK RETAINER |
| 18 | 109-0045 | KEY HOLDER |
| 19 | 220-5044-01 | MAG LOCK W/O KEY |
| 20 | 220-5045-01 | KEY MASTER FOR 220-5044-01 |
| 21 | 220-5046 | MAG LOCK W/KEYS |
| 22 | SGB-3751-16 | WIRE HARN COIN SW |
| | 211-0073 | CONN PLUG AMP 4P WHITE |
| | 280-5016 | FASTON RCPT 205 |
| | 280-0425 | CORD CLAMP \varnothing 10 |
| 23 | KR-1609 | BRACKET UNDER RIGHT |
| 24 | KR-1610 | BRACKET UNDER LEFT |
| 101 | 211-0041 | CONN PIN AMP |
| 201 | 000-0406-S | M SCR PH W/S M4×6 |
| 202 | 000-0408-S | M SCR PH W/S M4×8 |
| 204 | 000-0516-S | M SCR PH W/S M5×16 |
| 205 | 005-3516-F | W SCR RH W/F 3.5×16 |
| 206 | 000-0520-S | M SCR PH W/S M5×20 |
| 207 | 046-0001 | SCR NAIL |
| 208 | 059-0007 | HEX NUT 3/8-16 |
| 209 | 000-0306-S | M SCR PH W/S M3×6 |
| 210 | 244-063 | DOUBLE FACE TAPE 20mm |

④ ASSY CABINET U/R USA (KR-10002) (D-1/3)

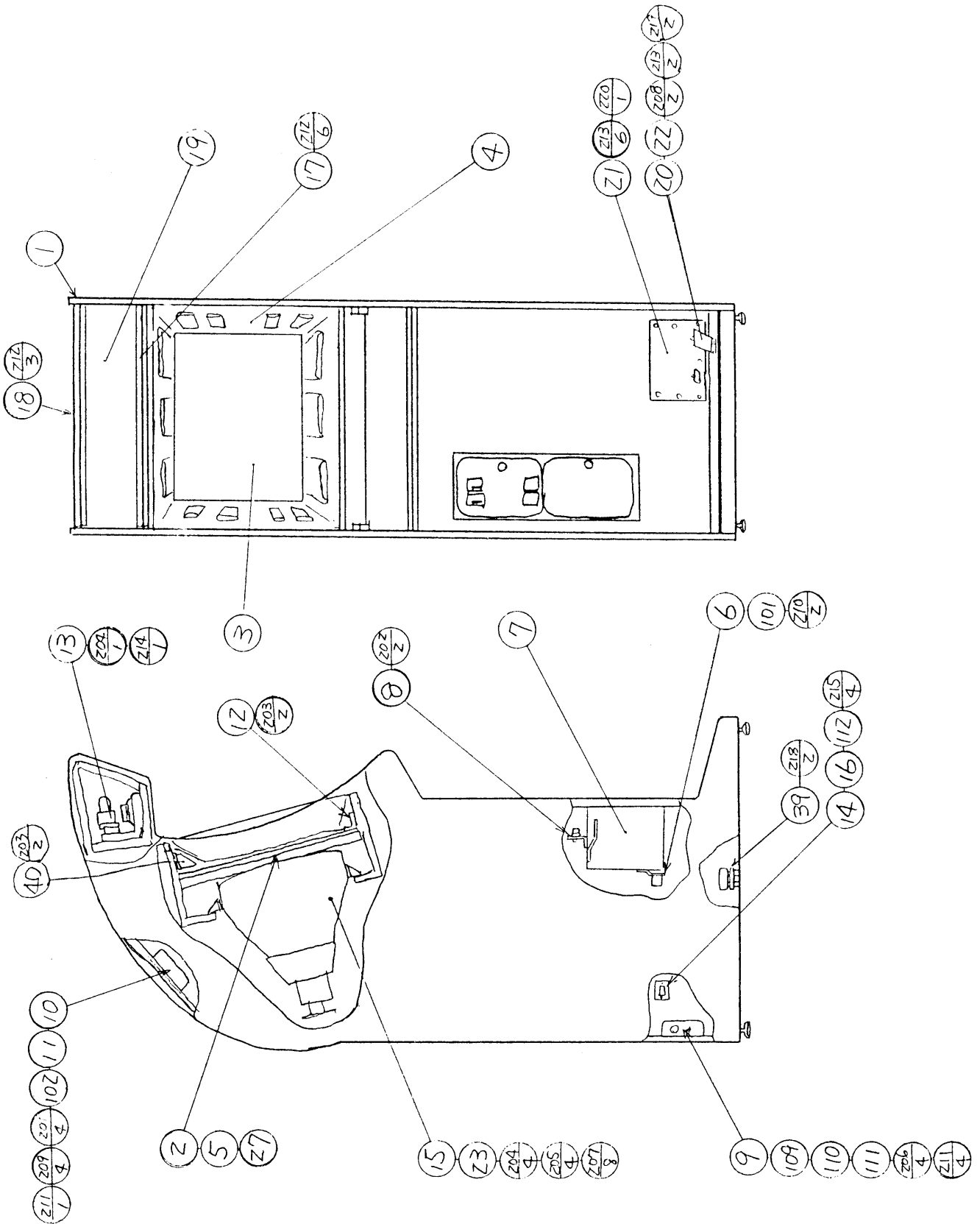

④ ASSY CABINET U/R USA (KR--10002) (D-2/3)

| ITEM NO. | PART NO. | DESCRIPTION |
|----------|-------------|----------------------------|
| 1 | KR-1600 | ASSY SUB-CABINET U/R |
| 2 | HN-1038 | MASK BOARD |
| 3 | HN-1039X | WINDOW GLASS |
| 4 | KR-1068 | WINDOW MASK |
| 5 | AB-1206 | TV MASK 20 |
| 6 | RA-1016 | METER BRKT |
| 7 | KR-1607 | CASHBOX |
| 8 | KR-1720 | SP UNIT |
| 9 | MO-1215Y | COVER |
| 10 | HN-1042 | FAN BRKT |
| 11 | MO-1051Y | GUARD PLATE |
| 12 | HN-1040 | HOLDER BRKT |
| 13 | KR-1070 | ASSY FL & SP UNIT EXPORT |
| 14 | 105-0064 | BRKT MAIN SW |
| 15 | 200-5090 | ASSY CLR DSPL 20 TYPE 100V |
| 16 | 409-0049 | SW STOPPER 1/2 |
| 17 | KR-1064X | FRAME LOWER |
| 18 | KR-1065X | FRAME UPPER |
| 19 | 423-0031 | DESIGN PLATE OUTRUN |
| 20 | KR-1071 | ACCEL & BRAKE PEDAL |
| 21 | KR-12002 | ASSY ACCEL & BRAKE U/R |
| 22 | KR-1073 | SHAFT |
| 23 | TY-1019 | BRKT TV |
| 24 | SGB-3751-17 | WIRE HARN EARTH |
| | 211-0167 | TERMINAL LUG ROUND ID 5 |
| 25 | SGB-3751-3 | WIRE HARN FAN MOTOR |
| | 211-0085 | CONN PLUG AMP 2P BROWN |
| 26 | SGB-3751-4 | WIRE HARN EXT AC 100V |
| | 600-5133 | CABLE & CONN 300L |
| | 211-0085 | CONN PLUG AMP 2P BROWN |
| | 211-0080 | CONN CAP AMP 2P BROWN |
| | 211-0117 | CONN CAP AMP 2P YELLOW |
| | 209-0032 | CONN CLOSED END |
| 27 | AB-1151Y | TV MASK GRAY SMOKE |
| 28 | SGB-3751-6 | WIRE HARN EXT FL |
| | 211-0085 | CONN PLUG AMP 2P BROWN |
| | 211-0080 | CONN CAP AMP 2P BROWN |
| 29 | SGB-3751-7 | WIRE HARN EXT SP |
| | 211-0087 | CONN PLUG AMP 4P BROWN |
| | 211-0082 | CONN CAP AMP 4P BROWN |
| 30 | SGB-3751-9 | WIRE HARN 50P |
| | 211-5105 | CONN FEM 50P |
| | 211-0102 | CONN PLUG AMP 4P YELLOW |
| | 211-0044 | CONN CAP AMP 2P WHITE |
| | 211-0080 | CONN CAP AMP 2P BROWN |
| | 211-0121 | CONN CAP AMP 4P RED |
| | 211-0081 | CONN CAP AMP 3P BROWN |
| | 211-0072 | CONN CAP AMP 4P WHITE |
| | 211-0082 | CONN CAP AMP 4P BROWN |
| | 212-5033 | CONN FEM 2P |
| | 270-5016 | FERRITE SLEEVE CORE |
| 31 | SGB-3751-10 | WIRE HARN 20P |
| | 211-5088 | CONN FEM 20P |
| | 211-0060 | CONN CAP AMP 3P WHITE |
| | 211-0046 | CONN CAP AMP 6P WHITE |
| | 270-5016 | FERRITE SLEEVE CORE |

④ ASSY CABINET U/R USA (KR-10002) (D-3/3)

| ITEM NO. | PART NO. | DESCRIPTION |
|----------|-------------|----------------------------------|
| 32 | SGB-3751-11 | WIRE HARN RG8 |
| | 211-0044 | CONN CAP AMP 2P WHITE |
| | 211-0060 | CONN CAP AMP 3P WHITE |
| | 212-5034 | CONN FEM 6P |
| | 270-5016 | FERRITE SLEEVE CORE |
| 33 | SGB-3751-15 | WIRE HARN COIN METER |
| | 211-0087 | CONN PLUG AMP 4P BROWN |
| | 209-0023 | CONN CLOSED END |
| 34 | SGB-3751-2 | WIRE HARN AC |
| | 211-0118 | CONN CAP AMP 3P RED |
| | 209-0023 | CONN CLOSED END |
| | 280-5015 | FASTON RLPT 187 |
| 35 | HN-1069 | RUBBER CUSHION |
| 36 | 80931 | STICKER COIN METER |
| 37 | 83005 | STICKER MAIN SW PUSH ON PUSH OFF |
| 38 | SGB-3751-18 | WIRE HARN EXT DC |
| | 211-0096 | CONN PLUG AMP 2P YELLOW |
| | 211-0115 | CONN CAP AMP 2P RED |
| | 212-5034 | CONN FEM 6P |
| 39 | 839-0048 | SSR BD DC MOTOR |
| 40 | KR-1612 | BRACKET |
| 101 | 220-5064 | MAG CNTR 601G DC SV |
| 102 | 260-0011 | AXIAL FLOW FAN AC 100V 50~60Hz |
| 103 | 280-0419 | HARNES LUG |
| 104 | 211-0041 | CONN PIN AMP |
| 105 | 211-0042 | CONN SOCKET AMP |
| 106 | 211-0005 | CONTACT |
| 107 | 280-5008 | CORD CLAMP \varnothing 15 |
| 108 | 280-0425 | CORD CLAMP \varnothing 10 |
| 109 | 280-0418 | BUSHING STRAIN RELIEF 8.3 |
| 110 | 280-0417 | TERMINAL BINDING POST BLACK |
| 111 | 600-0110 | CA & PL ASSY |
| 112 | 509-0039 | SW PB TYPE |
| 113 | 211-0005 | CONN CLAMP LOCK |
| 201 | 000-0310-FS | M SCR PH W/FS M3×10 |
| 202 | 000-0408-S | M SCR PH W/S M4×8 |
| 203 | 000-0416-FS | M SCR PH W/FS M4×16 |
| 204 | 069-0001 | FLT WSHR 5.5-20×1.6 |
| 205 | 000-0520-S | M SCR PH W/S M5×20 |
| 206 | 031-0425-B | CRG BLT-BLK M4×25 |
| 207 | 000-0510-S | M SCR PH W/S M5×10 |
| 208 | 065-0004 | E RING 4mm |
| 209 | 008-0425 | TMP PRF SCR TH M4×25 |
| 210 | 010-0408-F | S-TITE SCR PH W/F M4×8 |
| 211 | 051-0004 | FLG NUT M4 |
| 212 | 008-0516 | TMP PRF SCR TH M5×16 |
| 213 | 008-0520 | TMP PRF SCR TH M5×20 |
| 214 | 000-0530 | M SCR PH M5×30 |
| 215 | 005-3513-F | W SCR RH W/F 3.5×13 |
| 216 | 005-3510 | W SCR PH 3.5×10 |
| 217 | 006-3110 | W SCR FH 3.1×10 |
| 218 | 005-3520 | W SCR PH 3.5×20 |
| 219 | 060-0006 | FLT WSHR M6 |
| 220 | 008-0535 | TMP PRF SCR TH M5×35 |
| 221 | 008-0416 | TMP PRF SCR TH M4×16 |

⑤ ASSY CONTROL PANEL (KR-11001) (D-1/3)

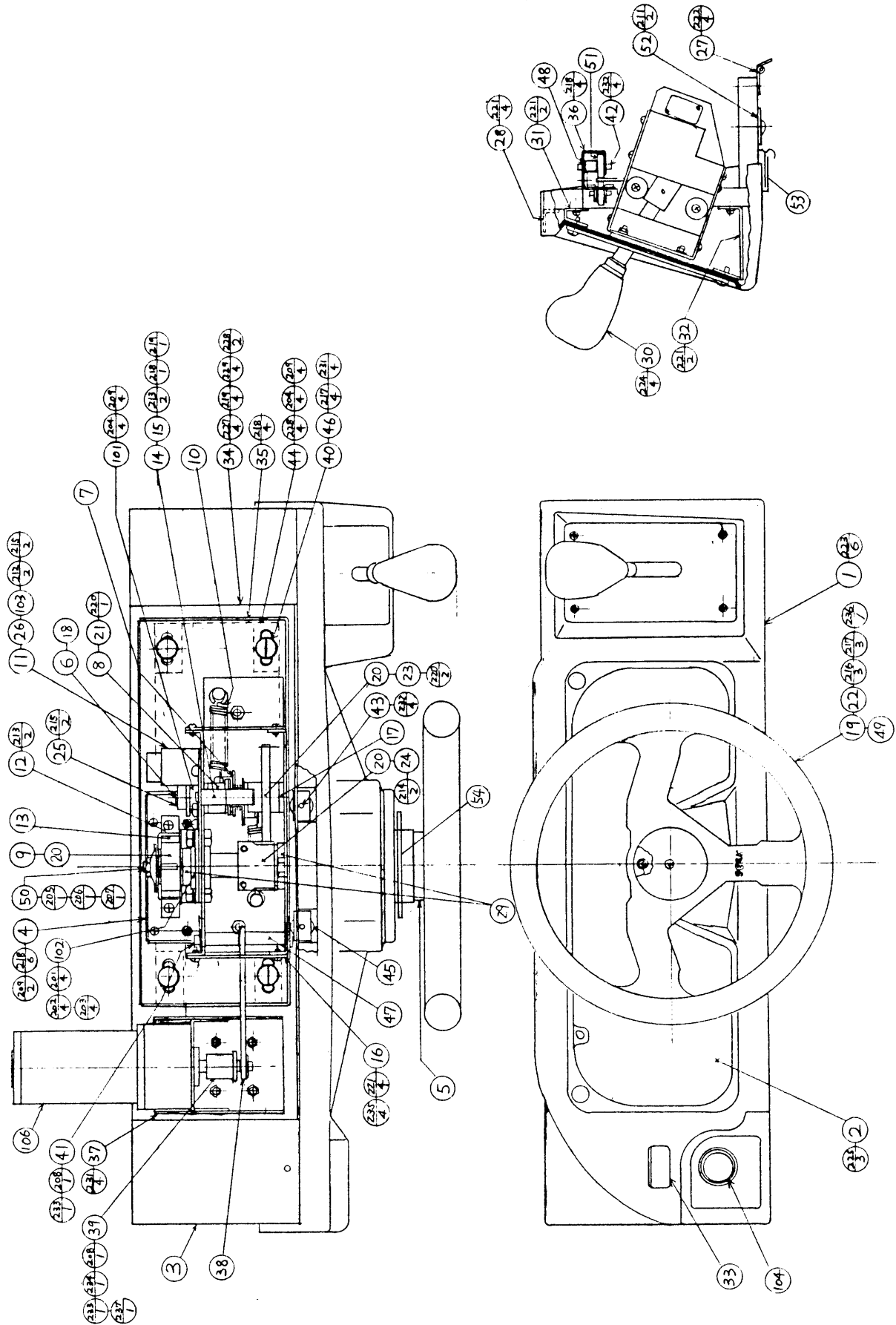

⑤ ASSY CONTROL PANEL (KR-11001) (D-2/3)

| ITEM NO. | PART NO. | DESCRIPTION |
|----------|----------|-----------------------------------|
| 1 | KR-1133 | CONTROL PANEL |
| 2 | KR-1134 | METER PANEL |
| 3 | KR-1132 | CONT WOODEN BASE |
| 4 | KR-1105X | HANDLE BASE |
| 5 | KR-1106X | STEERING WHEEL SHAFT |
| 6 | KR-1107 | SHAFT |
| 7 | KR-1108 | ARM PLATE |
| 8 | KR-1109X | ARM BAR |
| 9 | KR-1110Y | STEERING WHEEL STOPPER |
| 10 | KR-1111X | EXTENSION SPRING |
| 11 | KR-1112 | VOLUME BRACKET |
| 12 | KR-1113 | BUMPER BRACKET |
| 13 | KR-1114 | BUMPER |
| 14 | KR-1115 | STOPPER |
| 15 | KR-1116 | RUBBER STOPPER |
| 16 | KR-1117 | PLATE |
| 17 | KR-1119 | COLLAR B |
| 18 | KR-1120 | SPACER A |
| 19 | KR-1121X | STEERING HANDLE $\varnothing 270$ |
| 20 | KR-1122 | KEY A |
| 21 | KR-1123 | KEY B |
| 22 | KR-1125X | HANDLE EMBLEM |
| 23 | KR-1126 | GEAR A |
| 24 | KR-1127 | GEAR B |
| 25 | KR-1128 | GEAR C |
| 26 | KR-1129 | GEAR D |
| 27 | KR-1130 | HINGE 590 |
| 28 | KR-1131 | BRACKET |
| 29 | KR-1118 | COLLAR A |
| 30 | KR-13001 | ASSY SHIFT LEVER S |
| 31 | KR-1141 | BRACKET A |
| 32 | KR-1142 | BRACKET B |
| 33 | 117-5133 | START PLATE |
| 34 | KR-1143 | BASE |
| 35 | KR-1144 | SLIDE BASE |
| 36 | KR-1145 | ROLLER BRACKET |
| 37 | KR-1146 | MOTOR BRACKET |
| 38 | KR-1147 | ROD |
| 39 | KR-1148 | CAM |
| 40 | KR-1149 | SHOULDER SCREW |
| 41 | KR-1150 | SHAFT |
| 42 | KR-1151 | SHAFT LONG |
| 43 | KR-1152 | SHAFT SHORT |
| 44 | KR-1153 | SLIDE PLATE |
| 45 | KR-1154 | ROLLER A |
| 46 | KR-1155 | PLASTIC WASHER |
| 47 | KR-1156 | COLLAR |
| 48 | KR-1157 | SPACER |
| 49 | KR-1165 | SPACER |
| 50 | KR-1137 | STOPPER WASHER |
| 51 | KR-1164 | ROLLER B |
| 52 | KR-1171 | PLATE |
| 53 | KR-1173 | COVER PLATE |
| 54 | KR-1174 | SPACER |

⑤ ASSY CONTROL PANEL (KR-11001) (D-3/3)

| ITEM NO. | PART NO. | DESCRIPTION |
|----------|-------------|--|
| | SGB-3751-13 | WIRE HARN HANDLE VR |
| | 211-0059 | CONN PLUG AMP 3P WHITE |
| | SGB-3751-14 | WIRE HARN START SW |
| | 211-0100 | CONN PLUG AMP 4P RED |
| | 280-0472 | FASTON RCPT 110 |
| | SGB-3751-19 | WIRE HARN DC MOTOR |
| | 211-0094 | CONN PLUG AMP 2P |
| | 209-0023 | CONN CLOSED END |
| 101 | 100-5015 | BEARING \varnothing 10 |
| 102 | 100-5035 | BEARING \varnothing 20 |
| 103 | 220-5130 | VOL CONT B-5K OHM |
| 104 | 509-5053 | PUSH BTN SWITCH GREEN W/LAMP |
| 105 | 211-0041 | CONN PIN AMP |
| 106 | 350-5086 | MOTOR DC 45V |
| 107 | 280-5008 | CORD CLAMP \varnothing 15 |
| 108 | 280-0419 | HARNESS LUG |
| 109 | 601-0460 | TIE BELT |
| 201 | 030-0825 | HEX BLT M8 \times 25 |
| 202 | 060-0008 | FLT WSHR M8 |
| 203 | 061-0008 | SPR WSHR M8 |
| 204 | 054-0005 | U NUT M5 |
| 205 | 050-0010 | HEX NUT M10 |
| 206 | 069-0009 | FLT WSHR 10.5-28 \times 2 |
| 207 | 061-0010 | SPR WSHR M10 |
| 208 | 060-0010 | FLT WSHR M10 |
| 209 | 060-0005 | FLT WSHR M5 |
| 211 | 008-0512 | TMP PRF SCR TH M5 \times 12 |
| 212 | 000-0408-FS | M SCR PH WFS M4 \times 8 |
| 213 | 000-0510-FS | M SCR PH W/FS M5 \times 10 |
| 214 | 028-0010 | SET SCR HEX SKT CP M5 \times 8 |
| 215 | 028-0014 | SET SCR HEX SKT CP UNBR M4 \times 4 |
| 216 | 029-0078 | TMP PRF SCR TH M6 \times 16 |
| 217 | 061-0006 | SPR WSHR M6 |
| 218 | 000-0510-S | M SCR PH W/S M5 \times 10 |
| 219 | 069-0022 | FLT WSHR 5.5-14 \times 1 |
| 220 | 028-0007 | SET SCR HEX SKT CP UNBR M4 \times 10 |
| 221 | 000-0416-FS | M SCR PH M4 \times 16 W/FS |
| 222 | 008-0516 | TMP PRF SCR TH M5 \times 16 |
| 223 | 008-0416 | TMP PRF SCR TH M4 \times 16 |
| 224 | 008-0408 | TMP PRF SCR TH M4 \times 8 |
| 225 | 001-0420 | M SCR FHT M4 \times 20 |
| 227 | 000-0514-S | M SCR PH 5 \times 14 W/S |
| 228 | 001-0516 | M SCR FH 5 \times 16 |
| 229 | 005-3516 | W SCR RH 3.5 \times 16 |
| 231 | 054-0006 | U NUT M6 |
| 232 | 045-0003 | COT PIN 1.6 \times 12 |
| 233 | 045-0005 | COT PIN 2 \times 15 |
| 234 | 028-0012 | SET SCR CHEESE HEAD SPECIAL M5 \times 12 |
| 235 | 054-0004 | U NUT M4 |
| 236 | 008-0425 | TMP PRF SCR TH M4 \times 25 |
| 237 | 045-0014 | SPR PIN UNBR 3 \times 26 |
| 238 | 005-3113 | W SCR RH 3.1 \times 13 |
| 239 | 006-3113 | W SCR FH 3.1 \times 13 |

⑥ ASSY ACCEL & BRAKE U/R (KR-12002) (D-1/2)

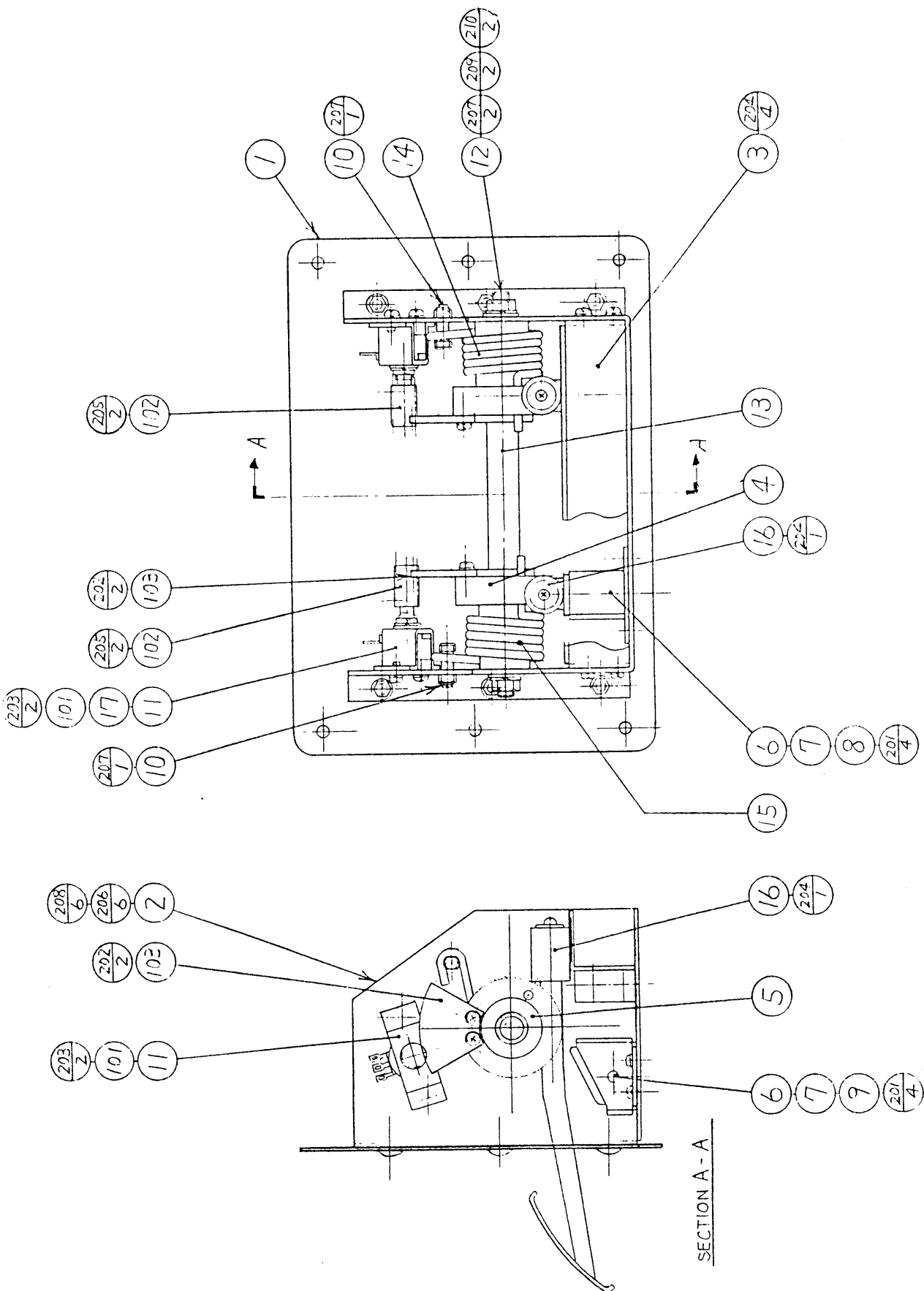

⑥ ASSY ACCEL & BRAKE U/R (KR-12002) (D-2/2)

| ITEM NO. | PART NO. | DESCRIPTION |
|----------|-------------------------|--|
| 1 | KR-1216 | LID |
| 2 | KR-1217 | PEDAL BRACKET |
| 3 | KR-1218 | STOPPER BRACKET |
| 4 | KR-1219 | ACCEL BAR |
| 5 | KR-1220 | BRAKE BAR AND PEDAL |
| 6 | KR-1221 | BUMPER BRACKET A |
| 7 | KR-1222X | BUMPER BRACKET B |
| 8 | KR-1223 | BUMPER A |
| 9 | KR-1224 | BUMPER B |
| 10 | KR-1225 | SPRING STOPPER |
| 11 | KR-1205 | VR BRACKET |
| 12 | KR-1208 | SHAFT BRAKE ACCEL |
| 13 | KR-1209 | COLLAR |
| 14 | KR-1210 | TORSION SPRING A |
| 15 | KR-1211 | TORSION SPRING B |
| 16 | KR-1213 | BUMPER |
| 18 | SGB-3751-12 211-0045 | WIRE HARN ACCEL & BRAKE VR CONN PLUG AMP 6P WHITE |
| 101 | 220-5130 | VOL CONT B-5K OHM |
| 102 | 601-5410 | GEAR 15 \varnothing 6 |
| 103 | 601-5423 | GEAR 1/6 |
| 104 | 211-0041 | CONN PIN AMP |
| 105 | 280-5008 | CORD CLAMP \varnothing 15 |
| 106 | 601-0460 | TIE BELT |
| 201 | 000-0406-S | M SCR PH W/S M4x6 |
| 202 | 000-0408-S | M SCR PH W/S M4x8 |
| 203 | 000-0408-FS | M SCR PH W/FS M4x8 |
| 204 | 000-0510-FS | M SCR PH W/FS M5x10 |
| 205 | 028-0002 | SET SCR PH SPCL M3x6 |
| 206 | 031-0514-B | CRG BLT BLK M5x14 |
| 207 | 050-0008 | HEX NUT M8 |
| 208 | 051-0005 | FLG NUT M5 |
| 209 | 060-0008 | FLT WSHR M8 |
| 210 | 061-0008 | SPR WSHR M8 |

⑦ ASSY SHIFT LEVER S (KR-13001) (D-1/2)

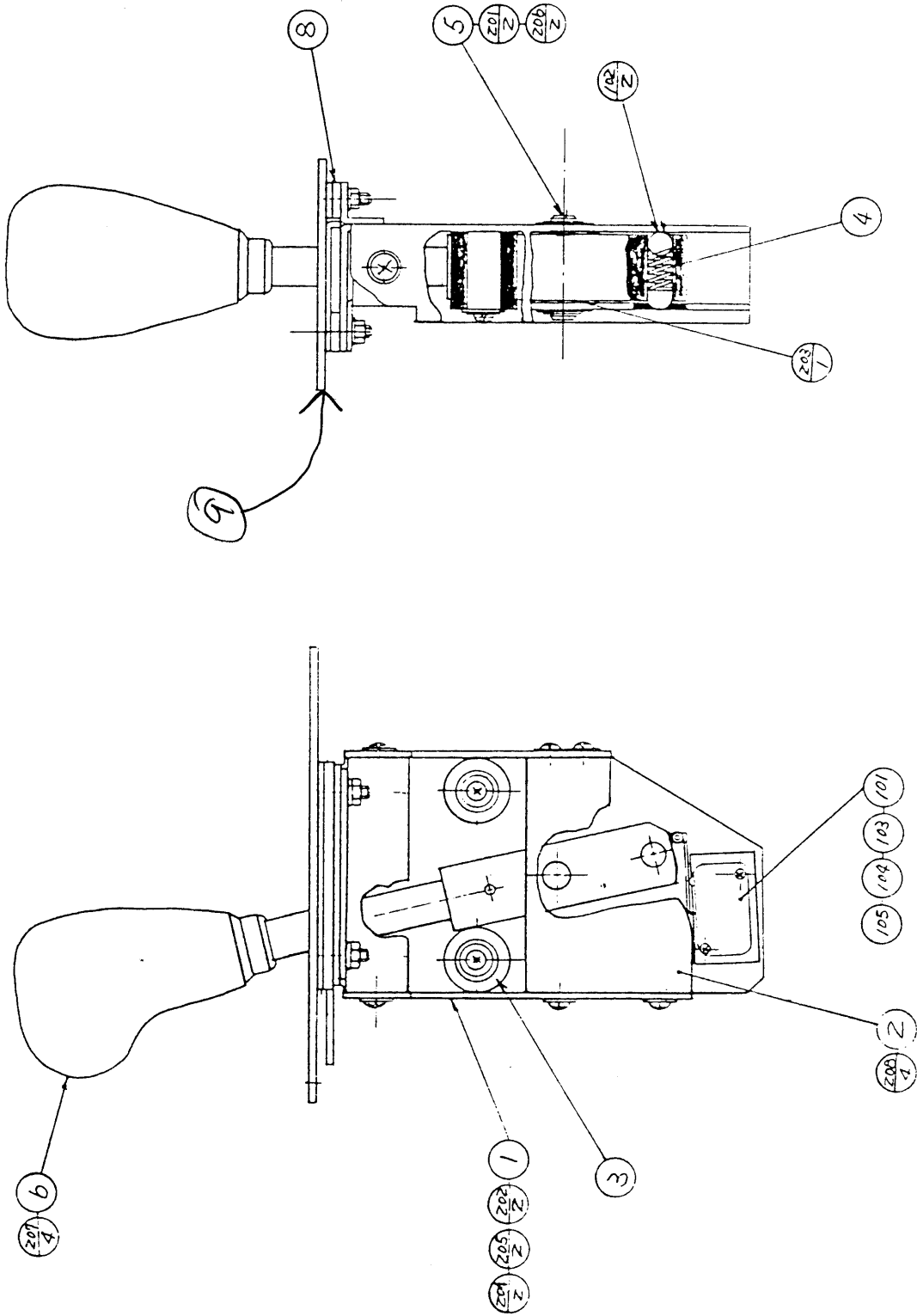

⑦ ASSY SHIFT LEVER S (KR-13001) (D-2/2)

| ITEM No. | PART No. | DESCRIPTION |
|----------|-------------|---------------------------------|
| 1 | KR-1312 | SHIFT BRACKET B |
| 2 | KR-1314 | COVER BRACKET B |
| 3 | KR-1303 | STOPPER |
| 4 | KR-1320 | COMPRESSION SPRING |
| 5 | KR-1304 | SHAFT |
| 6 | KR-1315 | SUB ASSY SHIFT LEVER |
| 7 | SGB-3740-5 | WIRE HARN SHIFT SW |
| | 211-0043 | CONN PLUG AMP 2P WHITE |
| | 280-5015 | FASTON RCPT 187 |
| 8 | KR-1316 | SPACER |
| 9 | KR-1318 | MOUNT BRACKET |
| 101 | 211-0041 | CONN PIN AMP |
| 102 | 101-5004 | STEEL BALL \varnothing 8.7312 |
| 103 | 509-5088 | SW MICRO TYPE |
| 104 | 310-0012 | PAPER INSULATOR |
| 105 | 117-0141 | LOCK PLATE |
| 201 | 069-0005 | FLT WHIR SPECIAL 8.3-14.3×0.5 |
| 202 | 000-0408-FS | M SCR PH W/FS M4×8 |
| 203 | 069-0049 | NYLON WASHER SPECIAL 8.5-14×1 |
| 204 | 000-0316 | M SCR PH M3×16 |
| 205 | 069-0007 | FLT WSHR |
| 206 | 065-0006 | E RING 6mm |
| 207 | 054-0004 | M4 U NUT |
| 208 | 010-0408-F | S-TITE SCR W/F M4×8 |

⑧ ASSY PWR SPLY EXPORT (KR-40002) (D-1/2)

| ITEM NO. | PART NO. | DESCRIPTION |
|----------|-------------|-------------------------------|
| 1 | KR-4002 | BASE |
| 2 | 839-0035 | PWR AMP DC 12V 10W |
| 3 | 560-5095 | PWR XFMP 90-240V 100V 11V 35V |
| 4 | 421-6503 | STICKER FUSE INSTR |
| | 421-6504 | STICKER FUSE INSTR |
| 5 | 81319 | STICKER 120V |
| | 80666 | STICKER 200V |
| | 80556 | STICKER 220V |
| | 80595 | STICKER 230V |
| | 80309 | STICKER 240V |
| 6 | RA-4002 | COVER |
| 7 | SGB-3751-1 | WIRE HARN PWR SPLY |
| | 211-0085 | CONN PLUG AMP 2P BROWN |
| | 211-0097 | CONN PLUG AMP 3P RED |
| | 211-0080 | CONN CAP AMP 2P BROWN |
| | 211-0060 | CONN CAP AMP 3P WHITE |
| | 211-0082 | CONN CAP AMP 4P BROWN |
| | 211-0123 | CONN CAP AMP 4P YELLOW |
| | 212-5076 | CONN FEM 4P |
| | 212-5034 | CONN FEM 6P |
| | 212-5067 | CONN FEM 8P |
| | 211-5101 | CONN FEM 10P |
| | 211-0117 | CONN CAP AMP 2P YELLOW |
| | 270-5016 | FERRITE SLEEVE CORE |
| | 211-0116 | CONN CAP AMP 2P ORANGE |
| 101 | 117-0184 | TERMINAL PLATE IL 4P |
| 102 | 117-5131 | TERMINAL PLATE 5P |
| 103 | 150-0173 | CAP E 4700 MF 50V C-TYPE |
| 104 | 400-5055 | SW REGU 90-240V 5V 10A |
| 105 | 481-0157 | DIODE BRIDGE S5VB20 |
| 106 | 514-0064 | FU HLDR 2P W/COVER |
| 107 | 514-0065 | FU HLDR 1P W/COVER |
| 108 | 514-0036 | FU 3A 6.4×30mm |
| | 514-0034 | FU 5A 6.4×30mm |
| 109 | 514-0040 | FU 4A 6.5×30mm |
| 110 | 514-0031 | FU 6A 6.5×30mm |
| 111 | 601-0429 | NOISE FLTR AC 250V 4A |
| 112 | 601-0769 | STAPLE MAX #3 |
| 113 | 280-0419 | HARNES LUG |
| 114 | 211-0167 | TERMINAL LUG ROUND ID 5 |
| 115 | 211-0041 | CONN PIN AMP |
| 116 | 211-0042 | CONN SOCKET AMP |
| 117 | 211-0005 | CONN CLAMP LOCK |
| 118 | 211-5047 | CONTACT |
| 119 | 280-5015 | FASTON RCPT 187 |
| 120 | 280-0472 | FASTON RCPT 110 |
| 121 | 150-0265 | CAP E 22000 MF 25V C-TYPE |
| 201 | 000-0414-FS | M SCR PH W/FS M4×14 |
| 202 | 005-3110 | W SCR RH 3.1×10 |
| 203 | 005-3113-F | W SCR RH W/F 3.1×13 |
| 204 | 005-3120 | W SCR RH 3.1×20 |

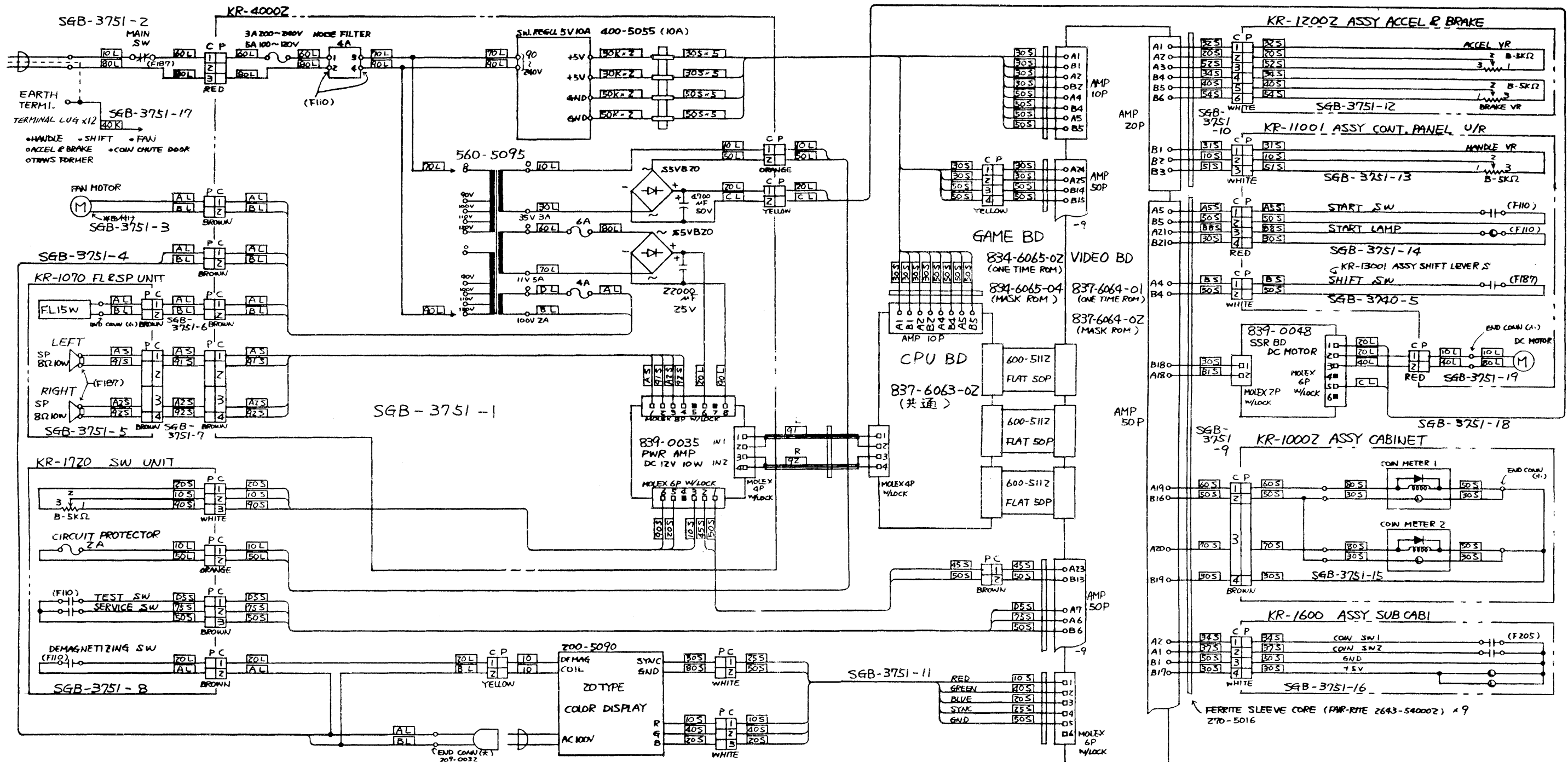

15. WIRING DIAGRAM

SEGA ENTERPRISES, LTD.
No. 2-12, Haneda 1-chome
Ohta-ku, Tokyo 144, Japan
○ **Tel. : (03) 743 - 7438**
○ **FAX : (03) 743 - 5539**
○ **TLX : J22357 SEGASTAR**

© SEGA 1986

Printed in Japan