



SEGA[®]

**SUPER
MASTERS**

OWNER'S MANUAL

SEGA ENTERPRISES, LTD.

420-0009J

TABLE OF CONTENTS

Introduction to the Owner's Manual	1
1. Handling Precautions	2
2. Prevention of Counterfeiting and Conversion	2
3. Precautions Concerning the Place of Installation	3
4. Disk Installation	4
5. Name of Parts	5
6. Adjustment of the Service Switch	6
7. Servicing the Power Supply Unit and Fuse	7
8. P.C. Board Assembly	7
9. Servicing the Floppy Disk	8
10. Drawing of P.C. Board Assembly	9
11. P.C. Board Component Locations	10
12. Monitor Adjustments and Game Board Servicing	11
13. Adjustment Instruction Switch Setting Sheet	12
14. Parts List	13
15. Schematic Diagram	14

SPECIFICATIONS

INSTALLATION SPACE	: 31 in. x 27 in.
HEIGHT	: 73 in.
POWER	: 225 W
C.R.T.	: 19" MONITOR MR
WEIGHT	: 300 lbs.

NOTE

- Descriptions herein contained may be subject to improvement changes without notice.

INTRODUCTION TO THE OWNER'S MANUAL

SEGA ENTERPRISES, LTD., supported by its high electronic technology of LSIs, microprocessors, etc. and a wealth of experience, has for more than 30 years been supplying various innovative and popular game machines to the world market. This OWNER'S manual is intended to provide detailed comments together with all the necessary information covering the operation in general of electronic assemblies, electromechanicals, servicing control, spare parts, etc. as regards the SUPER MASTERS, a new SEGA product. The manual is intended for those who have knowledge of electricity and technical expertise especially in ICs, CRTs, microprocessors, etc. Carefully read so as to acquire sufficient knowledge before working on the machine. Should there be a malfunction, non-technical personnel should under no circumstances touch the interior system.

1. HANDLING PRECAUTIONS

When installing or inspecting, be very careful of the following points and pay attention to ensure that the player can enjoy the game safely.

- Be sure to turn the power off before working on the machine.
- To insert or pull out the plug quickly is dangerous.
- It is necessary to make sure that the power cord or the grounding wire is not exposed on the road, etc. in a manner so as to be dangerous. Make sure that grounding connections are made safely at the position where so specified.
- Do not use any fuse that does not meet the specified rating.
- Make complete connections for the IC board and other connectors. Insufficient insertion is very dangerous.
- For protection of the disk, please remove from machine prior to relocation.

Also, for the IC board circuit inspections, only the logic tone is allowed. The use of a tester is not permitted, so be careful in this regard. After confirming that there are no irregularities, turn the power ON.

2. PREVENTION OF COUNTERFEITING AND CONVERSION

LABELLING

To prevent counterfeits and conversions, the following labels are put on all the SEGA products. When handling such goods, be sure to confirm the labels. They are used to prevent illegal acts such as the unauthorized copying of the products and the printed circuit boards thereof or carrying on business by manufacturing similar merchandise or by converting, selling or using such products or printed circuit boards.

ORIGINAL SEAL

The following seal is put on the machines manufactured by SEGA.



LICENSE SEAL

The following seal is put on the kits, such as the printed circuit boards, of SEGA products.



COPYRIGHT NOTICE

This SEGA product has the copyright notice as follows:

© SEGA 1989

This signifies that this work was disclosed in 1989 and is the property of SEGA ENTERPRISES, LTD.

3. PRECAUTIONS CONCERNING THE PLACE OF INSTALLATION

The SUPER MASTERS is an indoor game machine. Absolutely do not install it outside. Even indoors, avoid installing in places mentioned below so as to ensure proper usage:

- Places subject to rain or water leakage, or condensation due to humidity.
- In the proximity of an indoor swimming pool and/or shower.
- Places subject to direct sunlight.
- Places subject to heat sources from heating units, etc., or hot air.
- Vicinity of highly inflammable/volatile chemicals or hazardous matter.
- Sloped surfaces.
- Vicinity of anti-disaster facilities such as fire exits and fire extinguishers.
- Places subject to any type of violent impact.
- Dusty places.

4. DISK INSTALLATION

IMPORTANT

INSTALLATION INSTRUCTIONS

SUPER MASTERS contains a revolutionary new memory system for video games. This memory system is a Floppy Disk System which is housed in the RF Cage. This system allows Sega to give you more memory at a cost effective price.

To insure that no damage occurs to this delicate system during transit, we have packaged the Floppy Disk separately which must be installed upon receipt of the game. Please follow the listed instruction for the installation of the disk.

DISK INSTALLATION

1. Open Coin Door and remove Cash Box.
2. Open Cash Box and remove Floppy Disk. (NOTE: It is housed in a plastic protection cover.)
3. Reach thru the Coin Door opening and unlatch the two spring latches which hold the Control Panel securely to the game. These latches are located on the left and right, inside of the Control Panel Assembly.
4. Once the two latches are unlocked, open the Control Panel and pull out the drawer for access to the PCB RF Cage. (Note: Be sure not to over-extend the drawer.)
5. Remove the cover of the PCB RF Cage by removing the four sheet metal screws.
6. Remove the two screws securing the base of the PCB Assembly.
7. Lift the front side of the PCB Assembly. This will allow access to the disk drive, which is located underneath the PCB.
8. Remove the disk from the plastic protection case and install it into the disk drive label side up with the metal cover protection slide installed first. The disk should slide in and snap down to indicate that it is securely inserted.
9. Replace the two screws that you removed in Step #7 to secure the Wooden PCB base to the RF Cage.
10. Replace the lid of the RF Cage using the four sheet metal screws that were removed from the assembly in Step #6.
11. Push the drawer back into place, and close and latch the Control Panel.
12. Apply power to the game and verify proper operation. This completes the Drive Assembly.
13. For protection of the disk, please remove it from the machine prior to relocation.

5. NAME OF PARTS

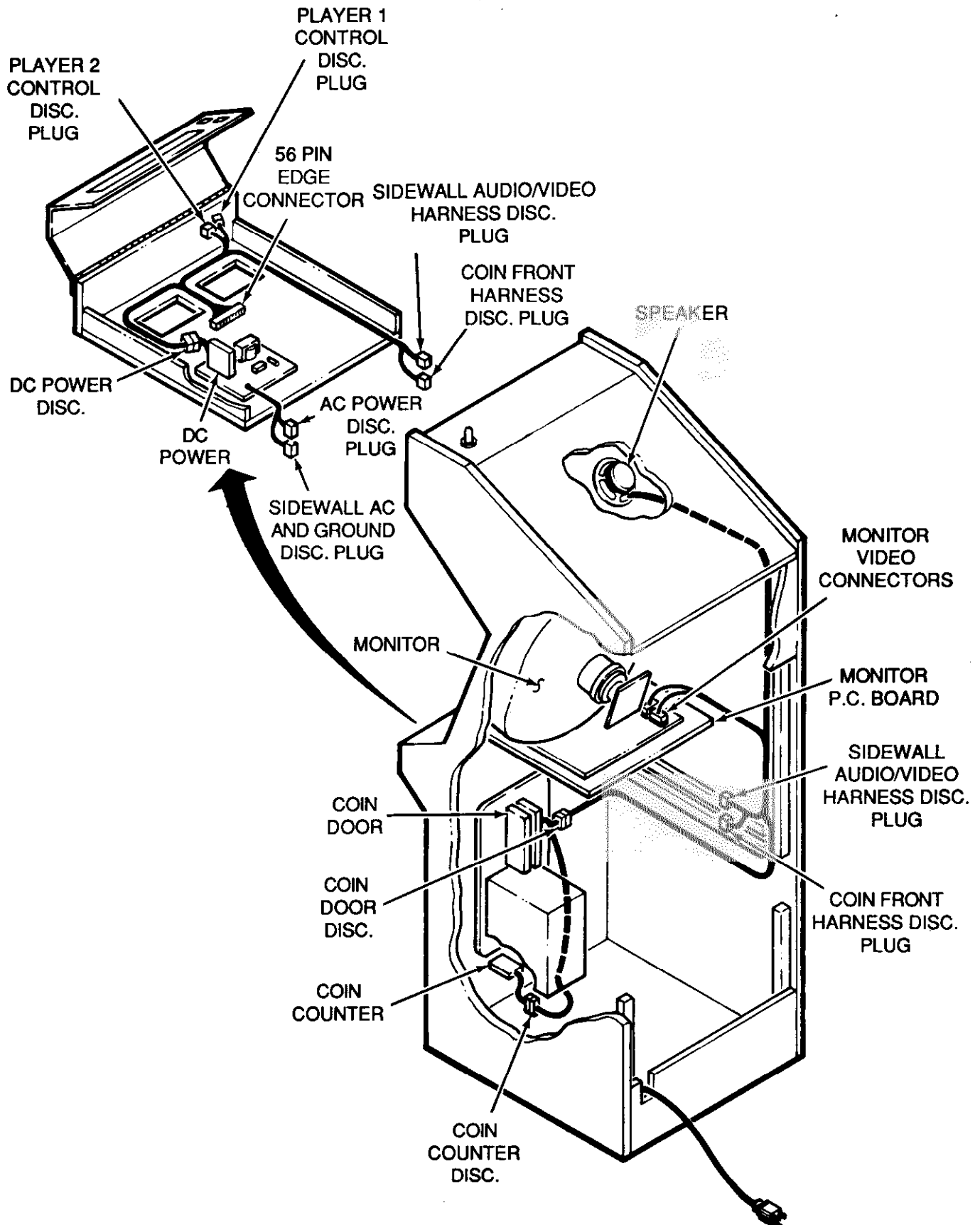

6. ADJUSTMENT OF THE SERVICE SWITCH

The layout as shown below can be viewed by opening the coin chute door.

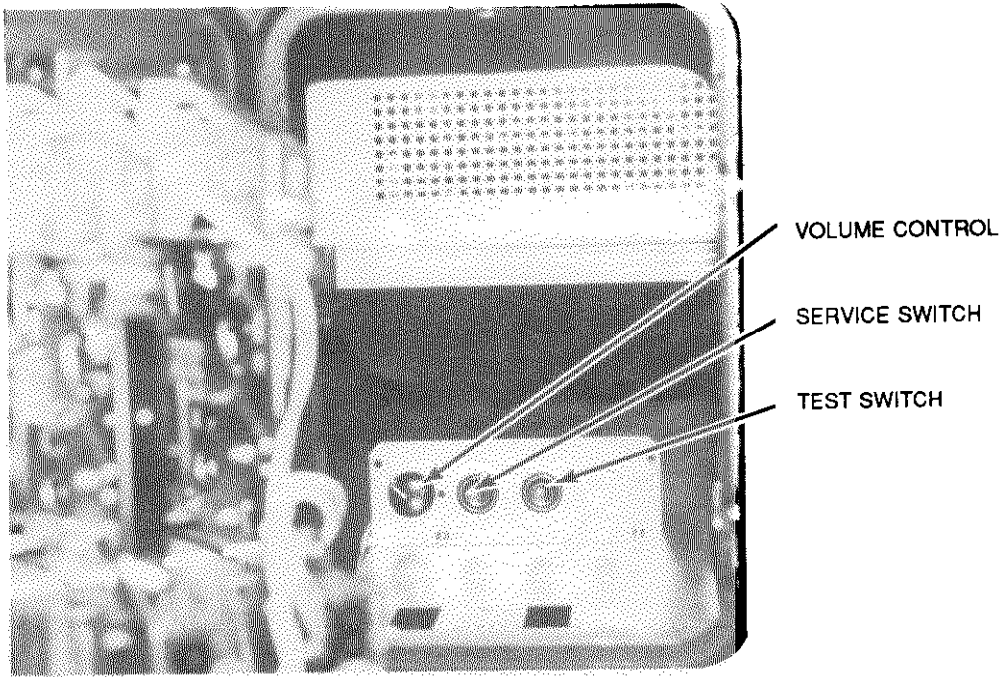

OPERATING INSTRUCTIONS

SERVICE SWITCH Used for the purpose of servicing and increasing the credits without registering on the meter (this allows you to check the game).

TEST SWITCH For operating this switch, see SELF-TESTING.

VOLUME CONTROL Potentiometer Adjustment

7. SERVICING THE POWER SUPPLY UNIT AND FUSE

Power Supply Assembly

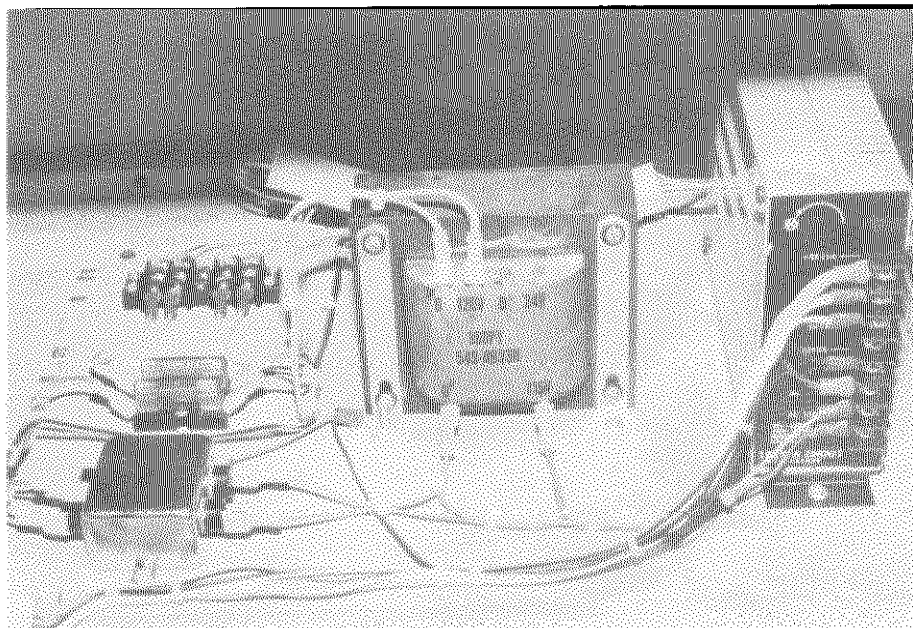

8. P.C. BOARD ASSEMBLY

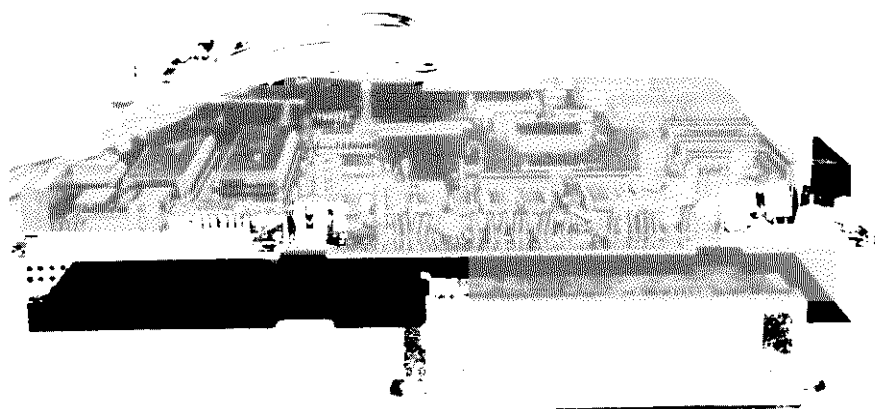

9. SERVICING THE FLOPPY DISK

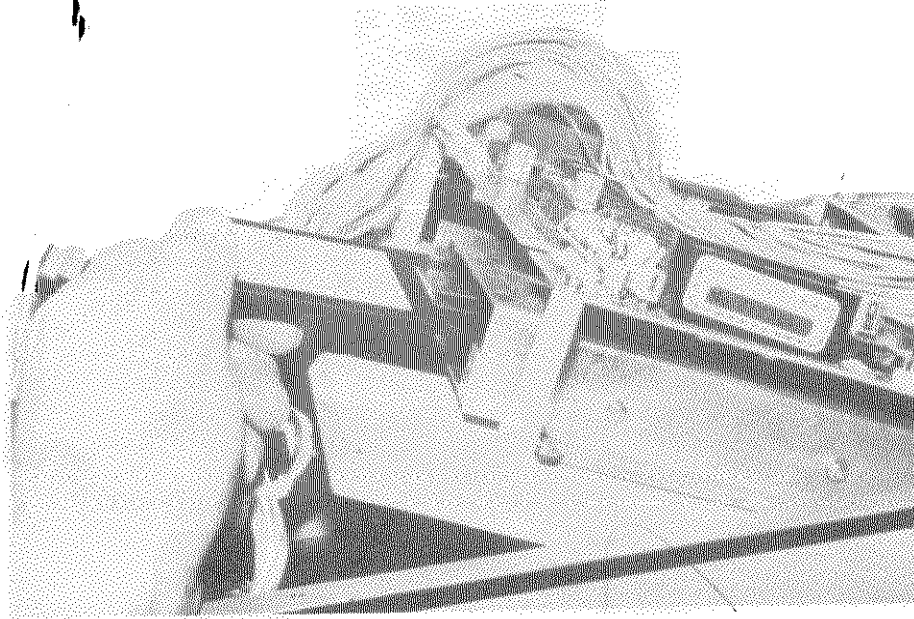

REMOVE THE LID of the SHIELD CASE. Remove the sheet metal and pull out the game board unit in a manner so that both ends of it will meet the shield case. Open the FDD (Floppy Disk Drive) LID by taking off the 2 (M3 x 8) SCREWS when replacing the FLOPPY DISK.

10. DRAWING OF PC ASSEMBLY

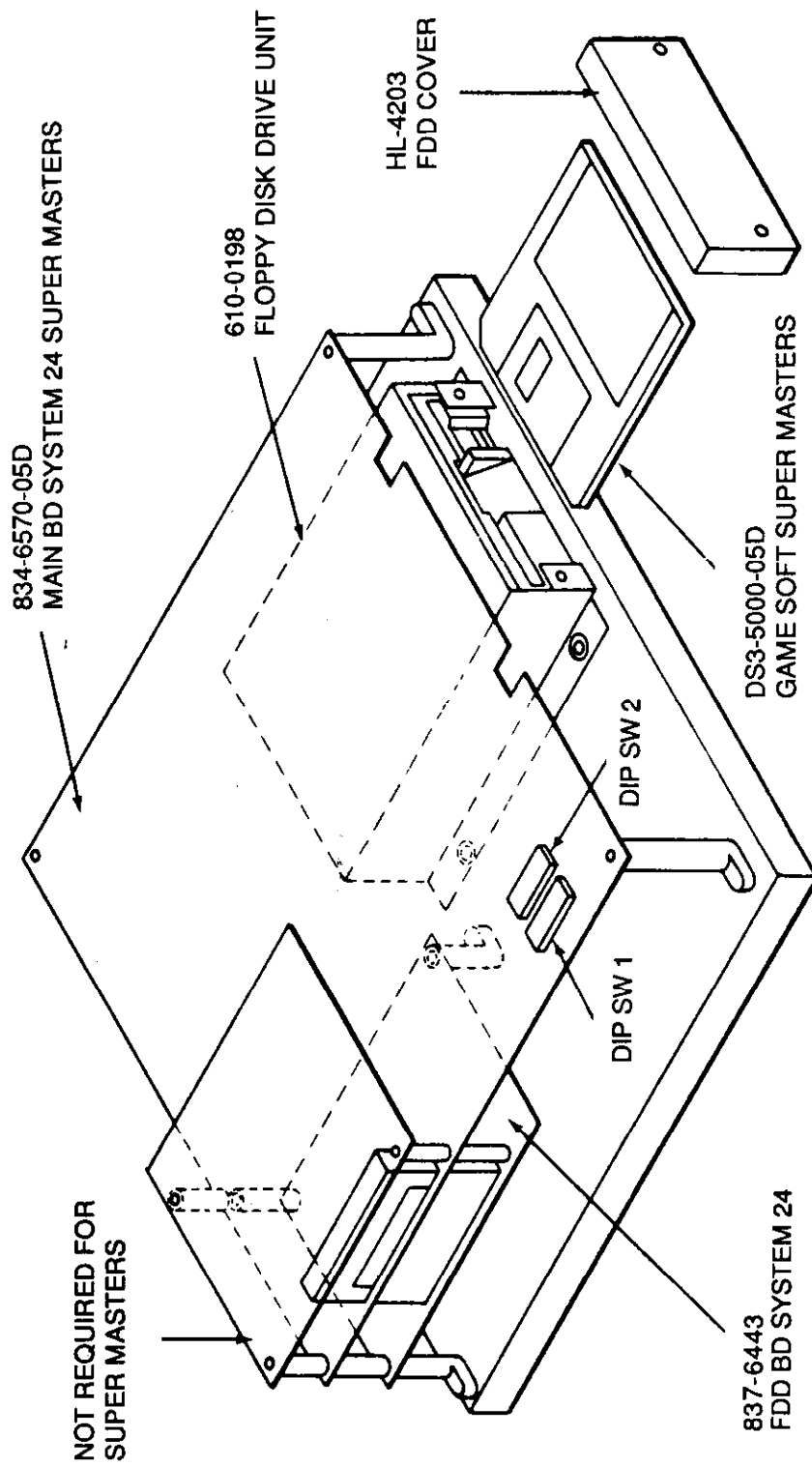

11. PC BOARD COMPONENT LOCATIONS

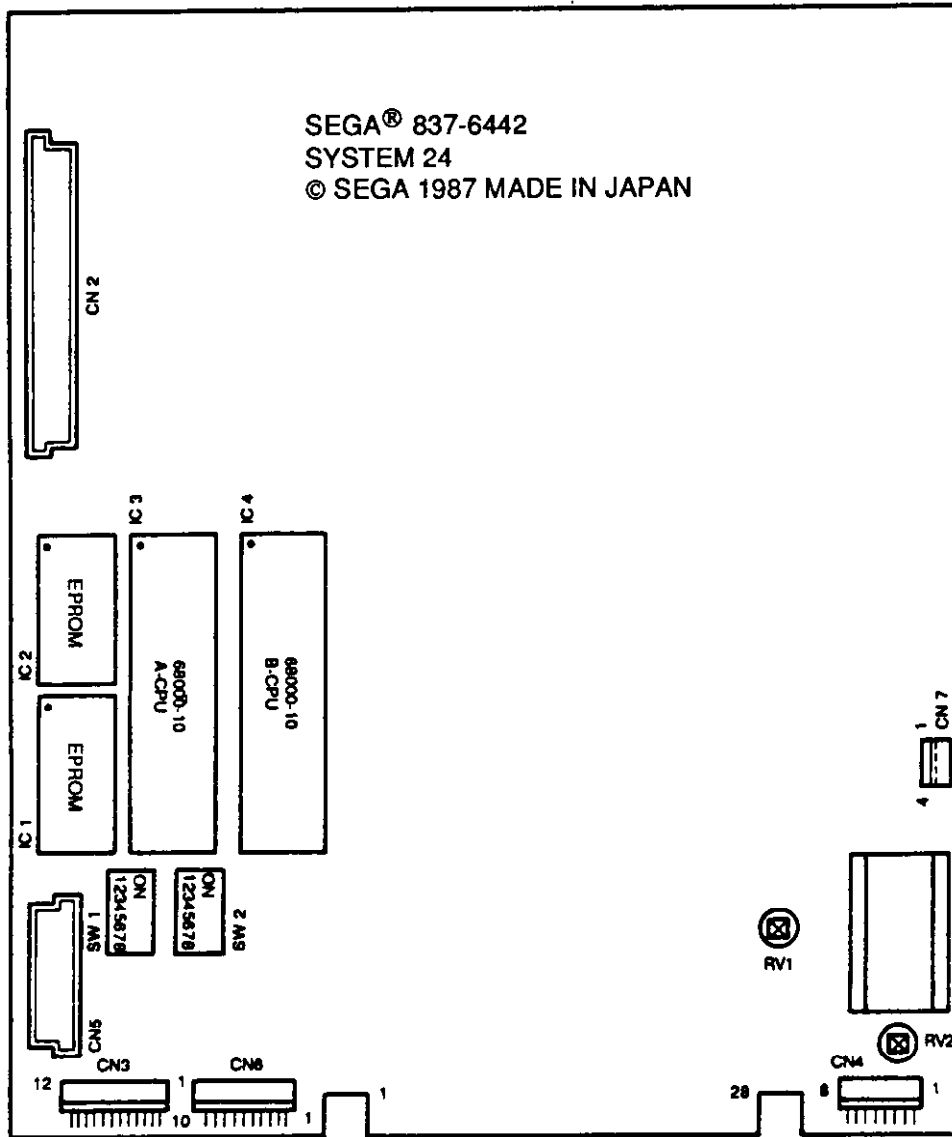

MAIN BD SY 24

- IC 1 EPROM (IC MB27C1000-15) FOR SYSTEM
- IC 2 EPROM (IC MB27C1000-15) FOR SYSTEM
- IC 3 IC 68000
- IC 4 IC SECURITY CPU 68000 OR IC 68000 FOR GAME PROGRAM

- SW 1 DIP SW
- SW 2 DIP SW
- CN 3 DATA COMMUNICATION CONNECTOR
- CN 6 RESERVE POWER CONNECTOR
- CN 7 INPUT (SOUND) CONNECTOR
- CN 8 HEADPHONE OUTPUT CONNECTOR
- RV 1 MAIN SOUND VOLUME
- RV 2 HEADPHONE SOUND VOLUME

12. MONITOR ADJUSTMENT AND GAME BOARD SERVICING

Monitor Adjustment

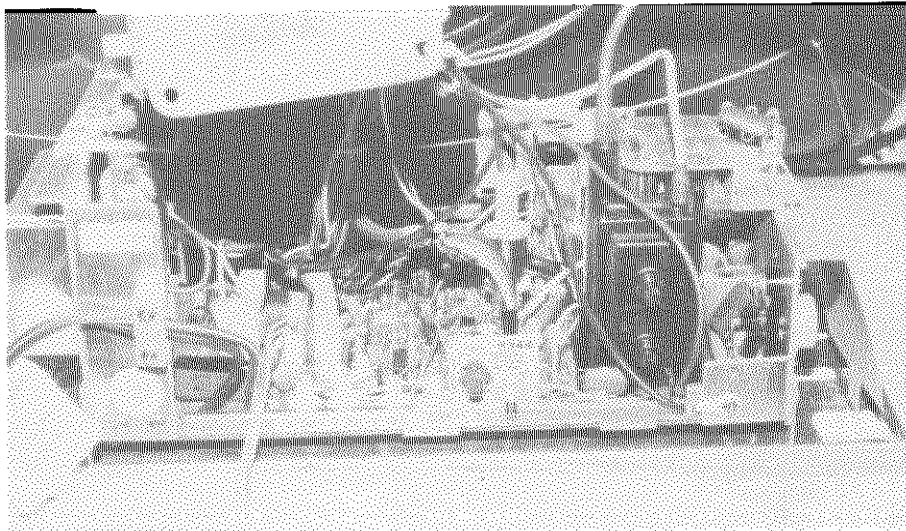

Super Masters Printed Circuit Board

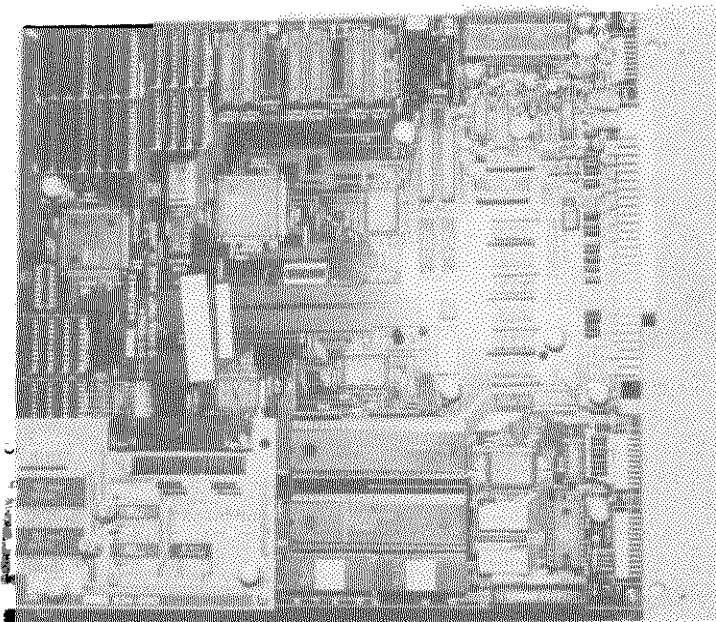

13. ADJUSTMENT INSTRUCTION SWITCH SETTING SHEET

COIN/CREDIT OPTION SWITCH SETTING

DIP SW #1

OPTION		1	2	3	4	5	6	7	8
1 COIN	1 CREDIT	OFF	OFF	OFF	OFF	OFF	OFF	OFF	OFF
1 COIN	2 CREDITS	ON	OFF	OFF	OFF	ON	OFF	OFF	OFF
1 COIN	3 CREDITS	OFF	ON	OFF	OFF	OFF	ON	OFF	OFF
1 COIN	4 CREDITS	ON	ON	OFF	OFF	ON	ON	OFF	OFF
1 COIN	5 CREDITS	OFF	OFF	ON	OFF	OFF	OFF	ON	OFF
1 COIN	6 CREDITS	ON	OFF	ON	OFF	ON	OFF	ON	OFF
2 COINS	1 CREDIT	OFF	ON	ON	OFF	ON	ON	ON	OFF
2 COINS	2 CREDITS	ON	ON	ON	OFF	ON	ON	ON	OFF
4 COINS	1 CREDIT	OFF	OFF	OFF	ON	OFF	OFF	OFF	ON
4 COINS	3 CREDITS	ON	OFF	OFF	ON	ON	OFF	OFF	ON
2 COINS	3 CREDITS	ON	OFF	OFF	ON	ON	OFF	OFF	ON
2 COINS	1 CREDIT	OFF	ON	OFF	ON	OFF	ON	OFF	ON
4 COINS	2 CREDITS	OFF	ON	OFF	ON	OFF	ON	OFF	ON
5 COINS	3 CREDITS	OFF	ON	OFF	ON	OFF	ON	OFF	ON
6 COINS	4 CREDITS	OFF	ON	OFF	ON	OFF	ON	OFF	ON
2 COINS	3 CREDITS	ON	ON	OFF	ON	ON	ON	OFF	ON
4 COINS	3 CREDITS	ON	ON	OFF	ON	ON	ON	OFF	ON
1 COIN	1 CREDIT	OFF	OFF	ON	ON	OFF	OFF	ON	ON
2 COINS	2 CREDITS	OFF	OFF	ON	ON	OFF	OFF	ON	ON
3 COINS	3 CREDITS	OFF	OFF	ON	ON	OFF	OFF	ON	ON
4 COINS	4 CREDITS	OFF	OFF	ON	ON	OFF	OFF	ON	ON
5 COINS	6 CREDITS	OFF	OFF	ON	ON	OFF	OFF	ON	ON
1 COIN	1 CREDIT	ON	OFF	ON	ON	ON	OFF	ON	ON
2 COINS	2 CREDITS	ON	OFF	ON	ON	ON	OFF	ON	ON
3 COINS	3 CREDITS	ON	OFF	ON	ON	ON	OFF	ON	ON
4 COINS	5 CREDITS	ON	OFF	ON	ON	ON	OFF	ON	ON
1 COIN	1 CREDIT	OFF	ON	ON	ON	OFF	ON	ON	ON
2 COINS	3 CREDITS	OFF	ON	ON	ON	OFF	ON	ON	ON
FREE PLAY		ON	ON	ON	ON	ON	ON	ON	ON
---		COIN SW. #1				COIN SW. #2			

SUPER MASTERS
(834-6570-05D)

BARE BD NO.
171-5553, 171-5553-01

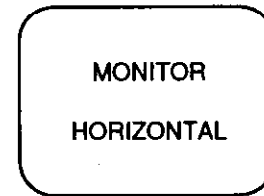
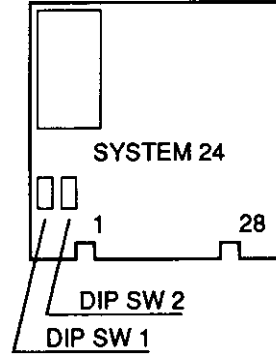

GAME OPTION SWITCH SETTING

DIP SW #2

		1	2	3	4	5	6	7	8
1 CREDIT TO START		OFF							
2 CREDITS TO START (1 CREDIT TO CONTINUE)		ON							
ADVERTISE SOUND	OFF		OFF						
	ON		ON						
MONITOR FLIP	OFF			OFF					
	ON			ON					
* GAME RULE	1 CREDIT 1 HOLE				OFF				
	LOSE BALL GAME OVER				ON				
NOT USED						OFF			
* GAME DIFFICULTY	NORMAL						OFF	OFF	OFF
	EASY 1						ON	OFF	OFF
	EASY 2						OFF	ON	OFF
	EASY 3						ON	ON	OFF
	HARD 1						OFF	OFF	ON
	HARD 2						ON	OFF	ON
	HARD 3						OFF	ON	ON
HARD 4						ON	ON	ON	
* GAME RULE	1 CREDIT 1 HOLE	Player must get birdy or better score to advance next hole otherwise Game over.							
	LOSE BALL GAME OVER	1 credit 2 balls. If player makes par or better, he gets one ball (Life). If worse than par he will lose a ball. Balls can be held up to 3 balls. If he runs out of balls, Game over.							

PIN ASSIGNMENT

COMPONENT SIDE		SOLDER SIDE
GND	1 A	GND
GND	2 B	GND
+5V	3 C	+5V
+5V	4 D	+5V
+12V	5 E	+12V
COIN METER 1	6 F	COIN METER 2
(NOT USED)	7 H	(NOT USED)
ANGLE LEFT	8 J	(NOT USED)
CLUB SELECT	9 K	(NOT USED)
ANGLE RIGHT	10 L	(NOT USED)
STANCE SELECT	11 M	(NOT USED)
SWING D0	12 N	(NOT USED)
SWING D1	13 P	(NOT USED)
SWING D2	14 R	(NOT USED)
SWING D3	15 S	(NOT USED)
SWING D4	16 T	(NOT USED)
SWING D5	17 U	(NOT USED)
(NOT USED)	18 V	(NOT USED)
(NOT USED)	19 W	(NOT USED)
COIN 1	20 X	1P START
COIN 2	21 Y	2P START
TEST	22 Z	(NOT USED)
SERVICE	23 a	(NOT USED)
SPEAKER (+)	24 b	SPEAKER (-)
RED	25 c	GREEN
BLUE	26 d	CMP. SYNC
GND	27 e	GND
GND	28 f	GND

* GAME DIFFICULTY = EASY1<EASY2<EASY3<NORMAL<HARD1<HARD2<HARD3<HARD4

14. PARTS LIST

PART NUMBER	DESCRIPTION	QTY
117-5123	NAME PLATE, ELEC SPEC	1
200-5090-MR	MONITOR, 19" FRONT MED RES	1
390-5120	LAMP, FLUOR	1
390-5120-1	FIXTURE, FLUOR	1
420-0009U	MANUAL, SUPER MASTERS	1
421-5800-105	ORIGINAL SEAL, SUPER MASTERS	1
421-6709	STICKER, SVC. INST.	1
421-7209-01	STICKER, FDD COVER	1
423-0040U	MARQUEE PLEX, SUPER MASTERS	1
423-0041U	MONITOR CARD, SUPER MASTERS	1
423-0042U	OVERLAY, CTRL PNL, SUPER MASTERS	1
423-0043U	DECAL, SIDE (L), SUPER MASTERS	1
423-0044U	DECAL, SIDE (R), SUPER MASTERS	1
475-0049	RHEOSTAT, 100 OHM 10W	1
509-0004-01	BUTTON, RED	2
509-0004-02A	BUTTON, ONE PLAYER	1
509-0004-02B	BUTTON, TWO PLAYER	1
509-0004-04	BUTTON, YELLOW	2
509-5028	SWITCH, PB MOMENTARY	2
560-5126	TRANSFORMER, 160P1	1
600-5661	CONN, FE 4PX2	1
600-5672-01	ASSY, FEM/FL CA 34P	1
600-5837	CONN, JST 16P & 9P	1
600-5849-04	WIRE HARN 56P, SUPER MASTERS	1
601-0043	KNOB, 1/8"	1
601-0420	FILTER, AC LINE	1
601-6073	RUBBER GROMMET	4
610-0198	ASSY, FDD UNIT	1
610-0244	ASSY, CLUB, SUPER MASTERS	1
834-6570-05D	GAME PCB, SYS 24 SUPER MASTERS	1
839-0207	FILTER BOARD, GF	1
DS3-5000-05D	GAME SOFT, SUPER MASTERS W/SEC	1
HL-4102	SHIELD LID	1
HL-4104	SHIELD CASE	1
HL-4203	FDD COVER	1
HL-4204	FDD LID	1
HL-4205	SASH RUBBER 110	1
HL-4206	FDD BASE	1
KRO-1721	BRACKET, SERVICE SWITCH	1
739902400	WIRE HARNESS, SUPER MASTERS	1
800300200	PLATE, LATCH SLANT DRAWER	2
800302000	ENCLOSURE, COIN HOUSING	1
800800600	PANEL, CTRL HS2 PATTERN M	1
801100600	BRACKET, MARQUEE	1
851101000	BEZEL, HS1 HS2	1
861100800	PLEX, MNTR 23-11/16 X 23-11/16	1
880300300	HOLDER, FUSE	1
880300500	FUSE, 5 AMP 250V	1
880300600	SPEAKER, 5" X 7" AMP 8H F12 F05	1
880301400	SWITCH, ON/OFF	1
880302900	POWER SUPPLY, 11 AMP	1
890300100	LEVELER, LEG	4
890300300	LATCH, HC227	2
991200900	ASSY, SLANT DRAWER	1
991701400	ASSY, MONITOR FRAME	1

SEGA ENTERPRISES, INC. (USA)

2149 Paragon Drive
San Jose, CA 95131
Tel. (408) 435-0201
©SEGA 1989

415-802 3100